

ASSEMBLY INSTRUCTION



VENDOR CODE: TXNS  
STOCK#:8170-00 SOFA

SKU#:10181713  
SKU#:10181725

MANUFACTURED FOR ROOMS TO GO

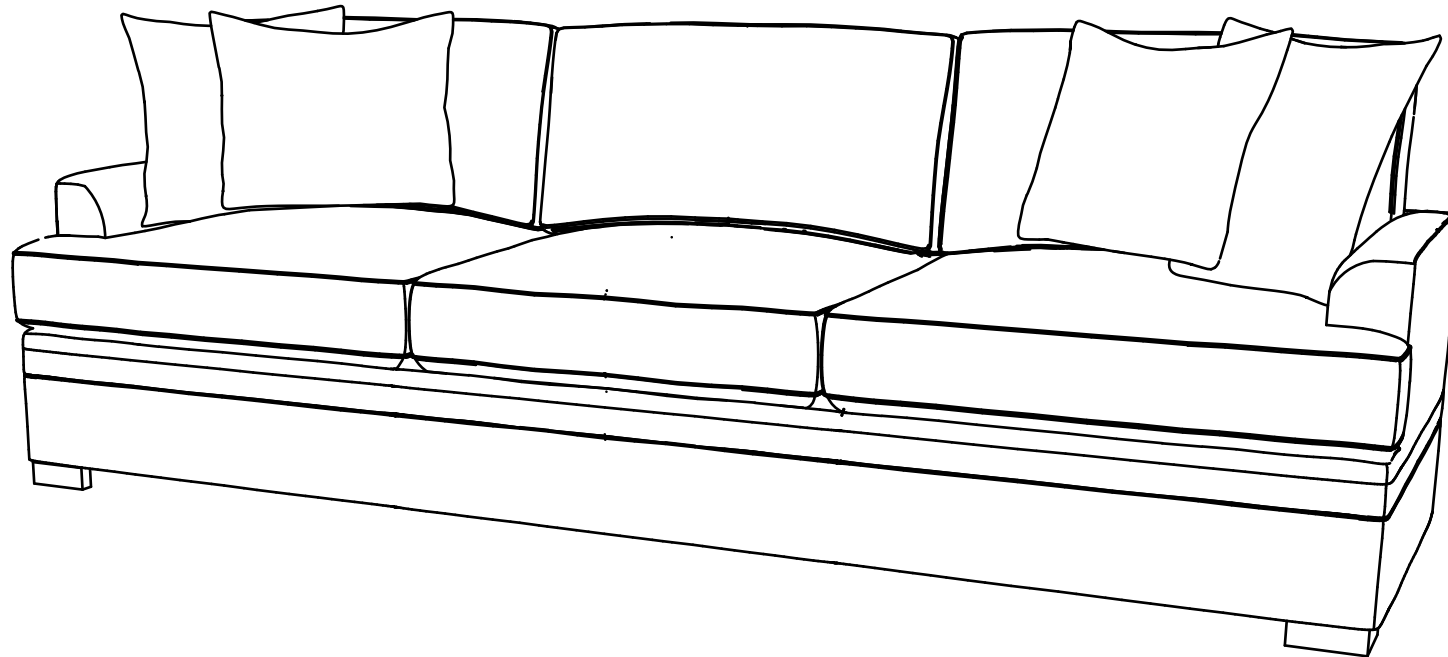









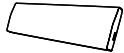
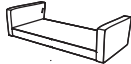

## Part Location

VENDOR CODE: TXNS  
STOCK#:8170-00 SOFA

SKU#:10181713  
SKU#:10181725

MANUFACTURED FOR ROOMS TO GO

TOOLS REQUIRED: NO			
PART LIST			
NO	Description	Sketch	Quantity
A	BACK		1
B	SEAT FRAME		1
C	BACK CUSHIONS		3
D	SEAT CUSHIONS		3
E	CORNER FEET		4
F	CENTER LEG		1
G	BOLTS 1/4"-20 x 45MM		16
H	PILLOWS		4
I	Allen Key 5/32"		1

Seat and back cushions (part C & D) are packed stacked with the back on top (part A).

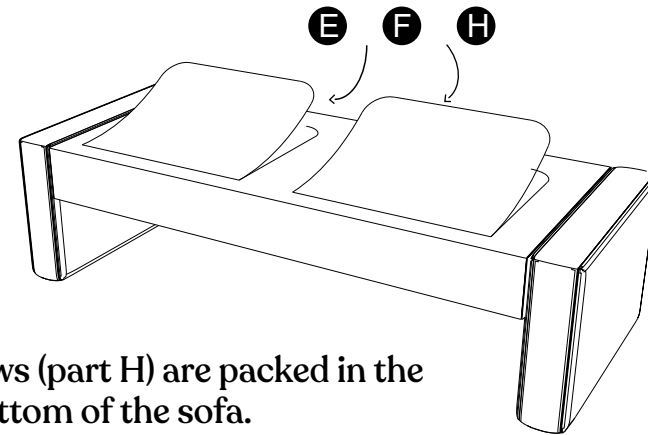
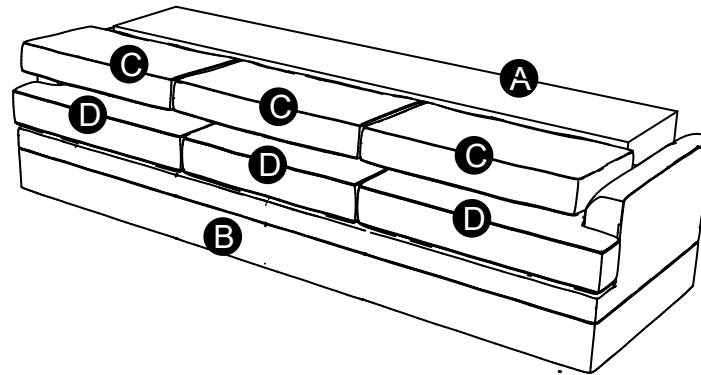

Legs (part E & F) and pillows (part H) are packed in the zippered pocket on the bottom of the sofa.



# ASSEMBLY

VENDOR CODE: TXNS  
STOCK#:8170-00 SOFA

SKU#:10181713  
SKU#:10181725

MANUFACTURED FOR ROOMS TO GO

**Step 1** Slide down backrest (part A) in brackets of arms (parts B).

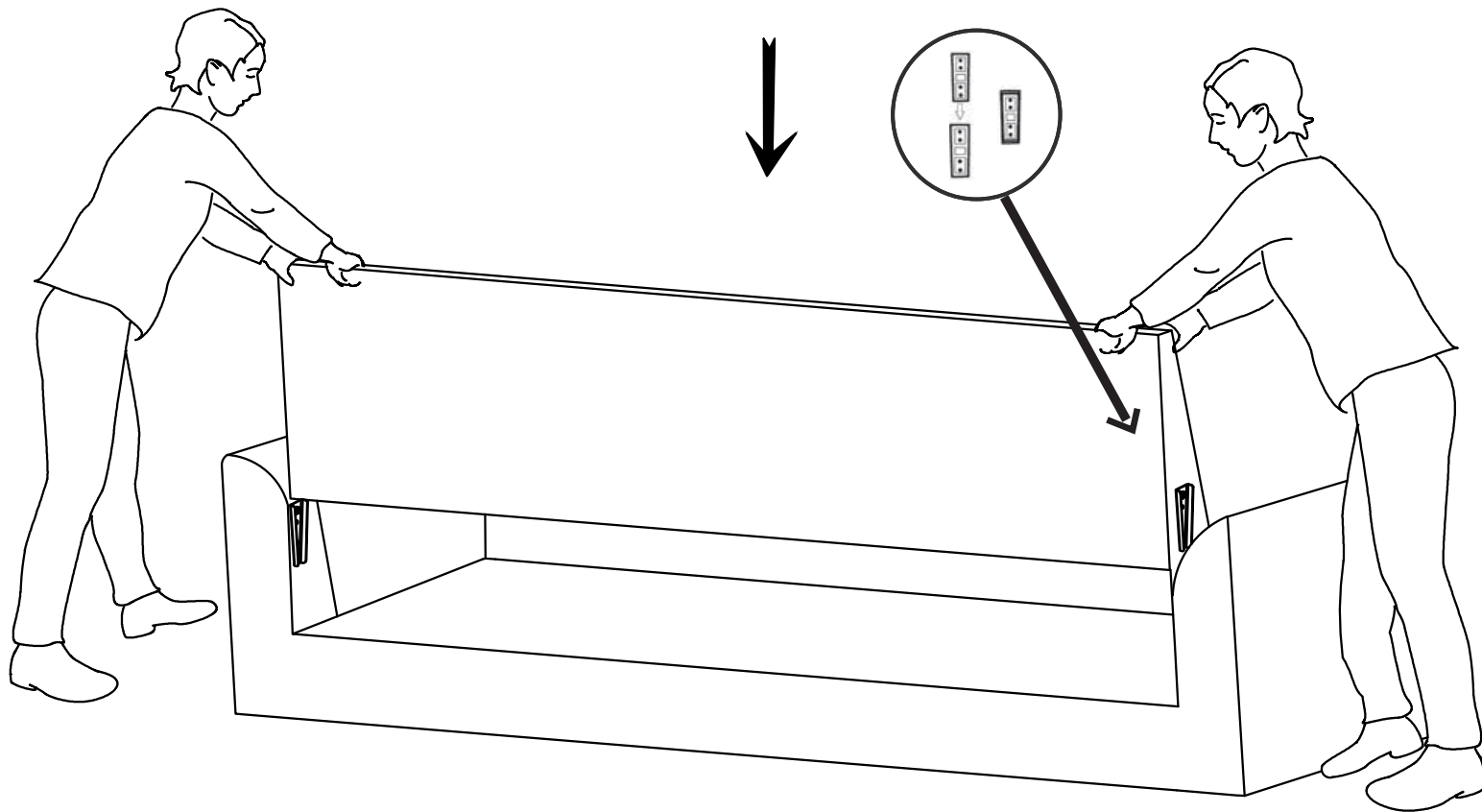



# ASSEMBLY

VENDOR CODE: TXNS  
STOCK#:8170-00 SOFA

SKU#:10181713  
SKU#:10181725

MANUFACTURED FOR ROOMS TO GO

## Step 2

Use provided allen wrench to tighten bolts (part G) through feet (part E) to base (part B). Tighten center leg (part F) to base by rotating in.

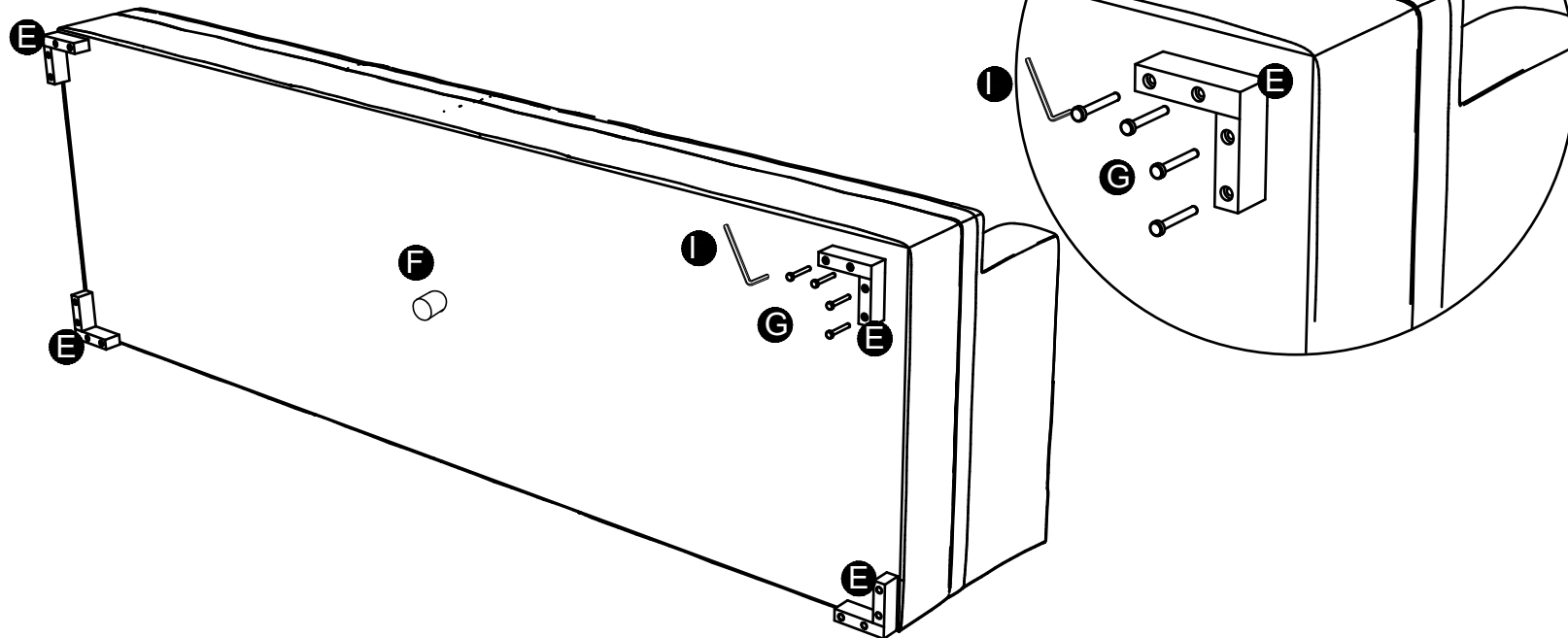



## ASSEMBLY

VENDOR CODE: TXNS  
STOCK#:8170-00 SOFA

SKU#:10181713  
SKU#:10181725

MANUFACTURED FOR ROOMS TO GO

### Step 3

Add seat cushions (parts D) and back cushions (parts E). Cushions with L shape go on outside.  
Add throw pillows (parts H) to top of seat cushions (parts D).

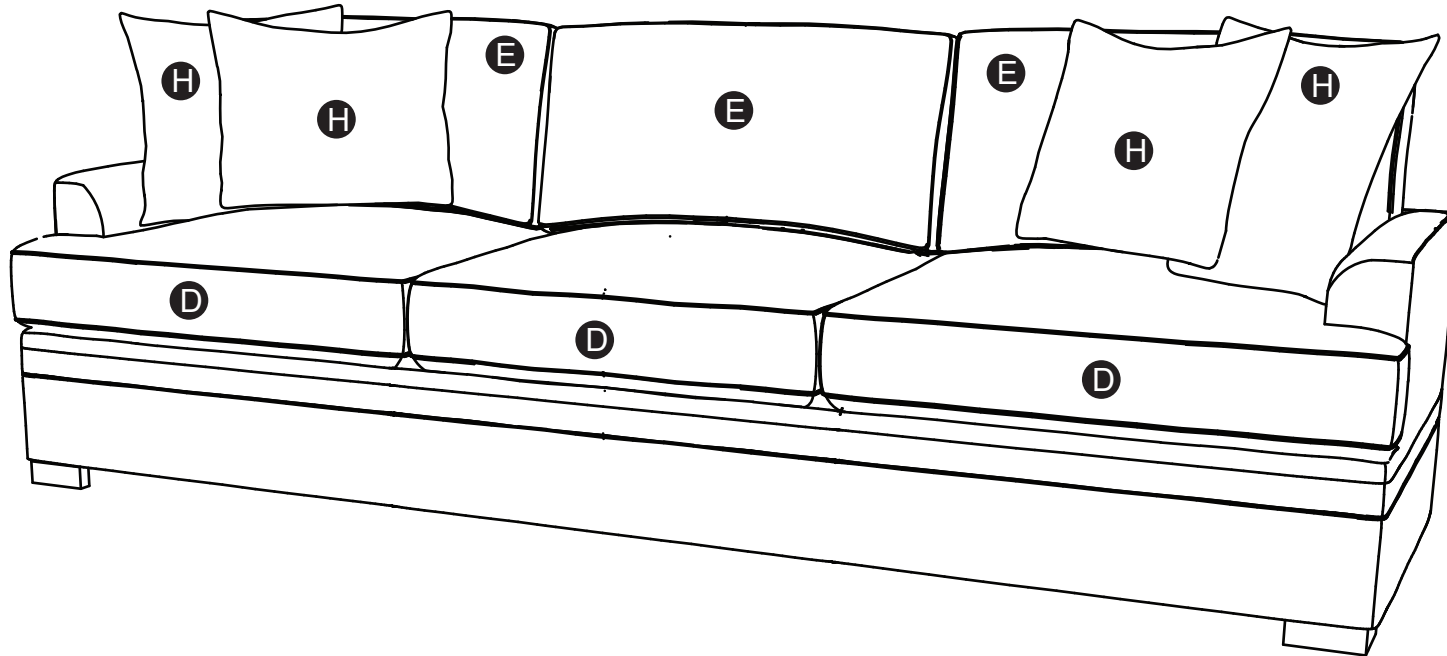

## ASSEMBLY



VENDOR CODE: TXNS  
STOCK#:8170-00 SOFA

SKU#:10181713  
SKU#:10181725

MANUFACTURED FOR ROOMS TO GO

### Step 5

Secure back flap on back (part A) to seat back (part B) by pushing down and connecting velcro to finish assembly.

