

ASSEMBLY INSTRUCTION



VENDOR CODE: TXNS  
STOCK#:8190-00 SOFA

SKU#:10181903  
SKU#:10181915

MANUFACTURED FOR ROOMS TO GO









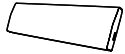
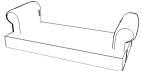

### Part Location

VENDOR CODE: TXNS  
STOCK#:8180-00 SOFA

SKU#:10181903  
SKU#:10181915

MANUFACTURED FOR ROOMS TO GO

TOOLS REQUIRED: NO			
PART LIST			
NO	Description	Sketch	Quantity
A	BACK		1
B	SEAT FRAME		1
C	BACK CUSHIONS		2
D	SEAT CUSHIONS		2
E	CORNER LEGS		1
F	CENTER LEG		1
G	PLASTIC WASHERS		4
H	PILLOWS		4

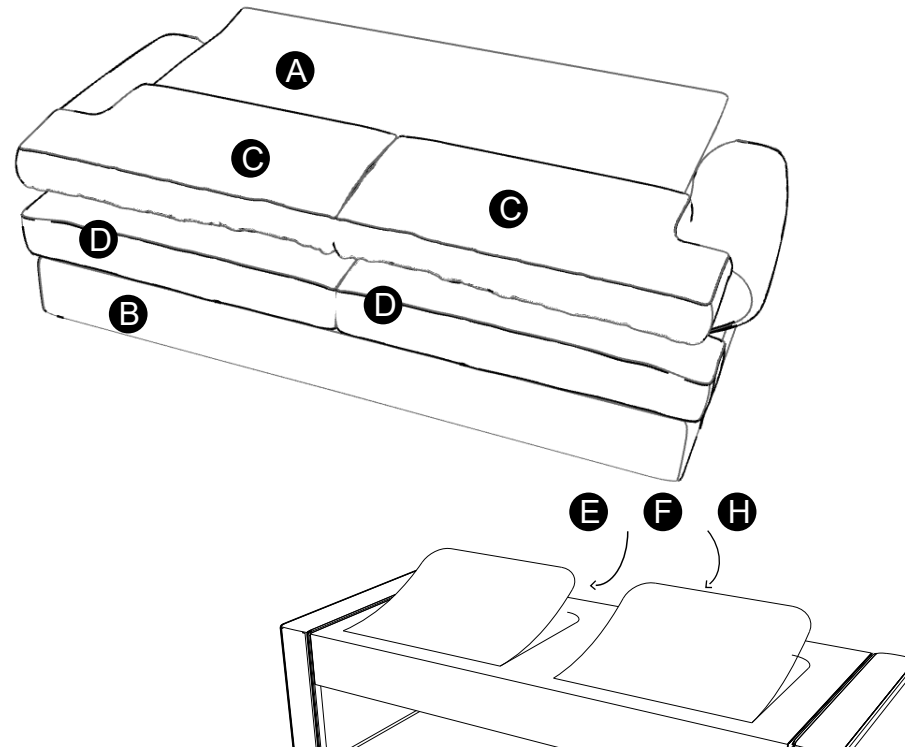

Legs (part E & F) and pillows (part H) are packed in the zippered pocket on the bottom of the sofa.



## ASSEMBLY

VENDOR CODE: TXNS  
STOCK#:8190-00 SOFA

SKU#:10181903  
SKU#:10181915

MANUFACTURED FOR ROOMS TO GO

**Step 1** Slide down backrest (part A) in brackets of arms (parts B).

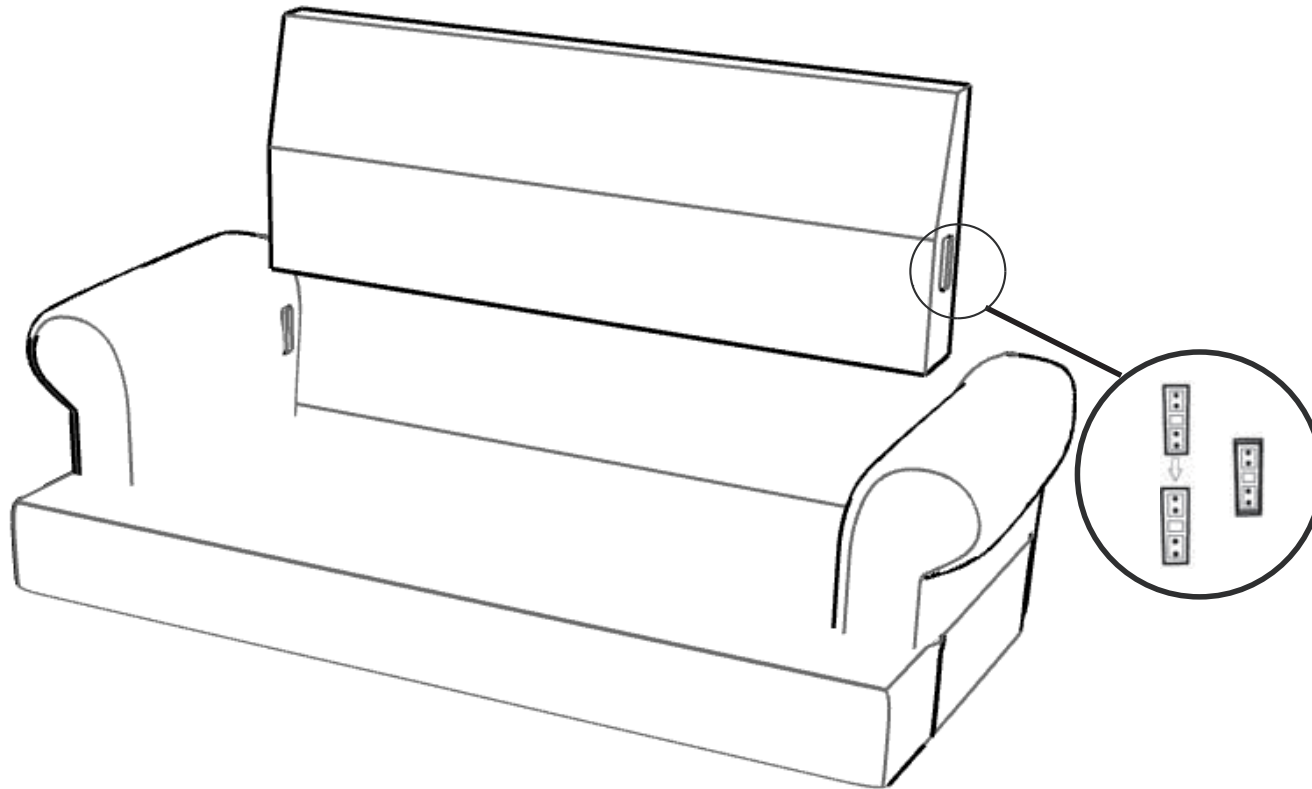



# ASSEMBLY

VENDOR CODE: TXNS  
STOCK#:8190-00 SOFA

SKU#:10181903  
SKU#:10181915

MANUFACTURED FOR ROOMS TO GO

## Step 2

Screw in corner legs (parts E) and centerleg (part F) clockwise into underside of seat (parts B)

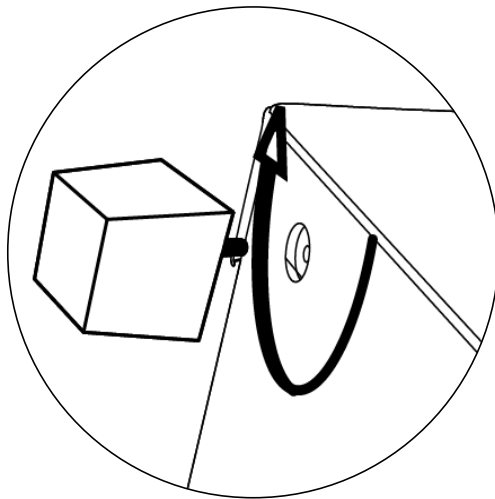

## OPTIONAL

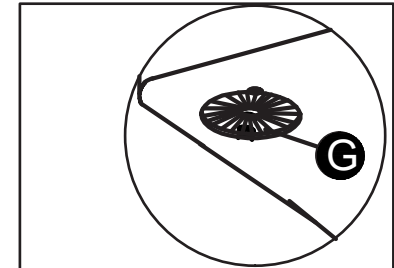

Adjust each leg by inserting a washer (G) to make it even and level with the floor.

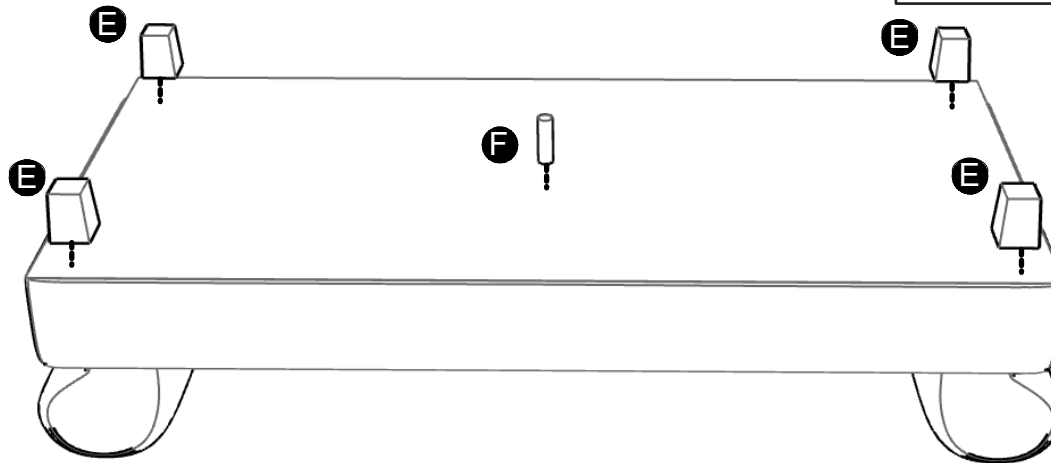



# ASSEMBLY

VENDOR CODE: TXNS  
STOCK#:8190-00 SOFA

SKU#:10181903  
SKU#:10181915

MANUFACTURED FOR ROOMS TO GO

## Step 3

Add seat cushions (parts D) and back cushions (parts E).  
Add throw pillows (parts H) to top of seat cushions (parts D).

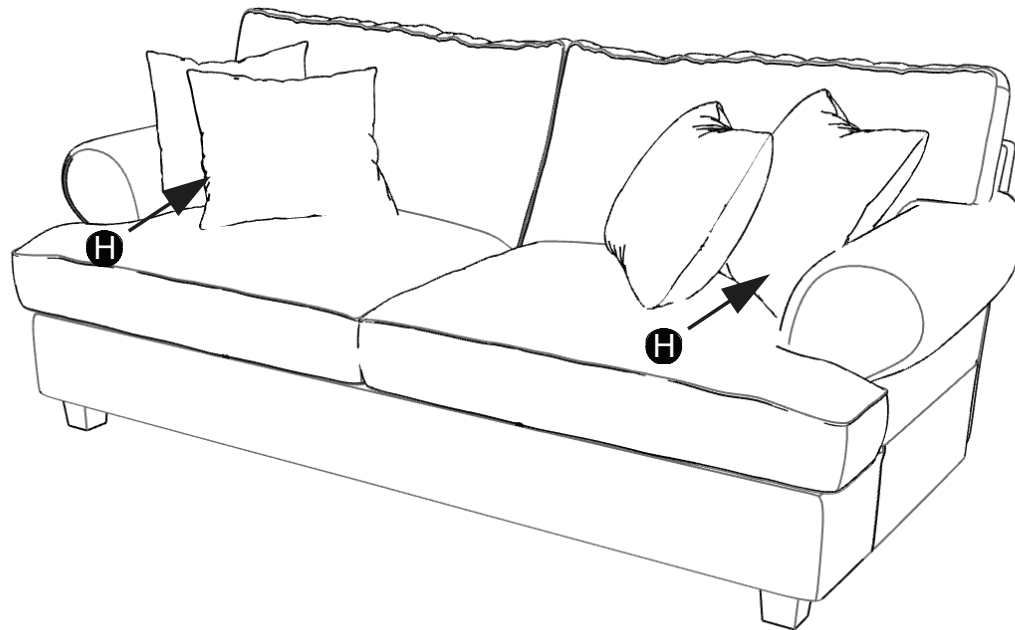
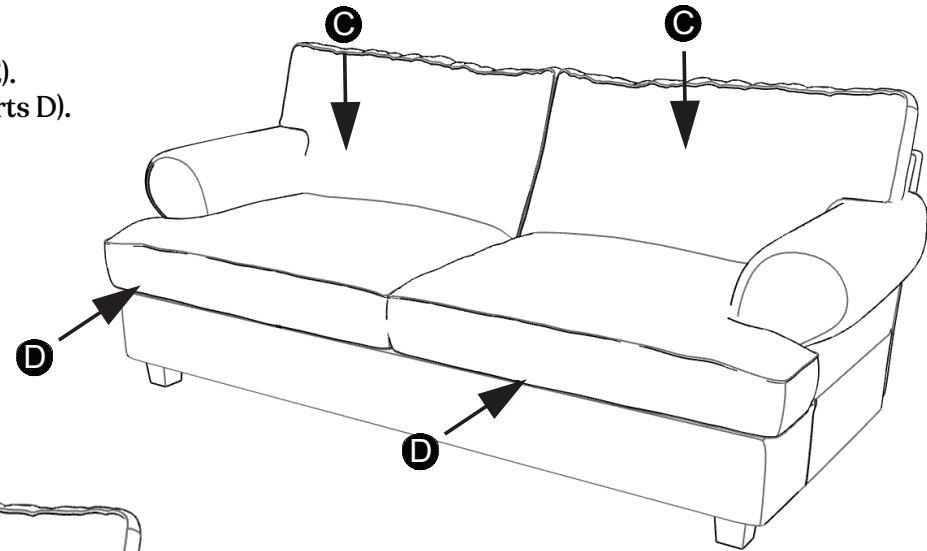

## ASSEMBLY



VENDOR CODE: TXNS  
STOCK#:8190-00 SOFA

SKU#:10181903  
SKU#:10181915

MANUFACTURED FOR ROOMS TO GO

### Step 5

Secure back flap on back (part A) to seat back (part B) by pushing down and connecting velcro to finish assembly.

