

T Ö V

FURNITURE

MYRA CHAIR  
TOV-A85/TOV-A105



# MYRA

---

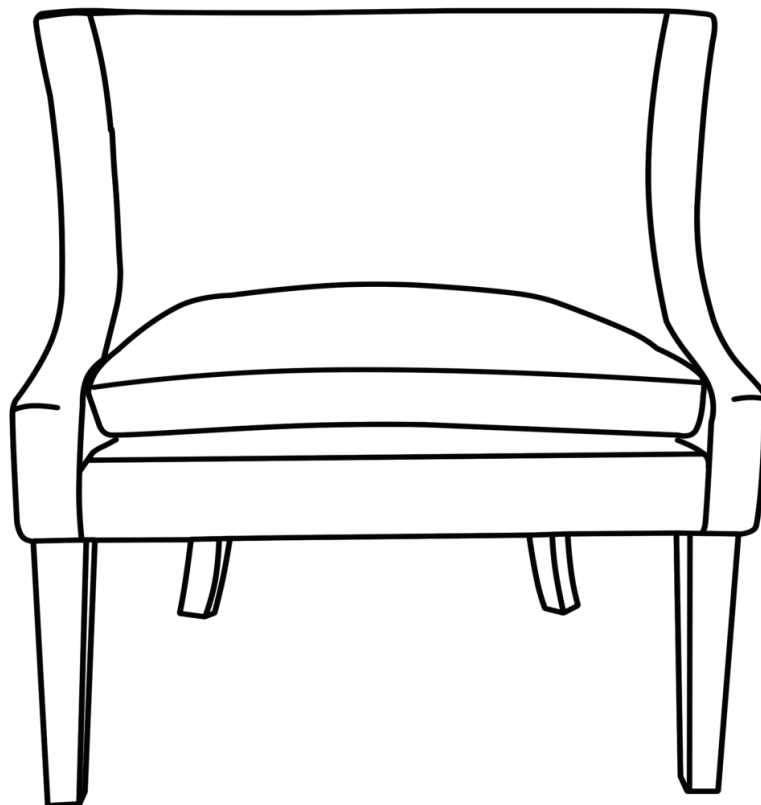



## ASSEMBLY INSTRUCTIONS



## PARTS LIST

LABEL	PICTURE	DESCRIPTION	QTY
A		Chair	1
B		Front Leg	2
C		Back Leg	2

## HARDWARE

LABEL	PICTURE	DESCRIPTION	QTY
E		Metal Gasket	10
F		Spring Washer	10
G		Screw	10
H		Wrench	1

### BEFORE BEGINNING ASSEMBLY:



*Read instructions cover to cover*



*Have two adults on hand for assembly*



*Do NOT assemble on flooring or carpet. Assemble on a clean non-marring surface (ex: packing foam)*



*Save all packaging until assembly is completed*

---

## ASSEMBLY STEPS

---

### STEP 1

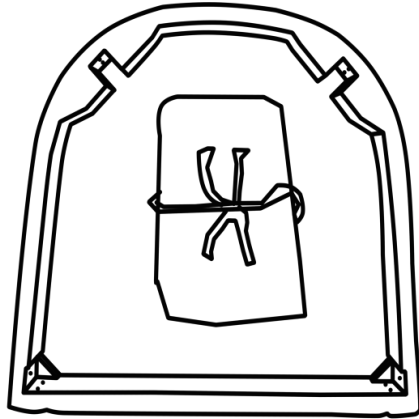

- › Position the product on its bottom as shown.
- › Open to take the four legs.

---

### STEP 2

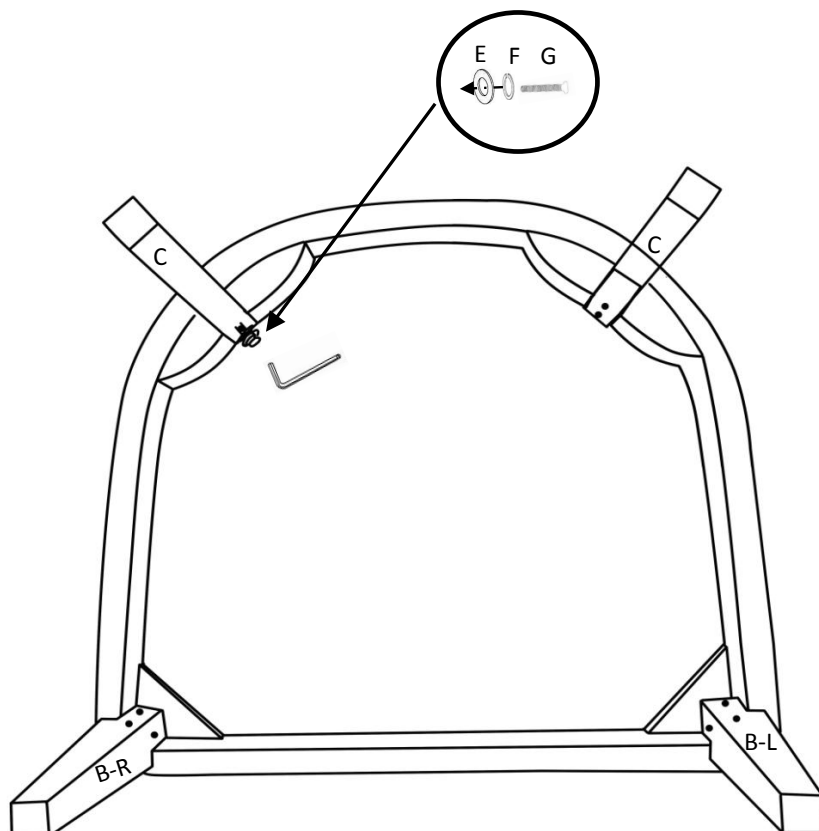

## **CARE & MAINTENANCE**



**Do not put hot items directly on furniture surface.**



**Do not clean furniture with harsh cleansers or polish.**



**Dust and pick up spills using a clean, non-colored, lint-free cloth.**



**Stains may be removed with mild soap solution and a damp cloth.**



**Do not place furniture under direct sunlight.**



**Do not place furniture near heating or cooling vents.**



**Do not write on furniture without a padded barrier to protect the surface.**



**Do not place furniture outside, for indoor use only.**