



HELLO

PX9019-03D Manual Reclining Sofa

Manufactured for Rooms To Go

SKU:

11190179

11190193



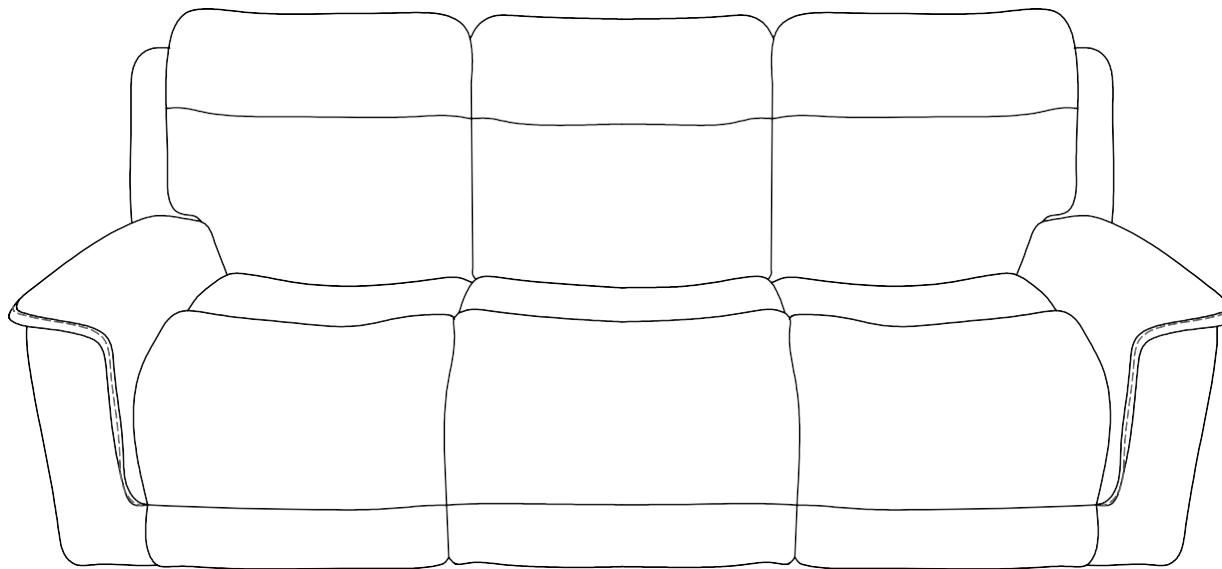



11190181

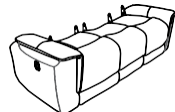

LIST OF PARTS

TOOL REQUIRED: NO TOOL REQUIRED

PART LIST

No.	Description	Item	Quantity
A	Seat		1
B	LAF Backrest		1
C	Middle Backrest w/DDT		1
D	RAF Backrest		1
E	LAF Wing		1
F	RAF Wing		1

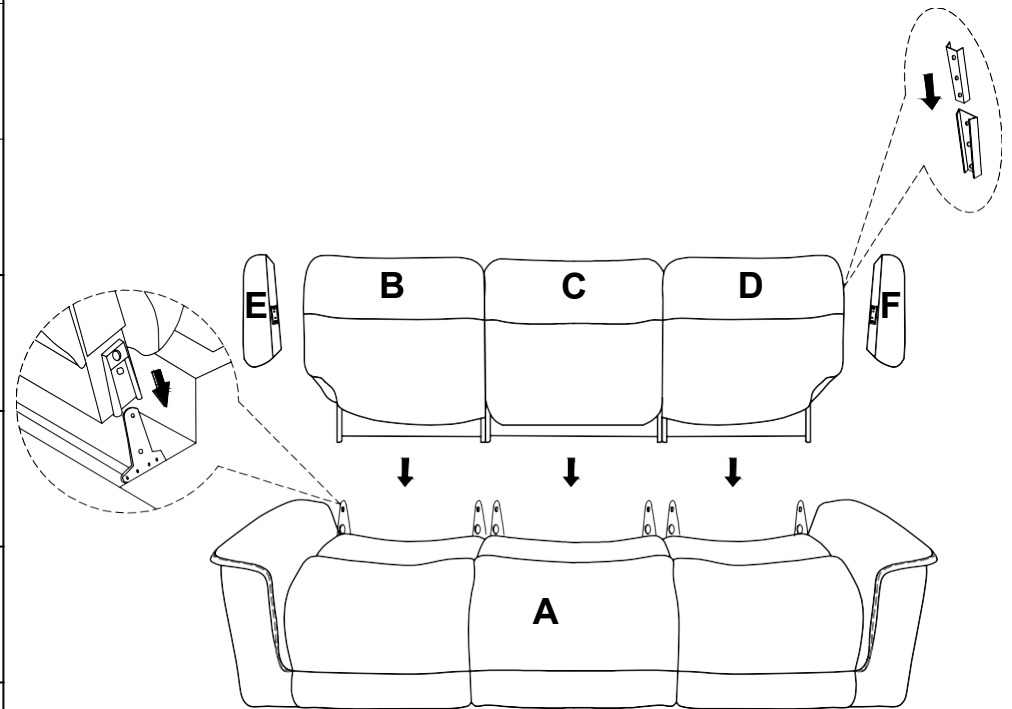

ASSEMBLY INSTRUCTION

Attention: The LAF Wing (E) & RAF Wing (F) have been packed and put into the arm frame bottom as picture shown below, take them out and set aside to be used later in Step 2.

STEP 1: Attaching the KD Backs (B, C & D)

Install the Middle Backrest (C) into the Seat (A) by positioning the female metal receiver brackets over the male metal posts. Ensure that female metal receiver brackets on each side of the backrest are positioned over the seat metal posts, push down the female brackets over the male posts simultaneously until each side is locked into place with an audible "click" is heard. Install the LAF Backrest & RAF Backrest (B & D) in the same way described above.

STEP 2: Attaching the KD Wings (E & F)

Insert the LAF Wing & RAF Wing (E & F) separately to the side of the LAF & RAF Backrest (B & D), make sure they are secured in position.

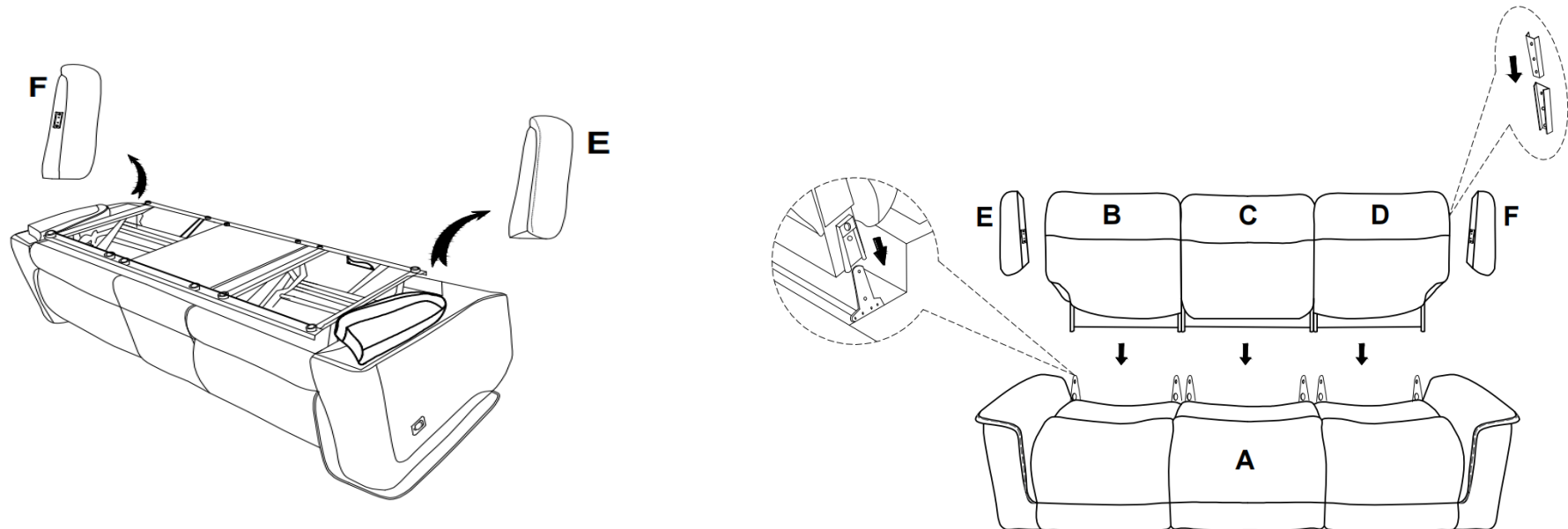

OPERATION

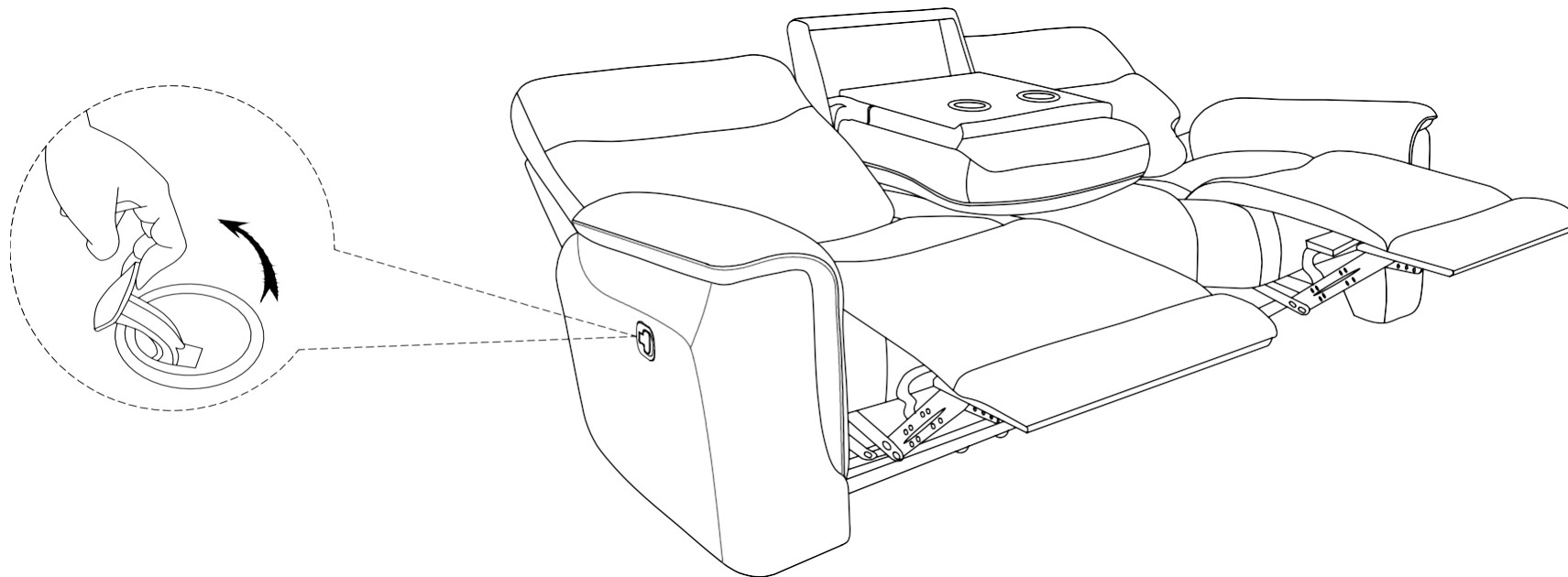

WARNINGS

*Keep unit at least 24" from all heat sources.

*Avoid placing unit in areas where unit can be exposed to direct sunlight other powerful light sources, as fading or discoloration may occur.

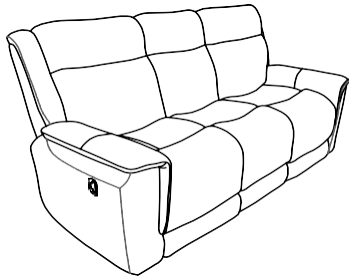

*Do not reach under seat when mechanism is operating or serious injury may occur.

*Reclining mechanism should only be operated while seated properly.

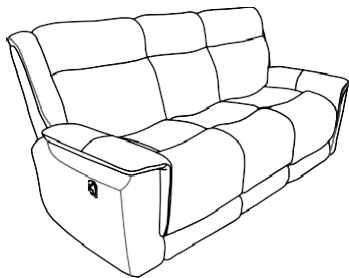

*Do not sit on arms or backrest.

*Do not jump or roughhouse on furniture.

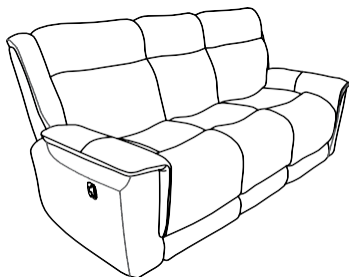

Maintain minimum of 6" space between the furniture backs and wall.

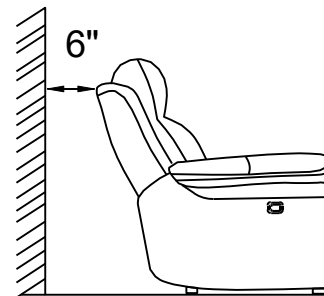

*If unit must be moved, do not drag. Unit must be lifted in order to be moved.

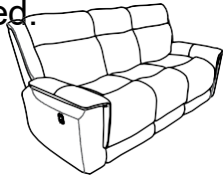

*Do not continuously operate mechanism for more than one minute or unit may go into protection mode by shutting down to prevent overheating.

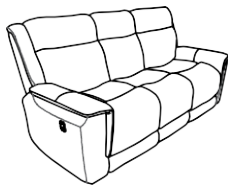

CARE AND CLEANING

*Upholstered furniture is packaged tightly to protect it during transit. This packaging can sometimes cause creases or misshaped cushions when the furniture comes out of the packaging. These issues will correct themselves over time as the fibers of the cushions are exposed to air. However, shaping the cushions with your hands can alleviate the creases and compressed fibers more quickly.

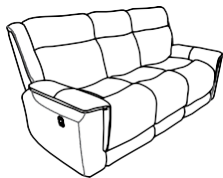

- *Dust often and use a vacuum cleaner to remove debris from seams and crevasses.
- *Use a soft damp cloth to gently clean soiled areas and wipe clean. Do not rub.
- *Do not use household cleaners or solvents. Such cleaners may cause damage and/or discoloration.
- *Do regularly use dedicated leather care product onto the leather furniture to prevent built up of body oils.

TROUBLESHOOTING

PROBLEM	SOLUTION
Backrests gaps	Ensure the backrest is properly clipped into the male posts located on seat mechanism (Step 1). Check that brackets are not loose, positioned improperly or bent.