





## Assembly Instructions

SYNE 2179-73PHR ZG Reclining Console Loveseat w/Pwr headrest

SKU# 11221734 11221746 11221758

**\*\*\*CAUTION:** The item is heavy, assembly should be performed by two people.

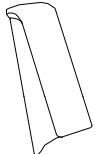
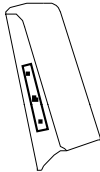
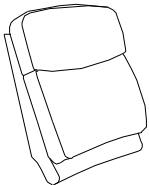
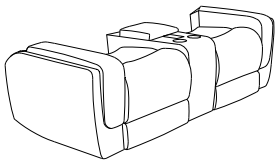
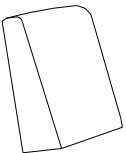
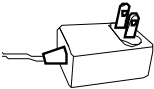
### Parts and Hardware List

No	Description	Image	Qty	No	Description	Image	Qty
A	LSF Wing		1	E	RSF Wing		1
B	LSF Back Cushion		1	F	Loveseat console Recliner Base		1
C	Console Back Cushion		1	G	Transformer		1
D	RSF Back Cushion		1				

**Step 1**  
Slide the metal receiver over the metal post. Press both sides of back firmly downward until locked in place.

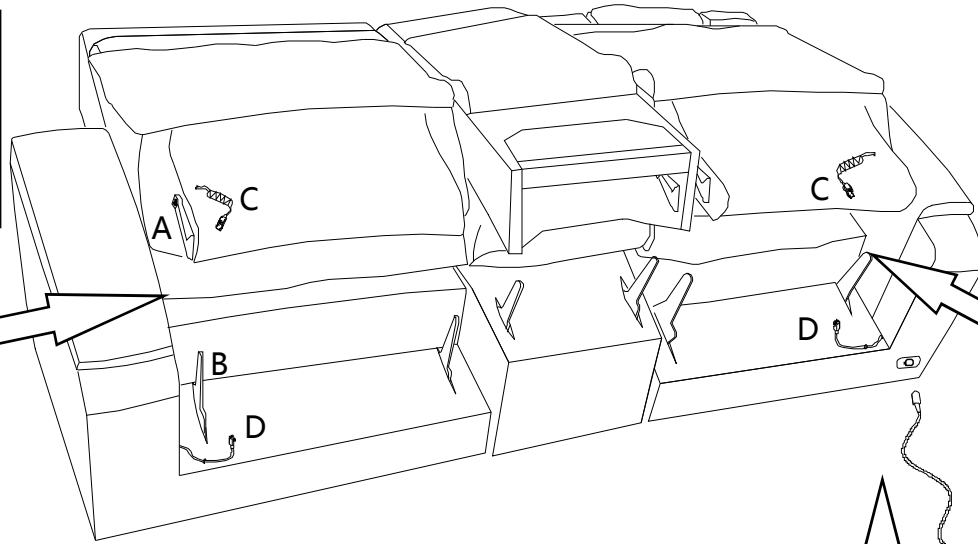
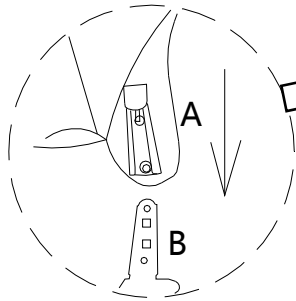

**Step 2**  
Locate the power cord C attached to the bottom back and connect to plug D located at the rear of seat.

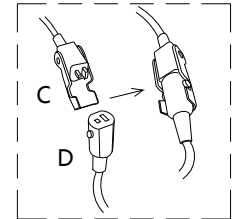

**Step 3**  
Insert the male KD Bracket into the slot of the female Bracket pressing firmly downward until the frame is tight.

**Step 4**  
The Transformer is attached to the bottom of rail and connect to DC Port located at the rear of arm.

**Note:** Make sure all PLUGS are connected on the product before plugging power cord into power outlet. If not damage can occur. The USB ports (where applicable) are designed with working voltage of 5V, and can NOT be used to supply power for laptop computers (neither PC or Mac). Plugging a laptop computer to the USB port may end up damaging either the computer or the USB port due to unmatched working voltage.

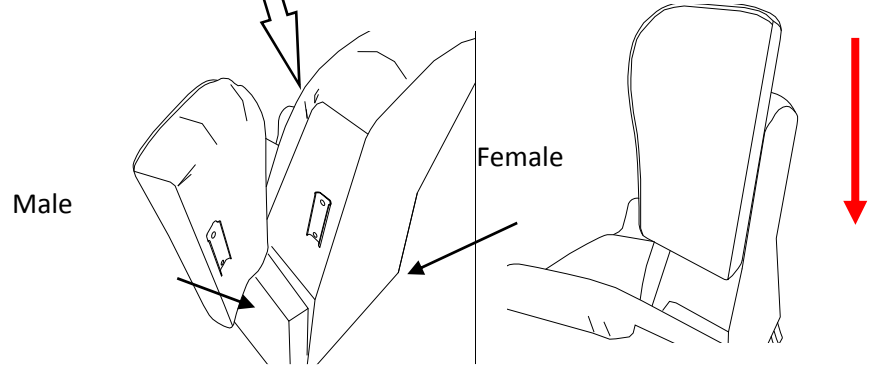

## Function introduction for JLDK.67.05.01/JLDK.67.05.02

### A. Functions:

LSF JLDK.67.05.01

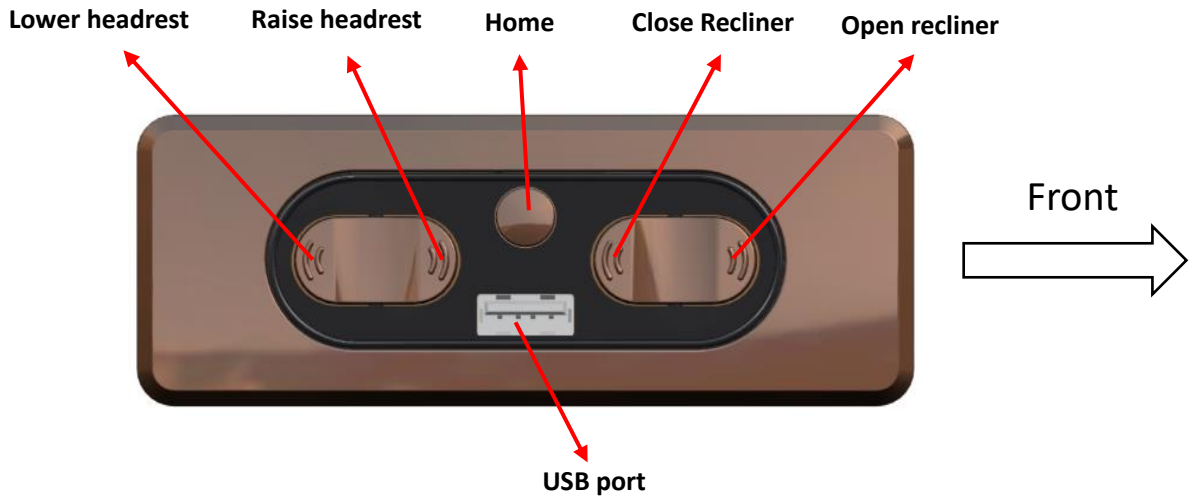

RSF JLDK.67.05.02

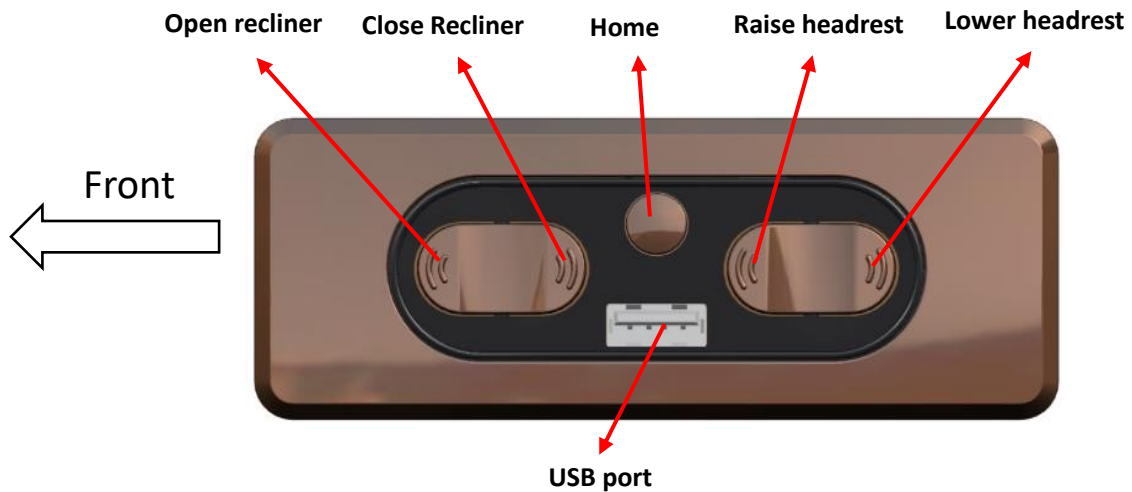

### C.USB charging ports:

- 1) USB ports are for charging mobile devices ONLY (not compatible with computers).
- 2) Output 5V 2A.
- 3) **DO NOT USE USB SPLITTER/EXTENDERS, DO NOT CHARGE MULTIPLE DEVICES AT ONE TIME, OTHERWISE DAMAGES COULD OCCUR.**