

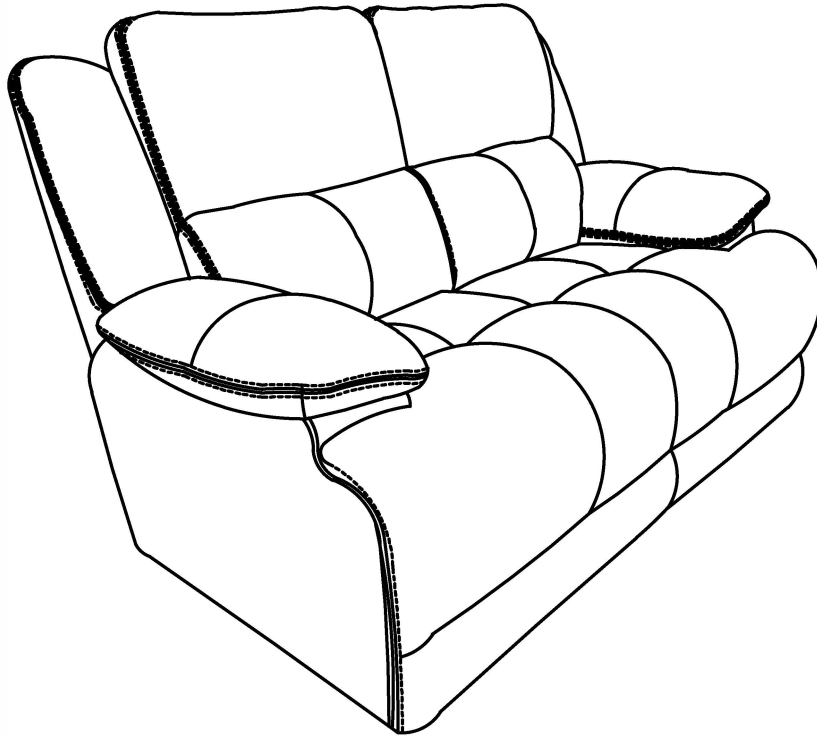









# ASSEMBLY INSTRUCTIONS

BCHN:L00803200/L00802200/L00804200 LOVESEAT STATIONARY  
 SKU:15310080/11310098/11310086



**TOOLS REQUIRED: NO TOOLS REQUIRED**

**PARTLIST**

| NO | Description       | Sketch  | Quantity |
|----|-------------------|---|----------|
| A  | SEAT              |  | 1        |
| B  | BACKREST          |  | 1        |
| C  | LEFT WING         |  | 1        |
| D  | RIGHT WING        |  | 1        |
| E  | RIGHT TOP ARM PAD |  | 1        |
| F  | LEFT TOP ARM PAD  |  | 1        |
| G  | THREADED BOLTS    |  | 4        |
| H  | NUTS              |  | 4        |
| I  | PLASTIC LEG       |  | 4        |

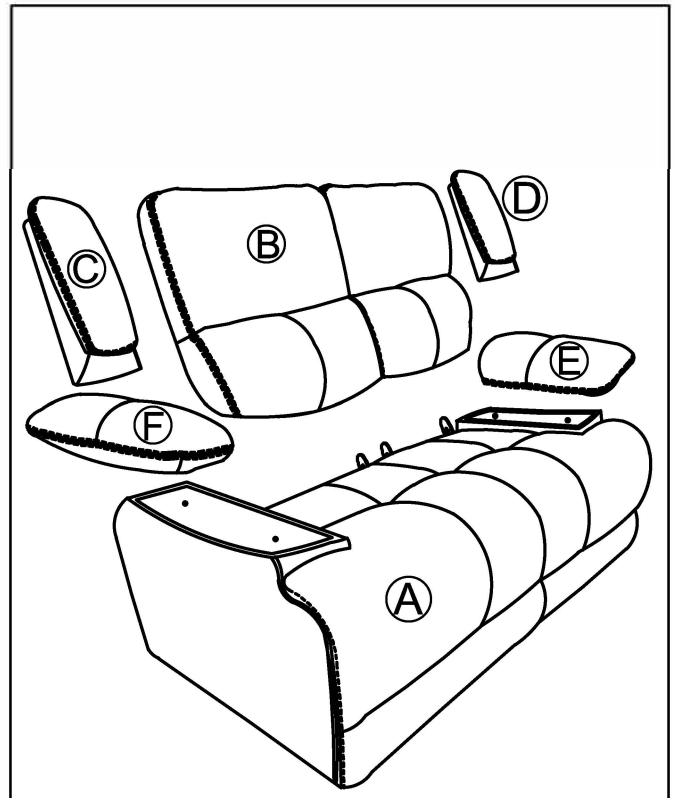

This product is manufactured by (GLORY OCEANIC ) for **ROOMS TO GO**

# ASSEMBLY INSTRUCTIONS

BCHN:L00803200/L00802200/L00804200 LOVESEAT STATIONARY SKU:15310080/11310062/11310086

**Step 1 :** The top arm pads can be found packaged inside of the arm frame. Locate the threaded bolts nuts(G) attached to the rear of the Seat.

\* Threading bolt nut(H) with arm pad(F/E) then tighten to securely hold the arm pad in place.  
Be careful not to over tighten

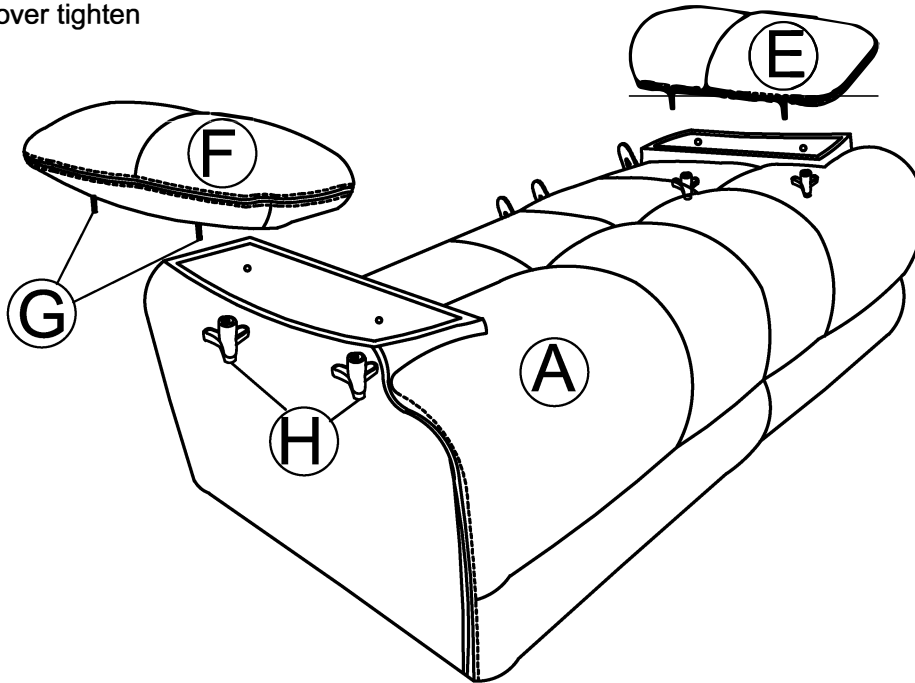

**Step 2 :** Legs are needed to properly support the frame and to distribute weight evenly. Four plastic legs are supplied for the loveseat.

\* Tighten the legs completely into the threaded inserts of the frame

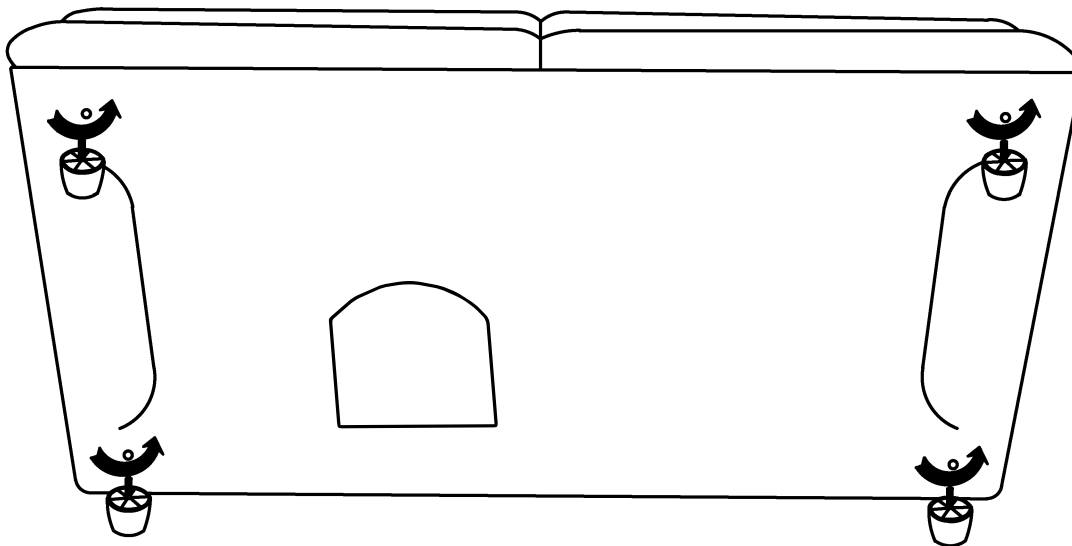

This product is manufactured by (GLORY OCEANIC ) for **ROOMS TO GO** ▶

# ASSEMBLY INSTRUCTIONS

BCHN:L00803200/L00802200/L00804200 LOVESEAT STATIONARY SKU:15310080/11310062/11310086

**Step 2** : position the back (A) with clip on over the mechanism tab at rear of Body (B) as picture below. Ensure both clips on back are aligned with tabs, then press top of back frame downward until a clicking sound is heard, slide metal insert on the wing (C&D) into metal sleeve on back (B) until it is completely installed.

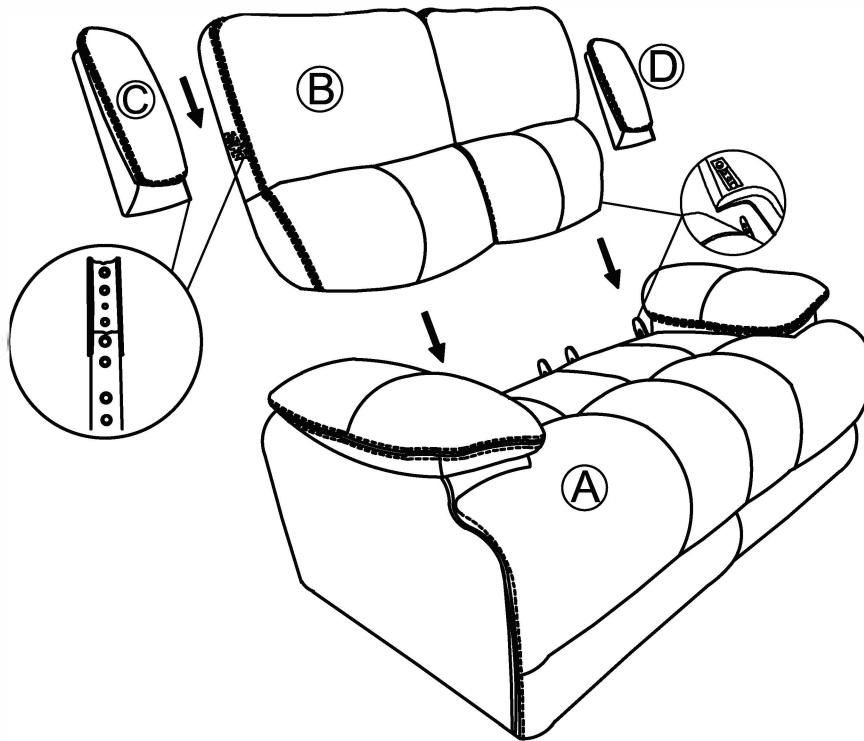

- Please keep the sofa at least 20" away from heat producers, such as heating equipment and radiator.
- Please avoid placing the sofa under strong sun or strong lamplight to remain its original color.
- Maintain minimum of 6" space between the furniture backs and wall.

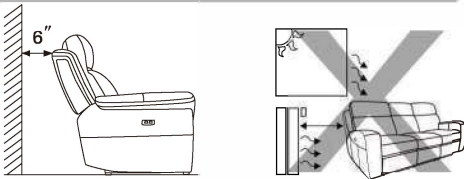

## Points For Attention

The frame inside your sofa will always remain intact and strong over time, providing you comply with the following recommendations:

- Avoid jumping on the sofa and do not throw yourself violently onto the sofa.
- Do not sit on the arms and/or the Back.
- Do not sit on the footrest when mechanism is open.

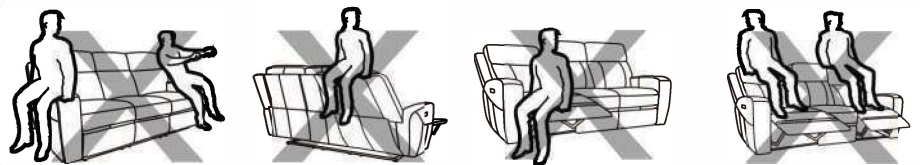

- Do not leave when the recliner is not fully closed.
- Please do not use solvents to clean the mental parts of the mechanism: a damp cloth is sufficient.
- Please do not allow children to play with the Mechanism.
- Please use the mechanism only when the person seats himself properly instead of sideways or forwards.
- Do not touch the mechanical parts.
- Please do not continuously use the electric motor that control the reclining function of on-and-off over one minute. This action could cause the motor to cut-off due to overheating. Allow the system to cool down for 5 minutes to restore the motor to correct working order.
- Please remove the plug before cleaning the mechanism or performing other operations on it.
- Please do not drag sofa on rough or smooth surface. If the sofa needs to be moved, it must be lifted up but not pushed.



This product is manufactured by (GLORY OCEANIC ) for **ROOMS TO GO** ▶

# ASSEMBLY INSTRUCTIONS

BCHN:L00803200/L00802200/L00804200 LOVESEAT STATIONARY SKU:15310080/11310062/11310086

- The sofa requires no special but normal maintenance, so does the padding material.
- If your sofa is with fabric filler or down feather padding, you will need to shape its cushions carefully to make them restore to their original shapes, because long way transportation will make the cushions out of shape.
- In fact, the long journey which the sofa is subjected to before reaching your home could temporarily affect the sofa's initial beauty.



Before shaping



After shaping



## Care and Cleaning

Dust often and use a vacuum cleaner to clean seams. To maintain the fabric appearance, gently clean soiled areas with soft cloth dampened with water. Wipe with a clean, damp surface (do not rub).

**Spot Cleaning Fabric:** Blot any spills immediately; do not rub. Blot away the excess liquid with a clean, dry, white cloth; turning the cloth frequently.

**Do not** use common household cleaners, solvents, or dry cleaning fluids on fabric furniture. These cleaners may cause damage and color fading.

**Do not** use or place sharp objects on upholstered furniture.

**Do not** place furniture in direct sunlight and keep furniture at least 60cm/2 ft from heat sources to avoid fading.



| PROBLEM          | SOLUTION  |
|------------------|---|
| No power         | Check all power connections (Step 6,7,8,9,10,11)                                |
| No Reclining     | Check all power connections (Step 6,7,8,9,10,11)                                |
| USB Not Charging | Check all power connections (Step 8,9,10,11) verify that USB cable functioning  |
| Backrest Uneven  | Ensure that seatback brackets are installed and locked in position (Step 2,3,4) |

This product is manufactured by (GLORY OCEANIC) for **ROOMS TO GO**