

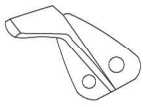



LIST OF PARTS

TOOLS REQUESTED: Customer should find a screwdriver to install the screw

PART LIST

NO	Description	Item	Quantity
A	Metal leg		4
B	M10 screw	0.4"*37*2.4" 	8
C	washer	0.4"*Φ18*2mmT 	8
D	Plastic leg		2
E	wall plug transformer		1

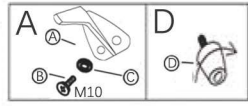
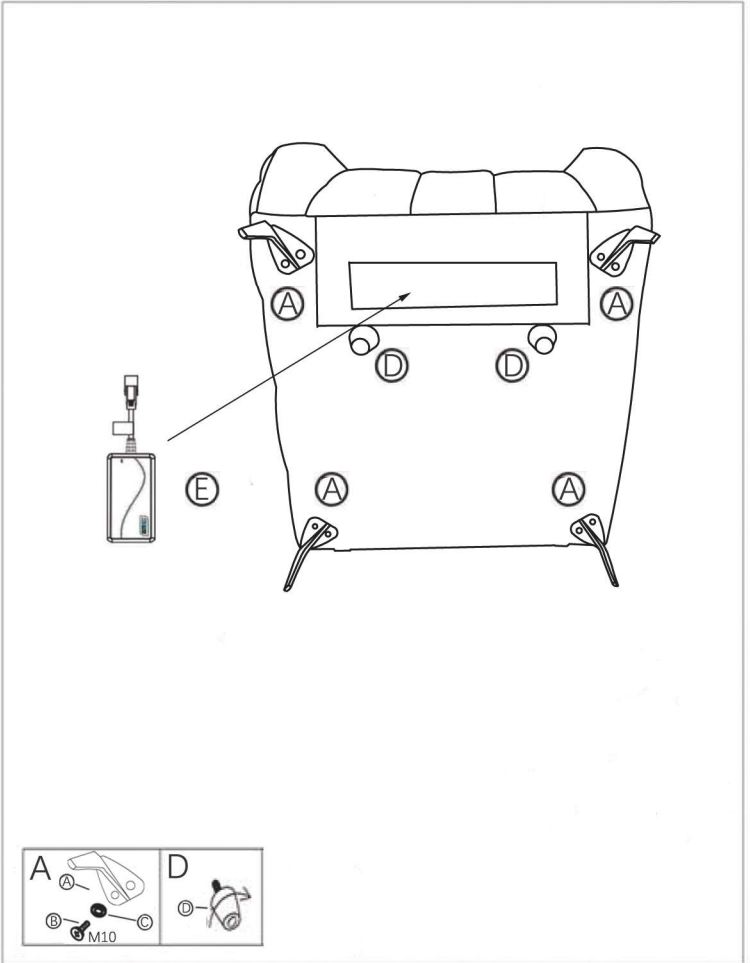

ASSEMBLY INSTRUCTIONS

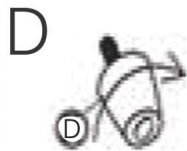
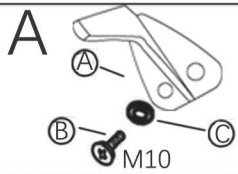

STEP 1:

Please put the chair upside down, find the chair legs on the bottom of chair.

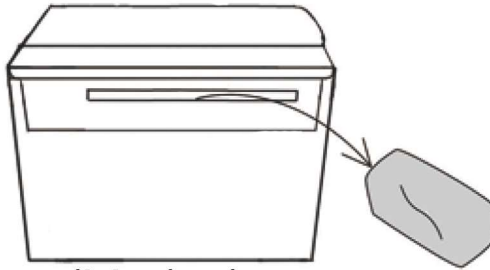

(Motion)

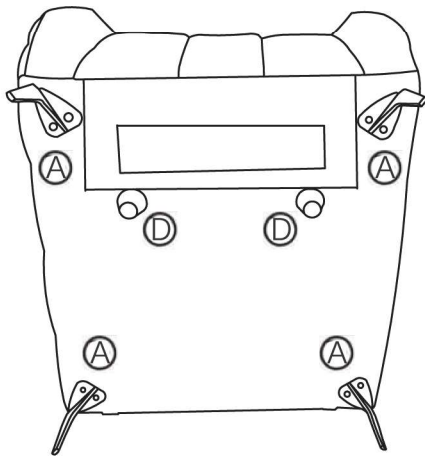

Install all legs accordingly to above instruction:

1)Front & Back leg: Attach the metal leg (A) into the bottom of produce by using 1 piece washer (C) and M10 screw (B) through the hole. Use screwdriver to tighten the M10 screws(B) clockwise until secure.

2)Central leg: Insert the plastic leg (D) in to the hole. Use hand to tighten the plastic leg (D) clockwise until secure.

STEP 2:

POWER CONNECTIONS

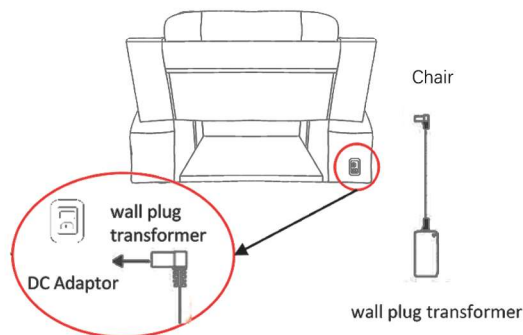

STEP 3:

POWER CONNECTIONS

Connect wall plug transformer from Left Arm Seat to outlet.

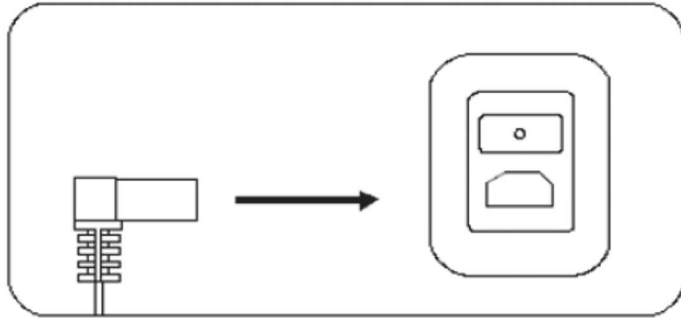

Connect wall plug transformer from Left Arm Seat to outlet.
wall plug transformer to Electrical Outlet

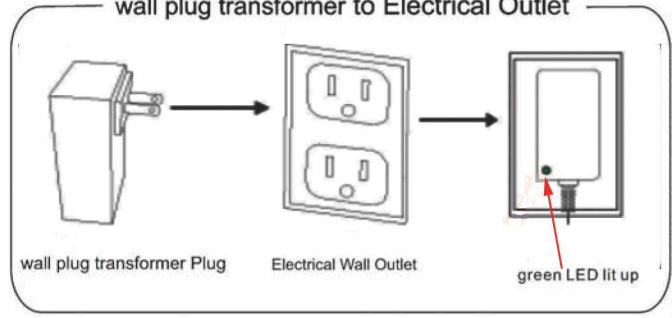

⚠ WARNING

Misuse can result in FIRE or DEATH by ELECTRICAL SHOCK

29 VDC/ 2.0A
Changzhou Kaide Electrical Inc.
KDDY008M

Read all instructions before using this furnishing.

DANGER – To reduce the risk of electric shock:

- Always unplug this furnishing from the electrical outlet before cleaning or servicing.

WARNING – To reduce the risk of burns, fire, electric shock, or injury to persons:

- Unplug from outlet before putting on or taking off parts.
- Never operate this furnishing if it has a damaged electrical cord or plug, if it is not working properly, or if the electrical cord or plug has been damaged or dropped into water. Stop using this furnishing and call a service center for examination and repair.
- Keep the electrical cord and plug away from heated surfaces and other heat sources.
- To disconnect, turn all controls to the off position, then remove plug from outlet.
- When operating, ensure that electrical cord is not under the base, legs, or motion mechanism to avoid damage to electrical cord or plug.
- Do not strain or stretch electrical cord.
- Do not use extension cords or power strips.
- Keep out of reach of children. This is not a toy.
- Plug directly into a compatible electrical socket.
- Do not modify the plug or use any adapters.

⚠ WARNING

El mal uso puede provocar INCENDIO o MUERTE por DESCARGA ELÉCTRICA

29 VDC/ 2.0A
Changzhou Kaide Electrical Inc.
KDDY008M

Leer todas las instrucciones antes de usar este mobiliario.

PELIGRO – Para reducir el riesgo de descarga eléctrica:

- Siempre desenchufe este accesorio de la toma de corriente eléctrica antes de limpiarlo o repararlo.

ADVERTENCIA: para reducir el riesgo de quemaduras, incendios, descargas eléctricas o lesiones a personas:

- Desenchufe del tomacorriente antes de colocar o quitar partes.
- Nunca opere este accesorio si tiene un cable o enchufe eléctrico dañado, si no funciona correctamente, o si el cable o el enchufe eléctrico se ha dañado o se ha caído al agua. Deje de usar este equipamiento y llame a un centro de servicio para que lo examinen y lo reparen.
- Mantenga el cable eléctrico y el enchufe lejos de superficies calientes y otras fuentes de calor.
- Para desconectar, gire todos los controles a la posición de apagado, luego retire el enchufe del tomacorriente.
- Al operar, asegúrese de que el cable eléctrico no esté debajo de la base, las patas o el mecanismo de movimiento para evitar dañar el cable eléctrico o el enchufe.
- No fuerce ni estire el cable eléctrico.
- No utilice cables de extensión o tomas de corriente.
- Mantener fuera del alcance de los niños. Esto no es un juguete.
- Enchúfelo directamente a una toma de corriente compatible.
- No modifique el enchufe ni utilice adaptadores.

STEP 4:

ELECTRICAL CONTROLS

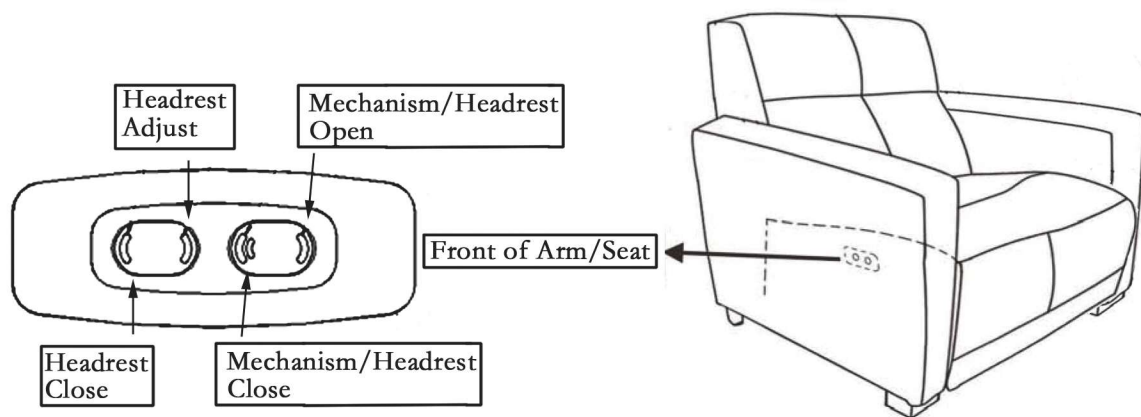

- Mechanism / Headrest Open :** Both the reclining mechanism and headrest will open simultaneously
- Mechanism / Headrest Close :** Will close both the reclining mechanism and headrest simultaneously
- Headrest Adjust :** Allows you to adjust the headrest only to your desired position independently from the reclining function
- Headrest Close :** Allows you to close the headrest at anytime regardless of the reclined position

WARNINGS

*Keep unit at least 24" from all heat sources.

*Avoid placing unit in areas where unit can be exposed to direct sunlight other powerful light sources, as fading or discoloration may occur.

Maintain minimum of 6" space between the furniture backs and wall.

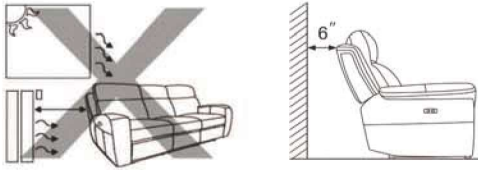

*Do not reach under seat when mechanism is operating or serious injury may occur.

*Reclining mechanism should only be operated while seated properly.



*Do not sit on arms or backrest.

*Do not jump or roughhouse on furniture.

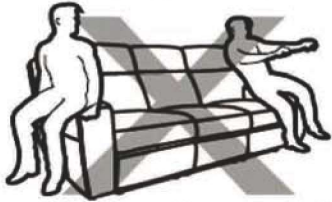

*If unit must be moved, do not drag. Unit must be lifted in order to be moved.

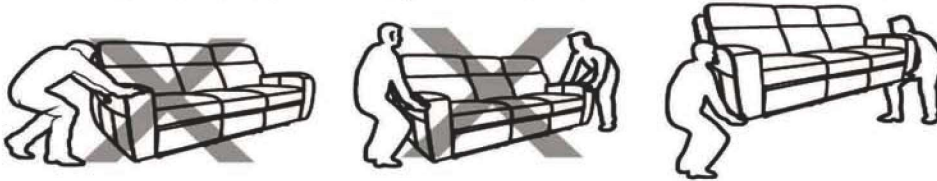

*Do not continuously operate mechanism for more than one minute or unit may go into protection mode by shutting down to prevent overheating.

*Unplug unit from power source prior to cleaning mechanism.

*Do not allow electrical components to come into contact with any liquids.

CARE AND CLEANING

*Upholstered furniture is packaged tightly to protect it during transit. This packaging can sometimes cause creases or misshaped cushions when the furniture comes out of the packaging. These issues will correct themselves over time as the fibers of the cushions are exposed to air. However, shaping the cushions with your hands can alleviate the creases and compressed fibers more quickly.



Before shaping

After shaping

*Dust often and use a vacuum cleaner to remove debris from seams and crevasses.

*Use a soft damp cloth to gently clean soiled areas and wipe clean. Do not rub.

*Do not use household cleaners or solvents. Such cleaners may cause damage and/or discoloration.

*Do regularly use dedicated leather care product onto the leather furniture to prevent built up of body oils.

TROUBLE SHOOTING

PROBLEM

SOLUTION

Not Reclining

Ensure that wall power outlet is operational Step 2,3,4