

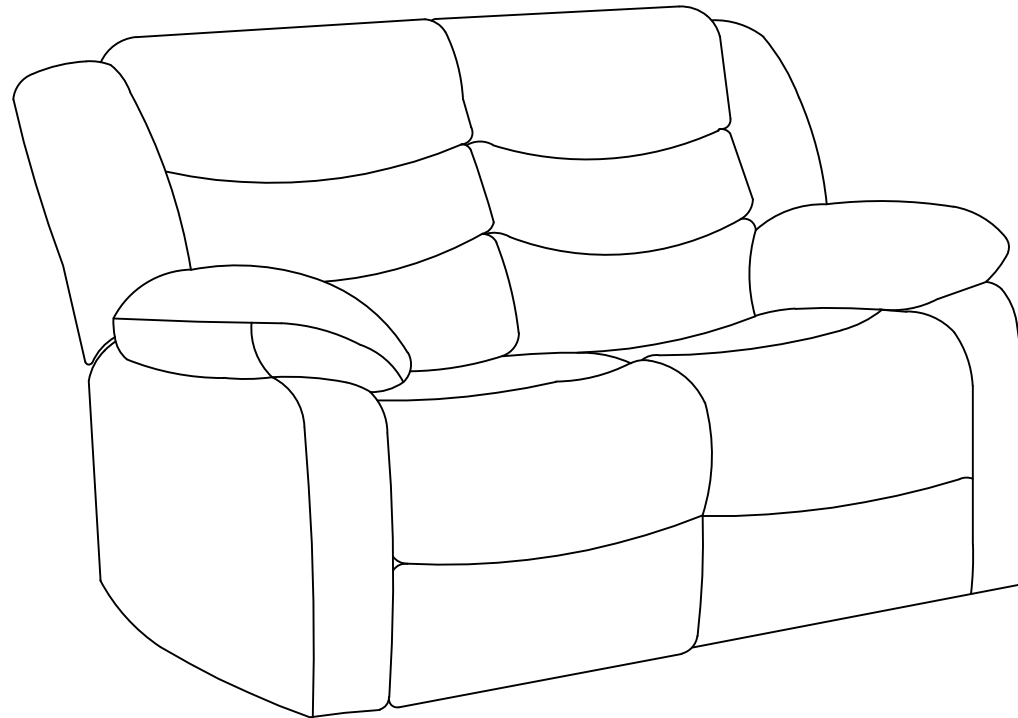

Manufactured for Rooms To Go

MNRM  
417000 Stationary Loveseat







SKU :  
11441704  
11441716  
11441728  
11441730

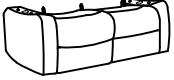

# LIST OF PARTS

**TOOLS REQUIRED:NO TOOLS REQUIRED**

## PART LIST

NO	Description	Item	Quantity
A	Seat		1
B	Left Backrest		1
C	Right Backrest		1
D	Left Armrest		1
E	Right Armrest		1
F	Fixed latch		4
G	Bun Foot		4

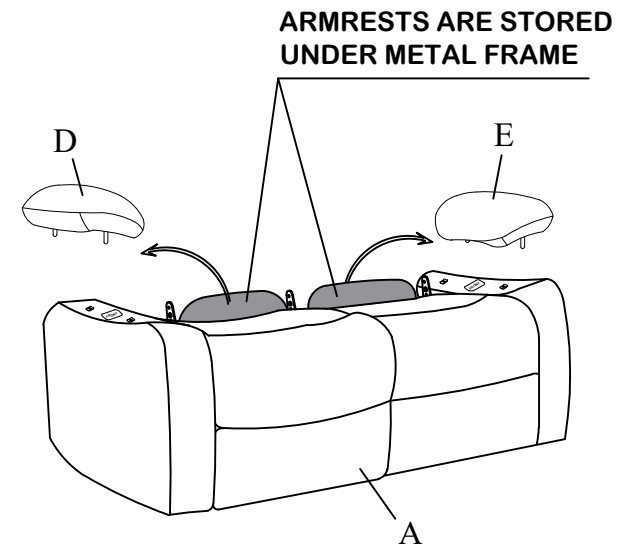
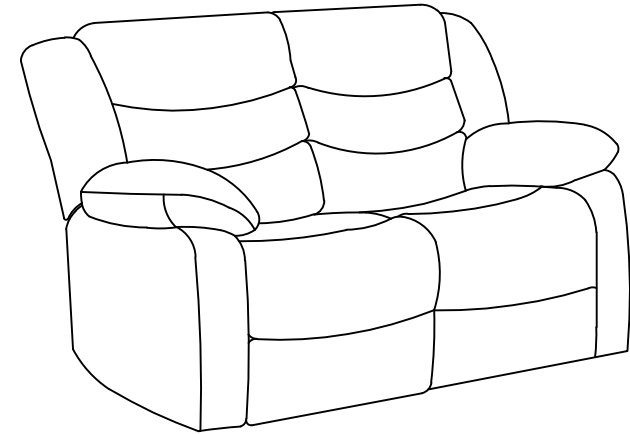

# ASSEMBLY

## STEP : 1

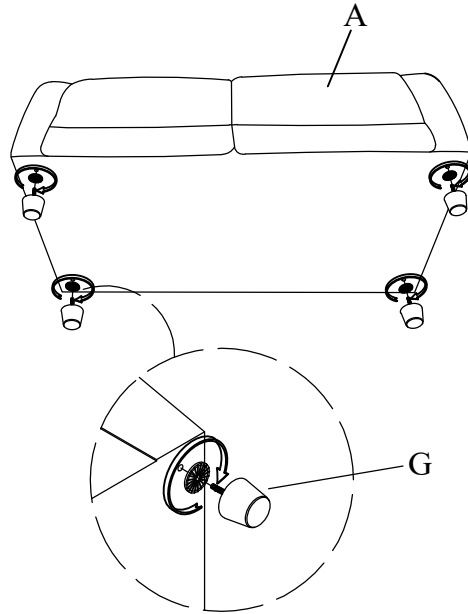

Attach the Bun foot (G) to the Seat (A)

## STEP : 2

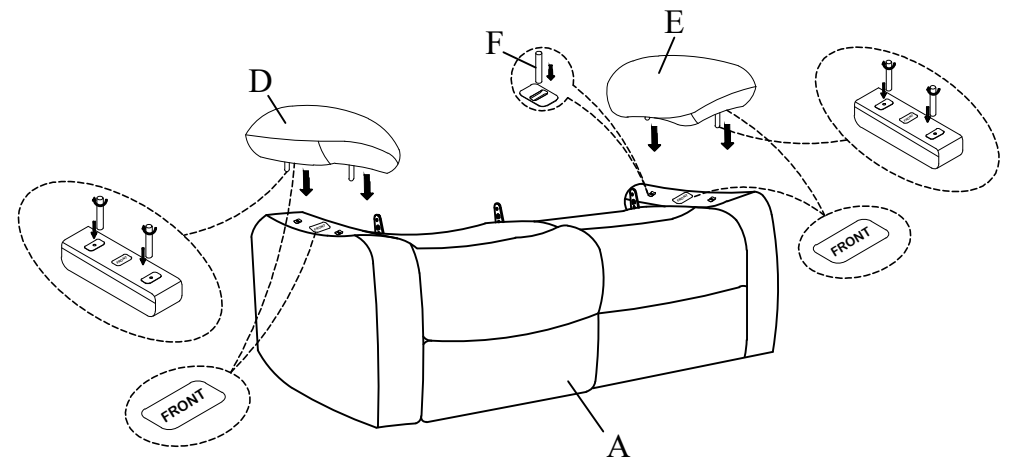

Attach the Left/Right Armrest (D/E) to the Seat (A) by using the Fixed latch (F).

# ASSEMBLY

## STEP : 3

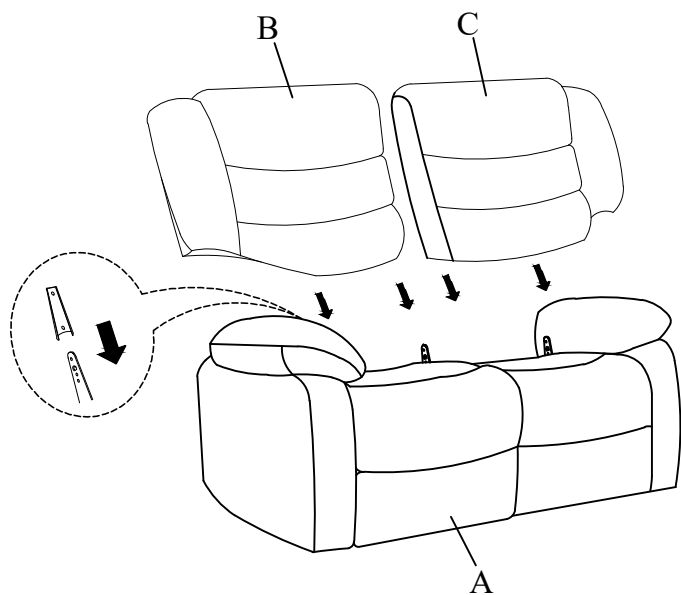

Attach the Backrest (B/C) to the Seat (A).

## STEP : 4

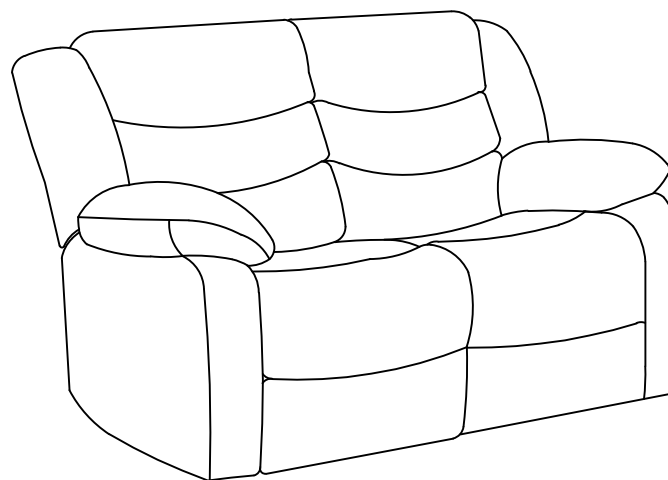

# WARNINGS

\*Keep unit at least 24" from all heat sources.

\*Avoid placing unit in areas where unit can be exposed to direct sunlight other powerful light sources, as fading or discoloration may occur.

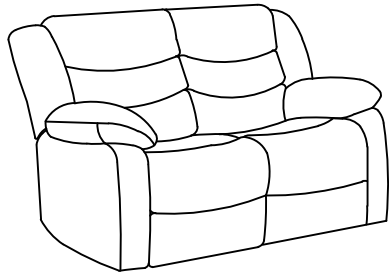

\*Do not reach under seat when mechanism is operating or serious injury may occur.

\*Reclining mechanism should only be operated while seated properly.

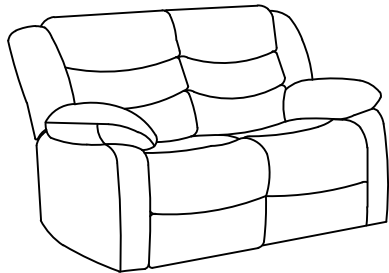

\*Do not sit on arms or backrest.

\*Do not jump or roughhouse on furniture

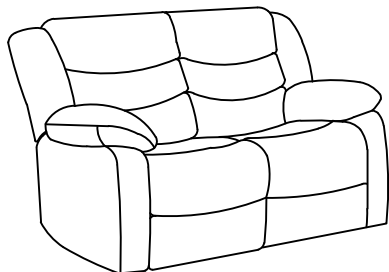

Maintain minimum of 6" space between the furniture backs and wall.

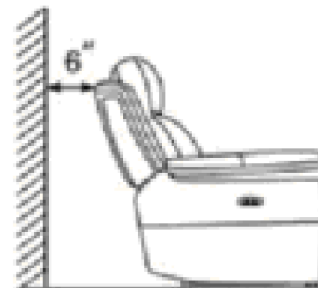

\*If unit must be moved. do not drag. Unit must be lifted in order to be moved

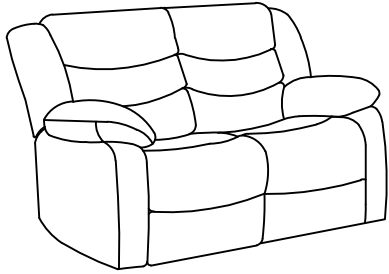

\*Do not continuously operate mechanism for more than one minute or unit may go into protection mode by shutting down to prevent overheating.

\*Unplug unit from power source prior to cleaning mechanism.

\*Do not allow electrical components to come into contact with any liquids.

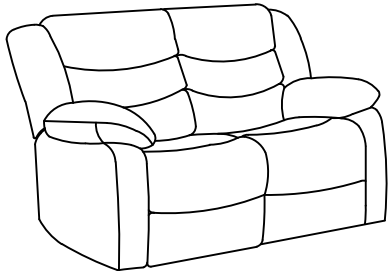

## CARE AND CLEANING

\*Unupholstered furniture is packaged tightly to protect it during transit. This packaging can sometimes cause creases or misshaped cushions when the furniture comes out of the packaging. These issues will correct themselves over time as the fibers of the cushions are exposed to air. However, shaping the cushions with your hands can alleviate the creases and compressed fibers more quickly.

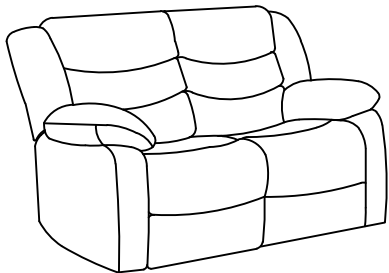

\*Dust often and use a vacuum cleaner to remove debris from seams and crevasses.

\*Use a soft damp cloth to gently clean soiled areas and wipe clean. Do not rub.

\*Do not use household cleaners or solvents. Such cleaners may cause damage and/or discoloration.

\*Do regularly use dedicated leather care product onto the leather furniture to prevent built up of body oils.

# TROUBLESHOOTING

PROBLEM	SOLUTION
Not Reclining	
USB not working	Check all the connections Step