

SHLI U81003-40B SKU: 11481013
(Canyon/Walnut/RedrockPiping)

U81003-40B SKU:11481025
(Canyon/Gray/Fog Piping)

Loveseat

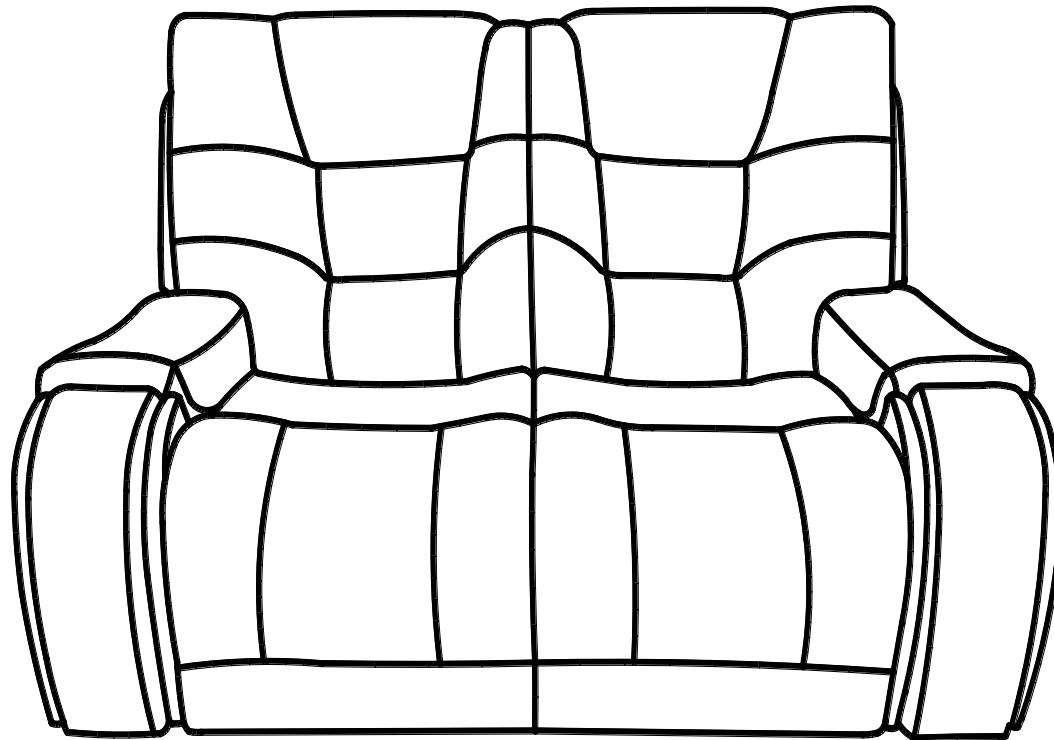





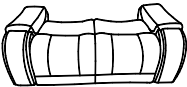

1

LIST OF PARTS

TOOLS REQUIRED: NO TOOLS REQUIRES

PART LIST

NO	Description	Item	Quantity
A	Seat		1
B	Left Backrest		1
C	Right Backrest		1
D	LSF KD Wing		1
E	RSF KD Wing		1
F	Plastic Leg		4

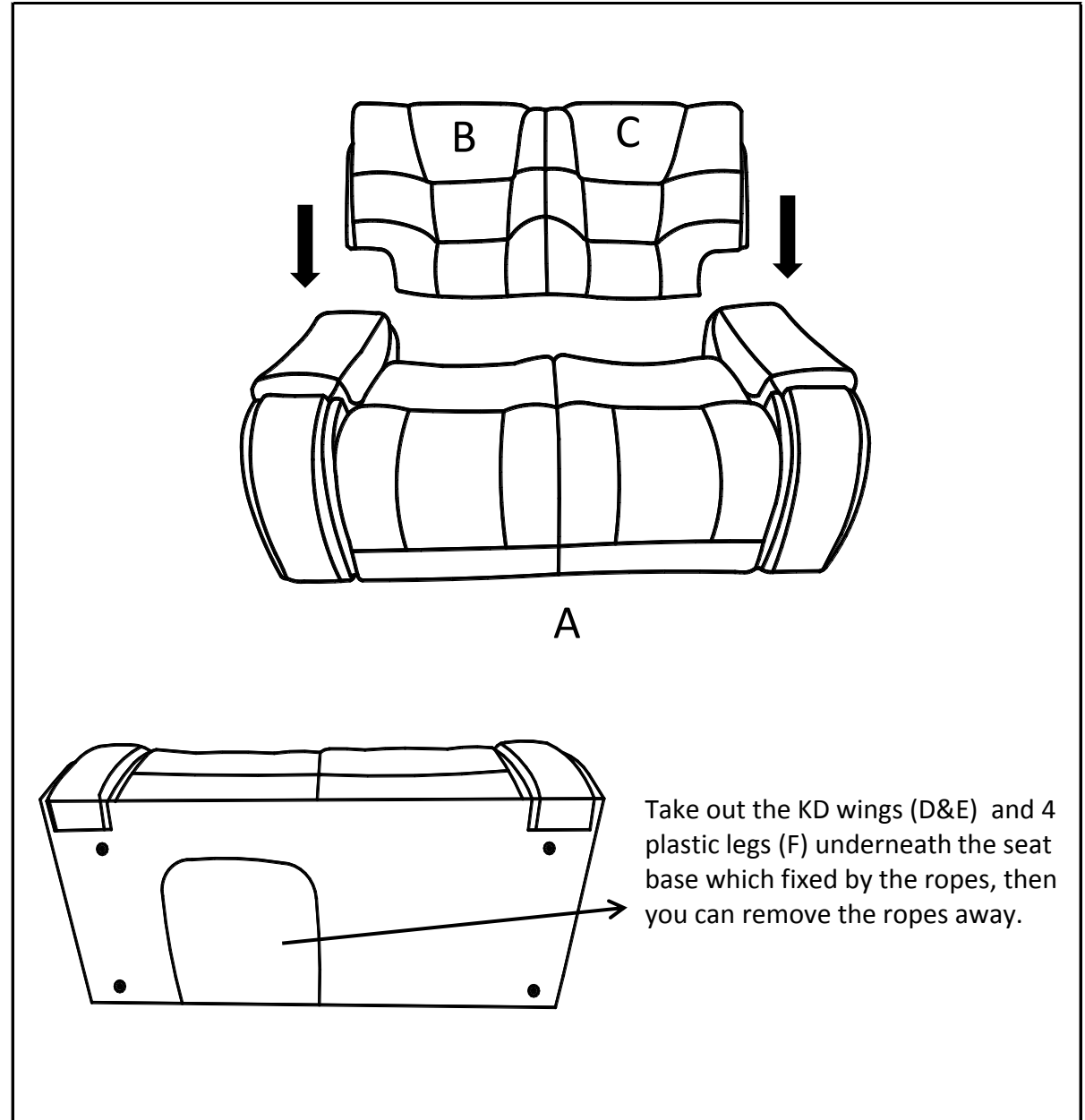

Take out the KD wings (D&E) and 4 plastic legs (F) underneath the seat base which fixed by the ropes, then you can remove the ropes away.

2

PART ASSEMBLY

STEP 1

Install the Backrest(B&C) into the Seat (A) by connecting the female receivers to the male connectors. Ensure that female receivers on each side of the backrest are connected to the seat male connectors.

KD Wing Assemble:

Hold the back KD wings and flap with both hands and line male and female brackets together (L matches L, R matches R). Apply downward force to top of back (one side at a time) to ensure snap engagement.

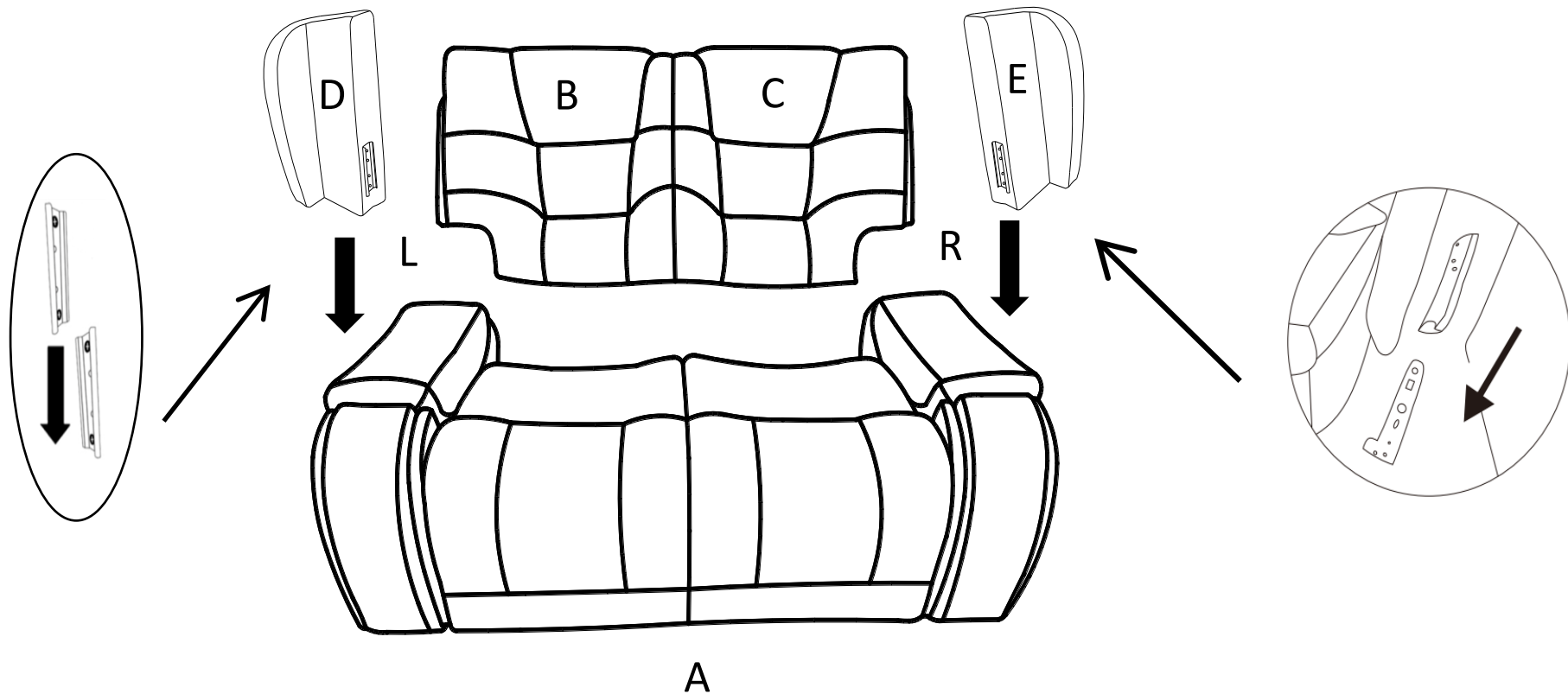

3

LEG ASSEMBLY

STEP 2
Legs are needed to properly support the frame and to distribute weight evenly. Four plastic legs are supplied for the loveseat.

Tighten the legs completely into the threaded inserts of the frame.

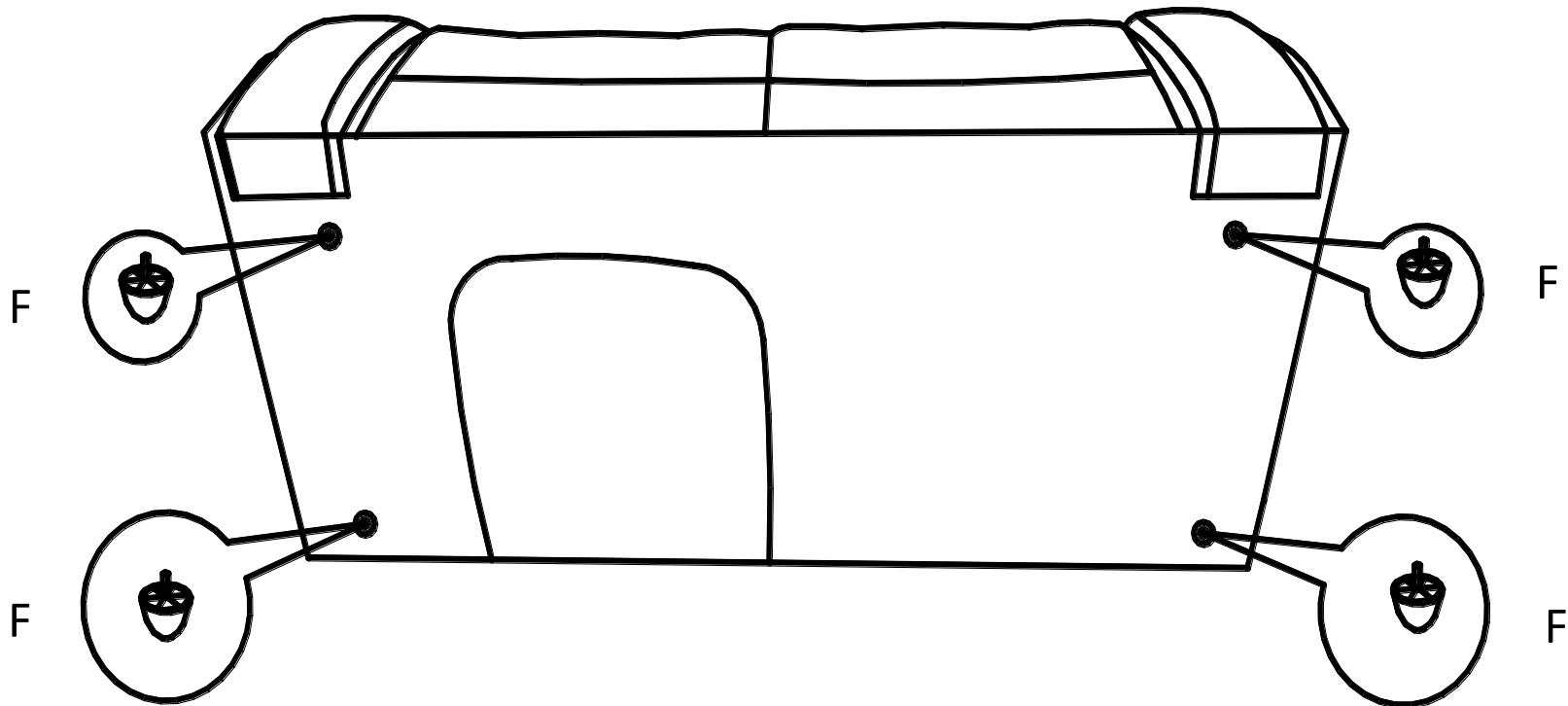

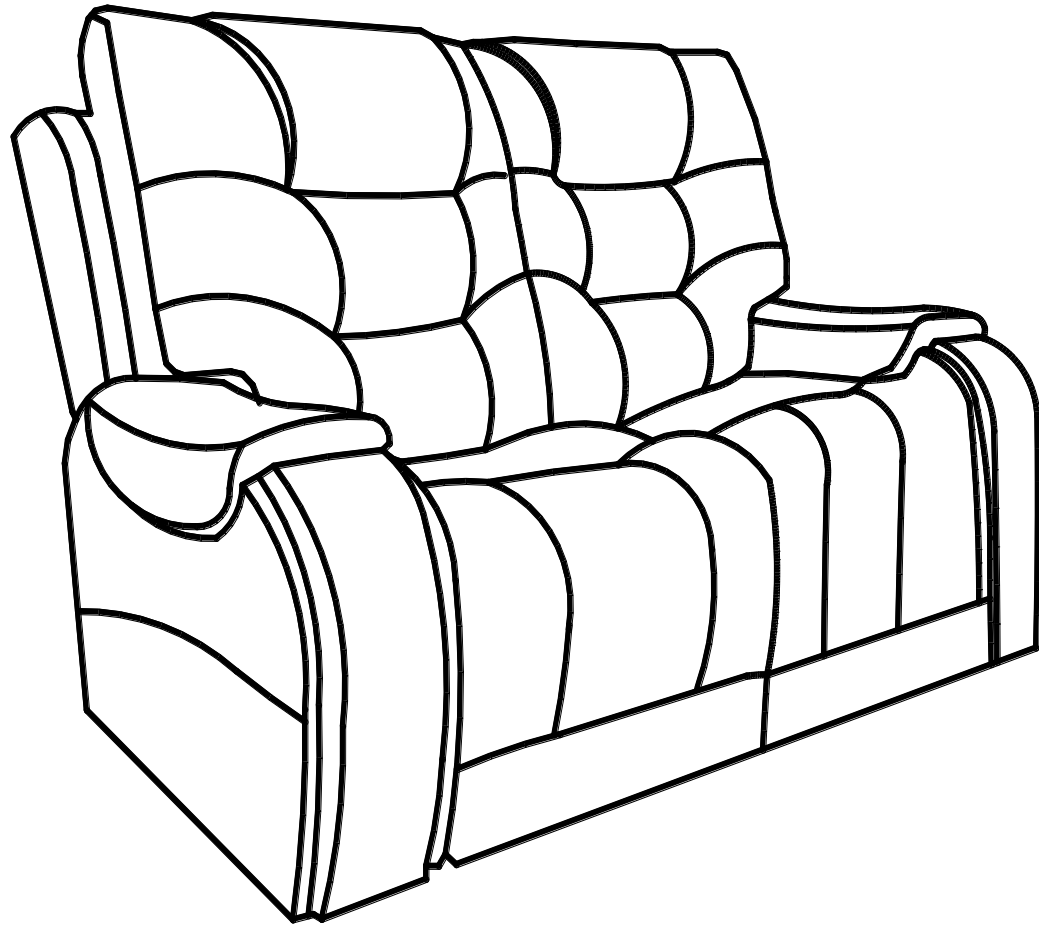

WARNINGS

*Keep unit at least 24" from all heat sources.

*Avoid placing unit in areas where unit can be exposed to direct sunlight or other powerful light sources, as fading or discoloration may occur.

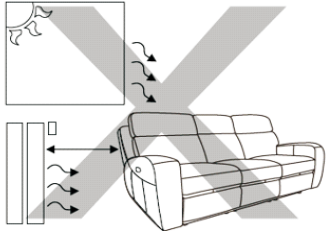

*Do not reach under seat when mechanism is operating or serious injury may occur.

*Reclining mechanism should only be operated while seated properly.

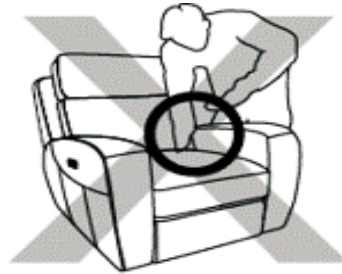

*Do not sit on arms or backrest.

*Do not jump or roughhouse on furniture.

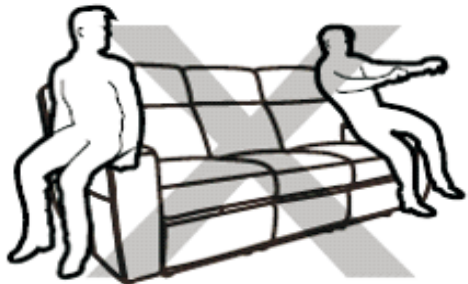

*Keep unit at least 5.5 inch from the wall.

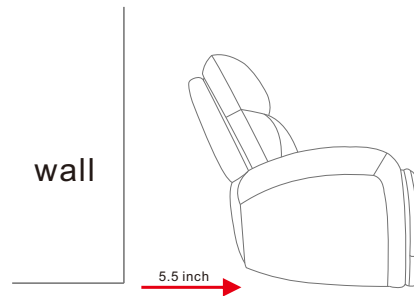

*If unit must be moved, do not drag. Unit must be lifted in order to be moved.



*Do not continuously operate mechanism for more than one minute or unit may go into protection mode by shutting down to prevent overheating.

*Unplug unit from power source prior to cleaning mechanism.

*Do not allow electrical components to come into contact with any liquids.

CARE AND CLEANING

*Upholstered furniture is packaged tightly to protect it during transit. This packaging can sometimes cause creases or misshaped cushions when the furniture comes out of the packaging. These issues will correct themselves over time as the fibers of the cushions are exposed to air. However, shaping the cushions with your hands can alleviate the creases and compressed fibers more quickly.



Before shaping



After shaping



*Dust often and use a vacuum cleaner to remove debris from seams and crevasses.

*Use a soft damp cloth to gently clean soiled areas and wipe clean. Do not rub.

*Do not use household cleaners or solvents. Such cleaners may cause damage and/or discoloration.

*Do regularly use dedicated leather care product onto the leather furniture to prevent built up of body oils. 49900946