

Manufacture Name: KTCL JASONFURNITURE VIET NAMCOMPANY LIMITED



Manufactured for Rooms To Go

KTCL KMR.6631

SKU : 11566316、11566328、11566330

GLIDER RECLINER

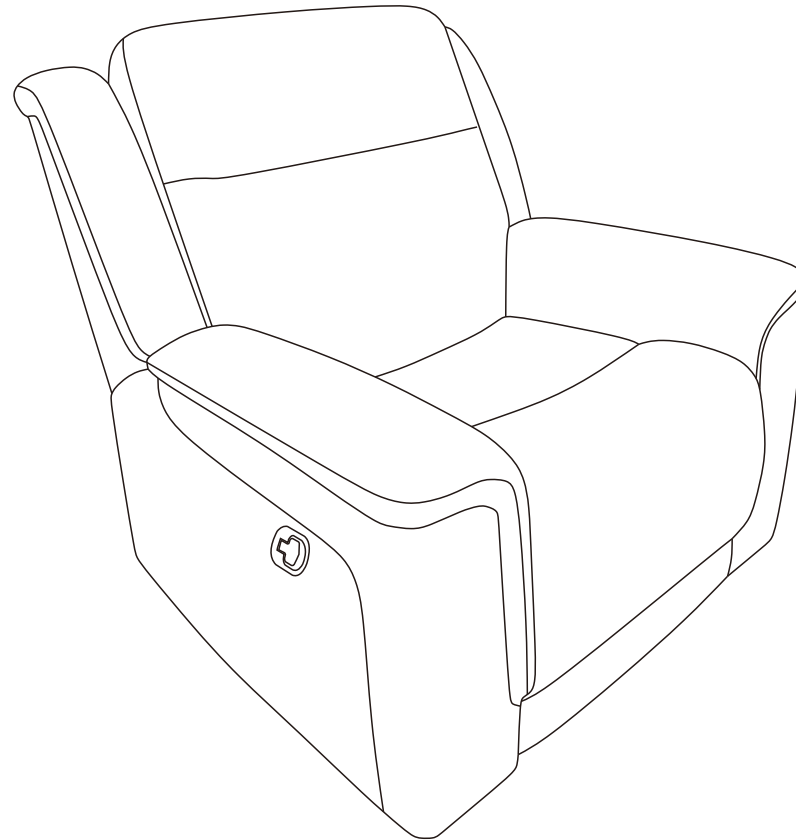

1双手动带摆



# List of Parts

TOOLS REQUIRED:NO TOOLS REQUIRED

## PART LIST

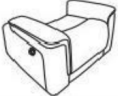
NO	Sketch	Description	Quantity
A		Wing(L)	1
B		Wing(R )	1
C		Back	1
D		Body	1

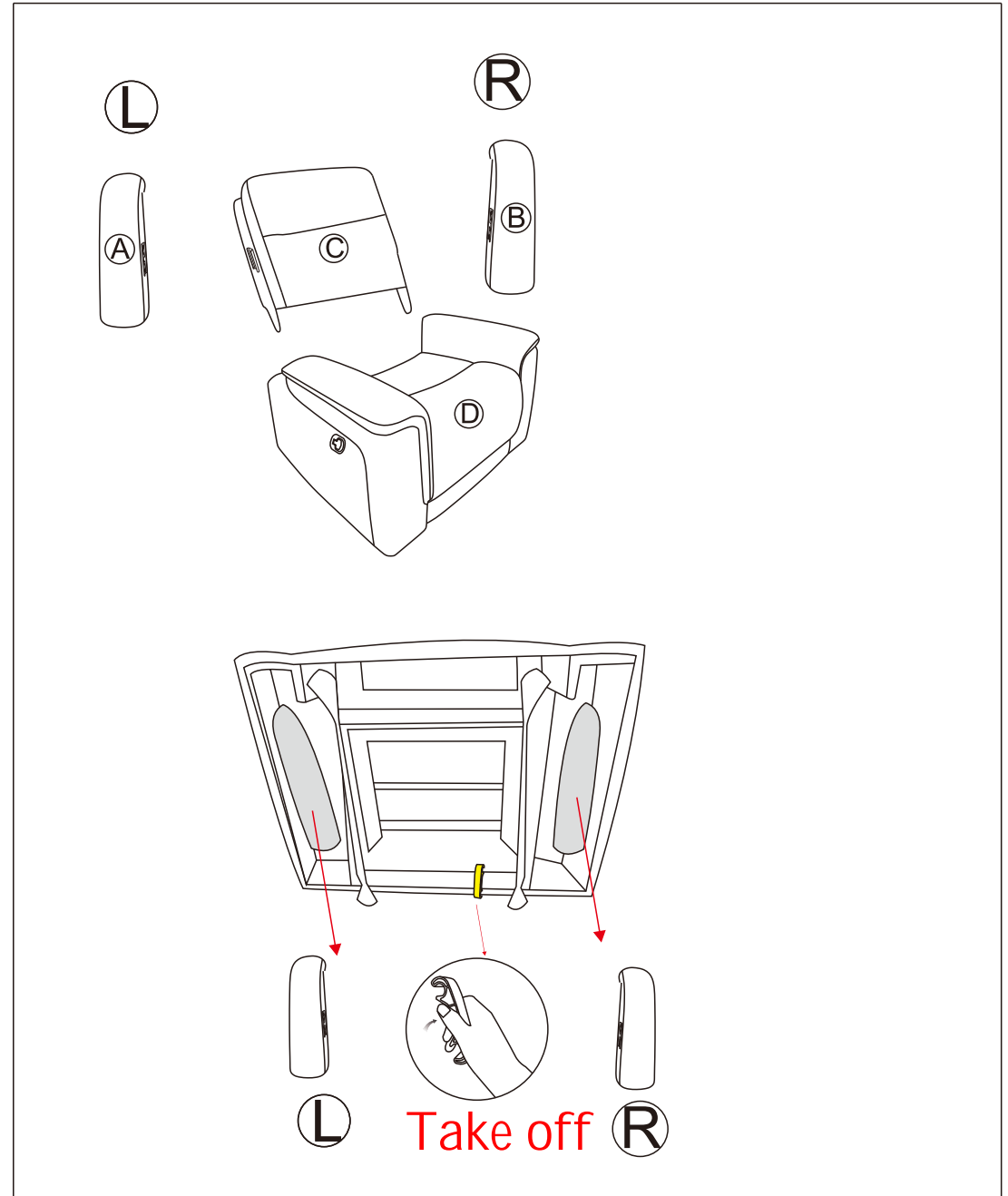

# ASSEMBLY INSTRUCTIONS

## Step 1

Install the Left Backrest(L) into the Seat by positioning the female metal receiver brackets over the male metal posts.

Ensure that female metal receiver brackets on each side of the backrest are positioned over the seat metal posts.

Push down the female brackets over male posts simultaneously until each side is locked into place an audible “click” is heard.

Install all backrests pieces in the same way described above.

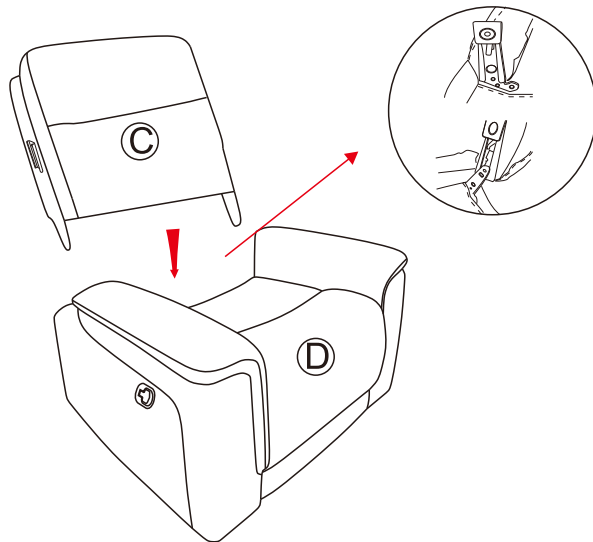

## Step 2

Install left and right wing by inserting brackets

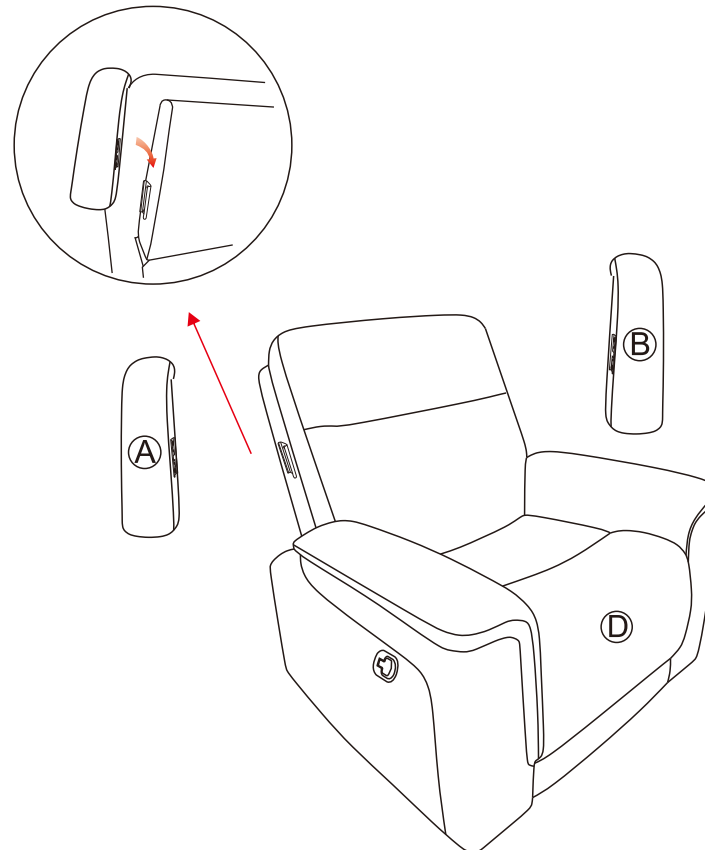

# POWER CONNECTIONS

## Step 3

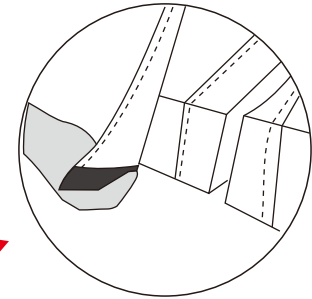
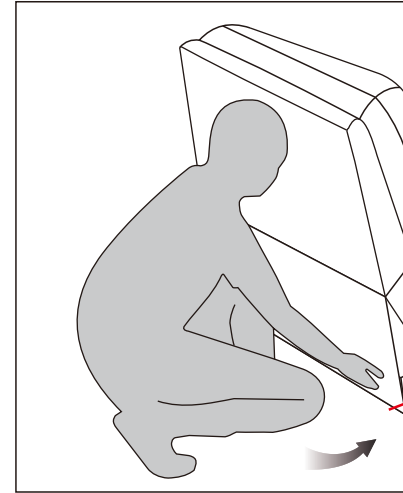
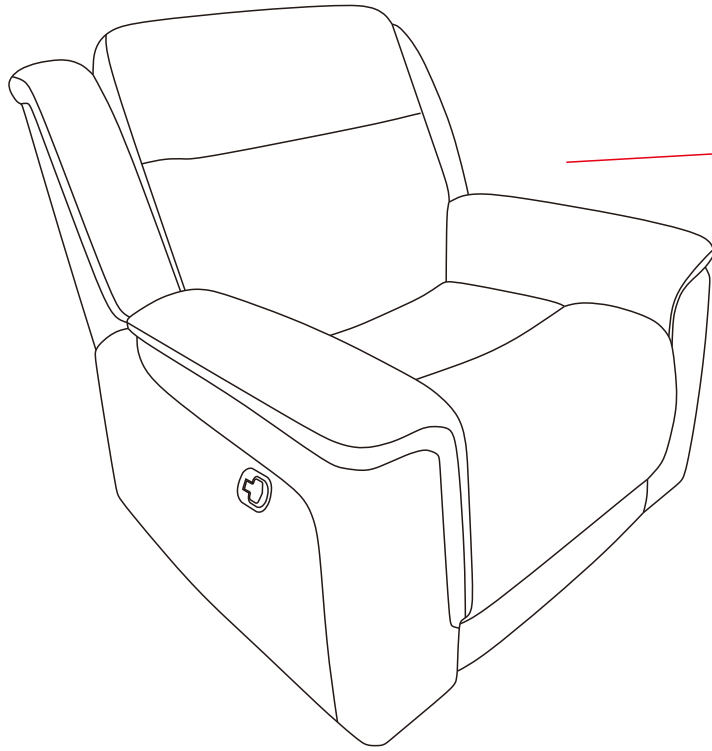

Use velcro to attach the flap to the bottom of seat frame.

# Electrical Controls

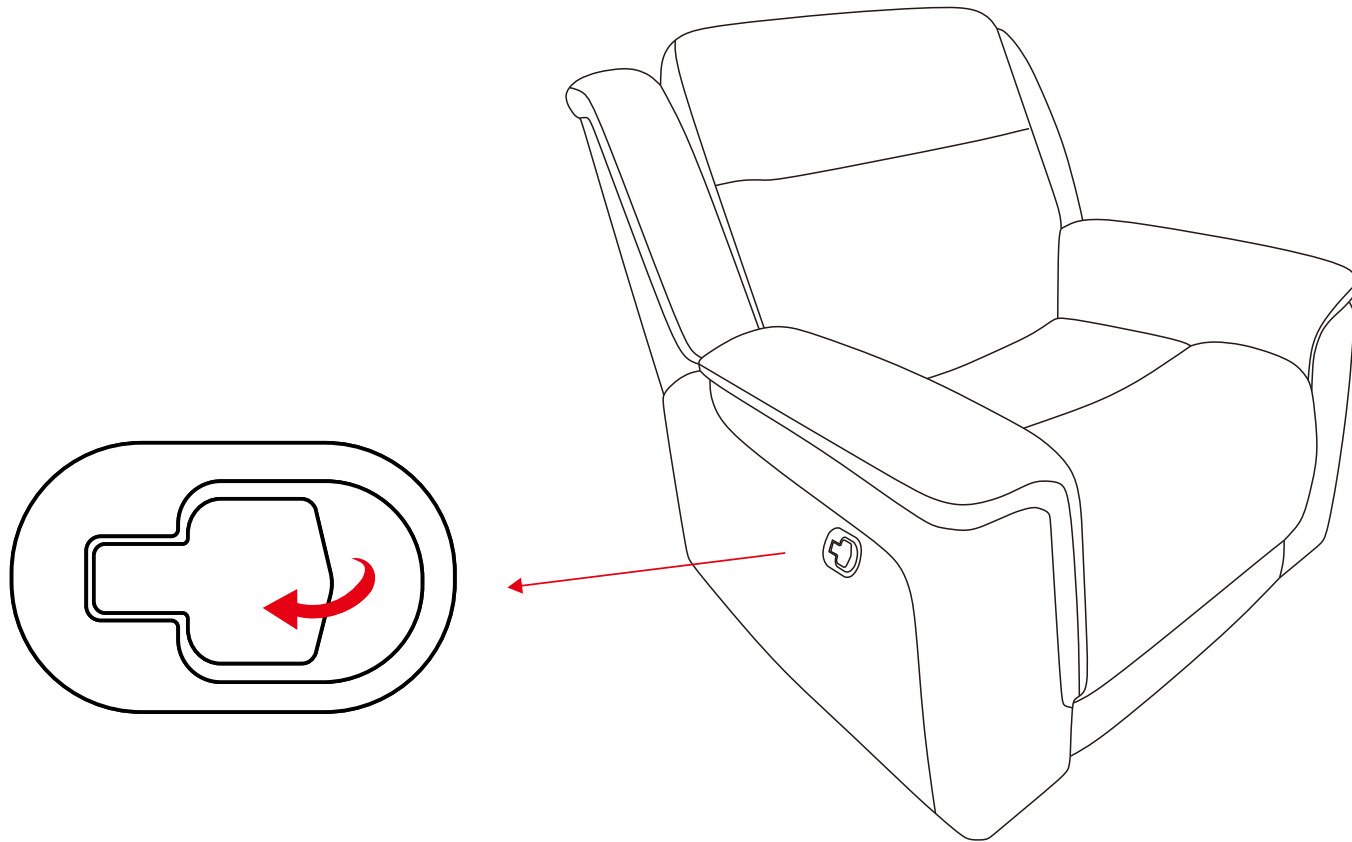

Seat forward

# WARNINGS

- \*Keep unit at least 24" from all heat sources.
- \*Avoid placing unit in areas where unit can be exposed to direct sunlight or other powerful light sources, as fading or discoloration may occur.
- \*Maintain minimum of 6" space between the furniture backs and wall.

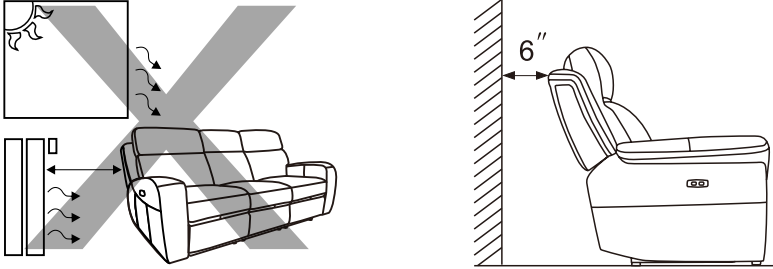

- \*Do not leave when the recliner is not fully closed.
- \*Do not reach under seat when mechanism is operating or serious injury may occur.
- \*Reclining mechanism should only be operated while seated properly.

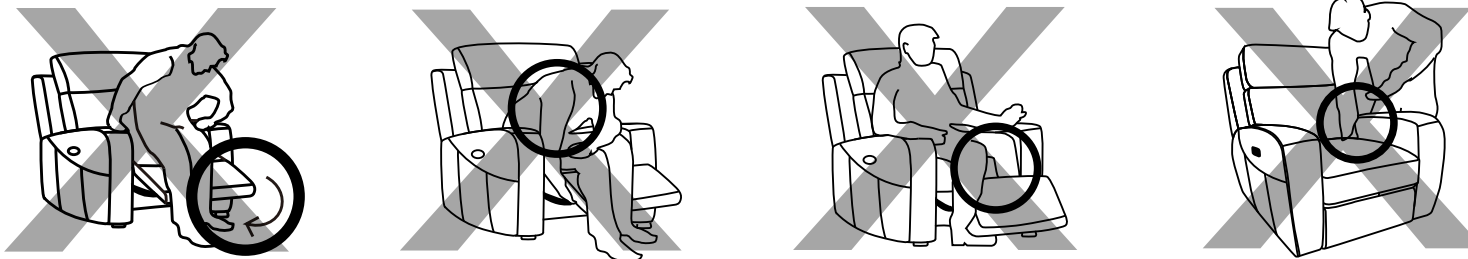

- \*Do not sit on arms or backrest.
- \*Do not jump or roughhouse on furniture.
- \*Do not sit on the footrest when mechanism is open.

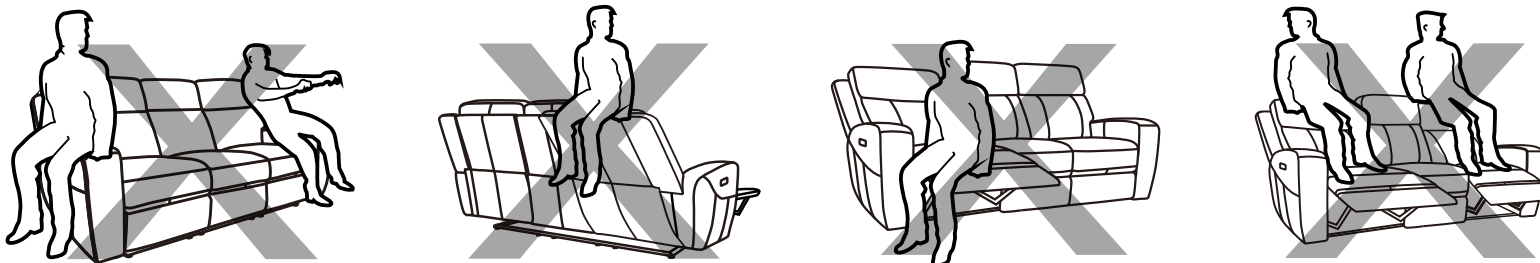

\*If unit must be moved, do not drag. Unit must be lifted in order to be moved.

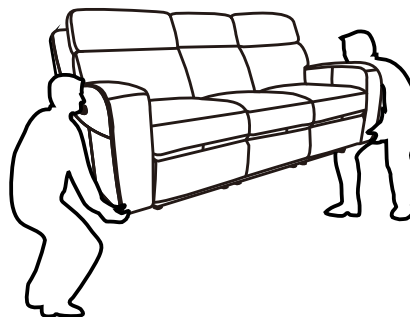
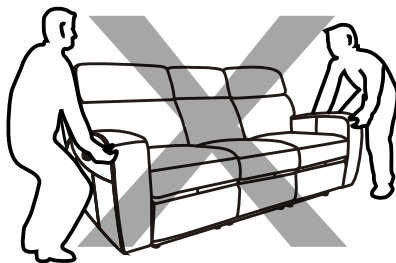
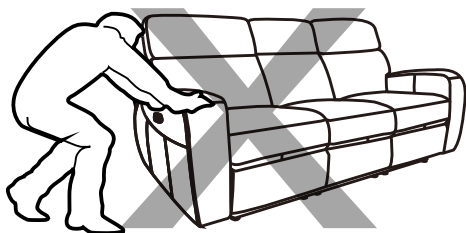

\*Do not continuously operate mechanism for more than one minute or unit may go into protection mode by shutting down to prevent overheating.

\*Unplug unit from power source prior to cleaning mechanism.

\*Do not allow electrical components to come into contact with any liquids.

## CARE AND CLEANING

\*Upholstered furniture is packaged tightly to protect it during transit. This packaging can sometimes cause creases or misshaped cushions when the furniture comes out of the packaging. These issues will correct themselves over time as the fibers of the cushions are exposed to air. However, shaping the cushions with your hands can alleviate the creases and compressed fibers more quickly.



Before shaping



After shaping

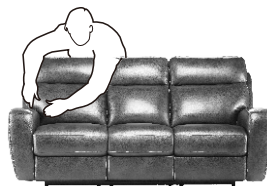

\*Dust often and use a vacuum cleaner to remove debris from seams and crevasses.

\*Use a soft damp cloth to gently clean soiled areas and wipe clean. Do not rub.

\*Do not use household cleaners or solvents. Such cleaners may cause damage and/or discoloration.

\*Do regularly use dedicated leather care product onto the leather furniture to prevent built up of body oils.

# TROUBLESHOOTING

PROBLEM	SOLUTION
Backrests gaps	Ensure the backrests are properly clipped into the male posts located on seat mechanism.(Step 1 2) Check that brackets are not loose, positioned improperly or bent.