



Assembly Instructions

SKU #

CHAT CA43





CA Chair

14300470

14300432

14300468

14300482

Code	Hardware	QTY
A	Allen key 	1 pc
B	Short leg 	2 pc
B	Bolt 4 x 2,5 " 	6 pc
C	High leg 4 x 2 " 	2 pc
C	Bolt 4 x 2 " 	6 pc

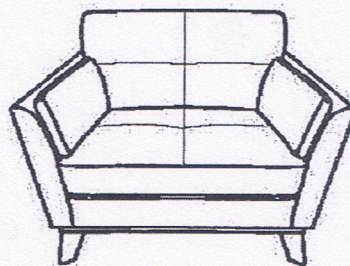

*** Caution: Please read all the instructions carefully before starting the assembly process. These parts are cumbersome and heavy. Therefore, two people are recommended in order to prevent personal injury and insure the parts are not damaged during the assembly.

STEP 1:

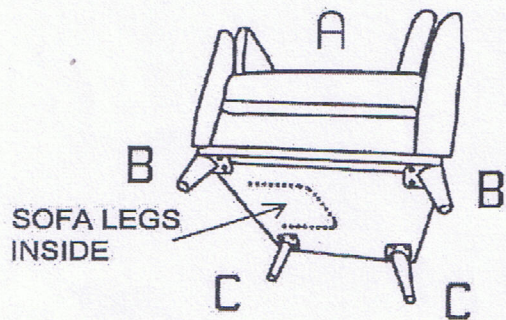

Open the zipper and take the legs out

STEP 2:

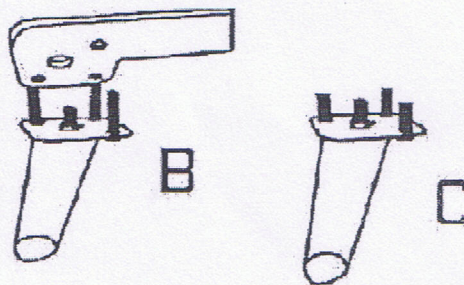

Install the high bolts into the short leg and the short bolts into the high leg.

STEP 3:

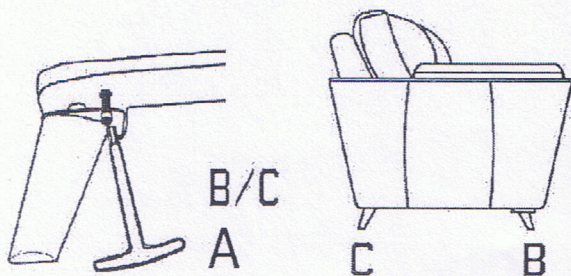

Please screw the bolts clockwise on the feet into the plate, until fully in position.

