

SKU

DRCL 14146117 / 14246119 / 14346111 / 14446113
14146129 / 14246121 / 14346123 / 14446125

4611

Care and User Instructions - Please keep for future reference



Important - Please read these instructions fully before using the product



Safety and Care Advice

Important - Please read these instructions fully before starting assembly

- Make sure you have enough space to work and layout the sofa.
- Assemble the sofa as close to its final position (in the same room) as possible.
- Assemble on a soft level surface to avoid damaging the sofa or your floor.
- Parts of the assembly will be easier with 2 people.
- Remove the protective cellophane wrapping the sofa. Do not use sharp tools that may damage the sofa covering.
- Feet and accessories can be found by opening the zip underneath the sofa. To access this zip spread the cellophane sheet on the floor, lower the sofa so that the rear back panel rests against the floor. Remove package containing the feet and accessories, then install the feet.
- Once feet are securely attached return the sofa to an upright position. To do this the sofa must be lifted and turned. Avoid using the feet as a lever as doing this may lead to damage.
- Dispose of all packaging carefully and responsibly.

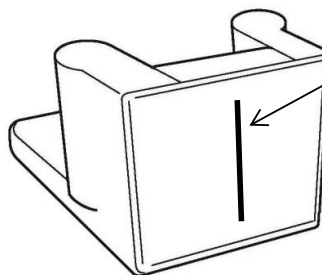
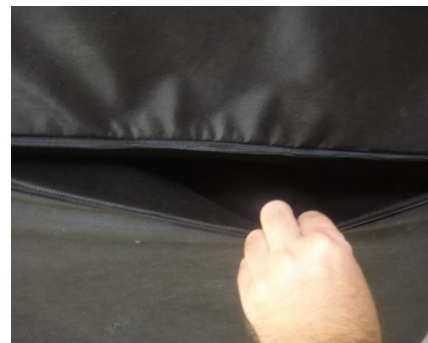

Before your furniture leaves the factory, it is given a final inspection prior to secure wrapping for distribution. Due to tight and secure wrapping to minimise movement during transit, when unwrapped, the chair may appear a little "distressed". This is entirely normal, and the illustrations below show how to rectify this in 3 easy steps:



Step 1

With clean movements bring the back cushions of the chair back to their original shape.



Step 2

Spread the leather evenly across the seat cushions with the palms of your hands



Step 3

Give the arm pads a good plump and then straighten them as shown.



Feet Assembly

Fixtures and Fittings supplied

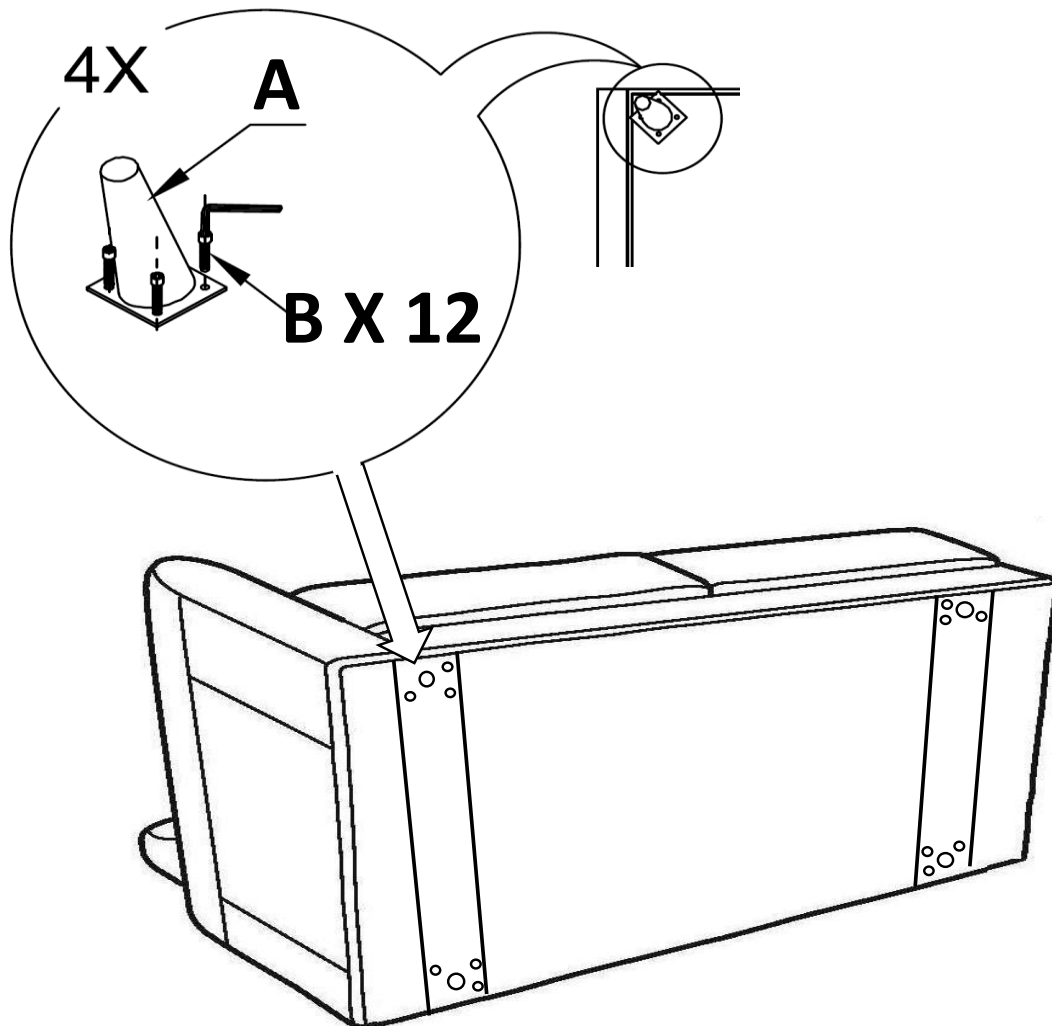
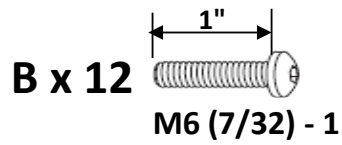
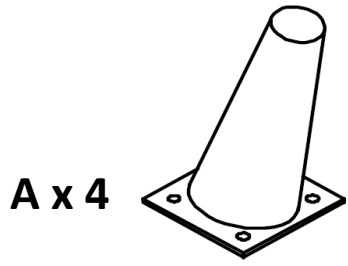



Safety and Care Advice

Care and maintenance

- Keep a minimum distance of 8"-12" between your furniture and any source of heat i.e. fires or radiators.
- Avoid exposing the sofa to direct sunlight or to powerful lamps to as this may result in the leather fading. Protect it by drawing curtains or blinds.
- Vacuum or use a soft brush weekly as accumulated dust and dirt will wear and dull the material.
- **Zips** are fitted to assist in the ease of manufacture and do not necessarily mean the cover is removable for washing or cleaning.
- **Loose Threads** should be cut carefully not pulled as this may unravel the stitching.
- **Biro:-** Remove any Biro marks immediately as the ink will eat into the leather.
- **Beware of sharp or hot objects :-** Buckles, keys, toys and jewellery can easily snag on the fabric and cause tears and pulls. Hot objects, such as heat from mugs or cups can permanently disfigure upholstery.
- **Do not** move the sofa by pushing or pulling it by the arms on smooth or rough surfaces. If the sofa has to be moved the correct way to do so, is by lifting it from the base with two persons. Improper handling may lead to the feet or stitching to be damaged.
- **Excessive Force :-** Use your sofa responsibly. Do not jump on the sofa and avoid sitting on the edges of cushions and arms as this may cause distortion and permanent damage.

Restrain children from climbing or jumping on the furniture, especially in shoes.

- Especially do not allow domestic pets to claw or climb on the sofa, they have sharp claws which can scratch the leather. Their saliva is very harmful to leather as are their body fluids and oils.
- The product is designed for interior use only. When the time comes to discard it, do not dispose of the sofa improperly but make use of public waste disposal systems.

- **Avoid**

Wearing dark clothing especially denim jeans

Leaving newspapers lying on the furniture

Both of the above can result in dye/print being ground into the fabric and can result in cream/pale finishes going grey in colour.

Pets sleeping / lying on the furniture, as their natural body oils/hair/saliva can cause damage to the leather finish.

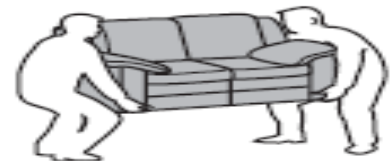
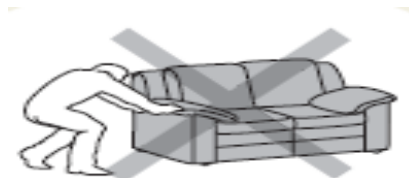



Safety and Care Advice

Cleaning Information Leather

Thorough Cleaning

Thorough Cleaning is recommended at least every 6 months to remove the gradual accumulation of body oils, perspiration, skin acids and general soiling (this includes the oils/hair from pets)

Use a specialist cleaning kit, taking into account any advice supplied by the manufacturer

BEFORE USING ANY CLEANING AIDS, PLEASE READ THE INSTRUCTIONS CAREFULLY AND TEST ON A HIDDEN AREA FIRST.

EMERGENCY CLEANING

If a major spill has occurred requiring immediate attention, do the following:

- Use a mild unscented soap with distilled water
- Dab the spot carefully with the solution
- Avoid soaking the leather
- Allow to air dry

IF UNSURE SEEK THE ADVICE OF A PROFESSIONAL

DO NOT USE

- Harsh chemicals like acetone (nail polish remover), bleach, house-hold cleaners or stain removers
- Coloured shoe polish as it will run onto clothes
- Spray polishes, saddle soaps, waxes, "Hide foods"

These create a sticky surface attracting dirt and causing irreversible damage, which can over time, build up layers which will eventually crack, damaging the leather underneath.

Cleaning Information Fitted Covers

Accidental spillage

Where possible:

- Always tip liquid spillages from the surface of the fabric
- Blot excess liquid with tissues or toilet roll
- If necessary, sponge the area but do not over wet as water can shrink fabrics or their backing fibres.
- Remember to damp a complete panel to avoid marking
- Always remove stains in the direction of the pile, if any. **BE GENTLE** - do not rub or scrub as this will only spreads the stain and can damage fabrics

General dirt and stains

- Use a clean damp cloth (not wet) and if necessary use a gentle cleaning aid
- Never use hot water as this can set the stain into the fabric
- Do not use detergents as these can cause colour loss and leave sticky residues

Follow cleaning symbol guidelines as shown below

Grease or oil based stains

- Use a propriety spot cleaner working from the edge of the stain inward to avoid spreading
- If possible, treat the stain from the wrong side of the fabric and never use a hard scrubbing action

Water based stains

- Use a specialist upholstery cleaner/shampoo. If a specialist cleaner is not available a very weak (2%) solution of washing powder can be used in hot or cold water
- Use the mixture sparingly
- Dab gently from the outer edge, inward
- Dab out shampoo afterwards using warm water

DO NOT SOAK

Cleaners are available from most supermarkets and hardware stores

BEFORE USING ANY CLEANING AIDS, PLEASE READ THE INSTRUCTIONS CAREFULLY AND TEST ON A HIDDEN AREA FIRST





Safety and Care Advice

Attention :

- Natural leather is a noble and resistant material, which becomes more valuable over time. Its transpiration properties make it warm in winter and cool in the summer, and its flexibility allows it to mold perfectly to the body's shape. Characteristics such as healed scars, wrinkles, insect bites, breaks, veining and variations in grain and colour are natural features of hides of leather that give them their value and natural character. These characteristics should not be viewed as defects, but as confirmation that you have purchased genuine leather and not an imitation. These markings will depend on the grade of leather you have selected.
- During the first three months of use the polyurethane foam padding used in the seats tends to become softer and then finally stabilizes itself. This process is absolutely natural as when pressure is applied on the seating the micro-cells that comprise the polyurethane break down. This process is perfectly normal for this kind of material and produces a slight softening effect. As above, it is absolutely normal that the softness of a seat / back padding is found to be different from the one adjacent, depending on its usage. Light creases may form on the covering following the abovementioned natural setting of the padding, which are to be considered absolutely normal and depend on the settling of the leather.