





Assembly Instructions

SYNE 2111-73PHR-Air Loveseat Recliner Console w/pwer Headrest, Air massage

SKU# 15202118/15202120

Manufactured for Rooms To Go

*****CAUTION: The item is heavy, assembly should be performed by two people in soft surface.**

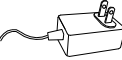
| Parts# | Desc. | Pattern | Q'ty | | Desc. | Pattern | Q'ty |
|--------|--------------------------------|---|----------|---|---------------|---|----------|
| A | Washer |  | 4 pieces | B | Butterfly nut |  | 4 pieces |
| C | Bolt (M8*3.14", 18 threads per |  | 4 pieces | D | Transformer |  | 2 pieces |

- 1) Please note that the arm pad has left side and right side. We stick the label " Front/left" and "Front/right" on the arm pad and arm base.
- 2) The bolts package with a sticker "hardware" is attached to the bottom of base rail.(See Figure 1)
- 3) Attached each bolt to corresponding pre-drilled holes by hand turning on clockwise direction as figure underneath. (See Figure 2) Please attached to Screw the shorter threaded end of the bolt into the armrest and follow the arrow direction to Insert the longer threaded end of the bolt into the hole in the base (Figure 3).
- 4) Please place the washers and Butterfly nut into the bolt as show by hand and then turning in clochwise direction until it is tight.(See Figure 4)

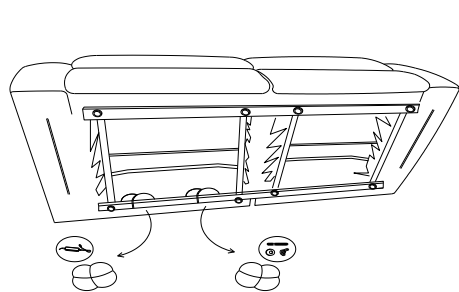

Figure 1

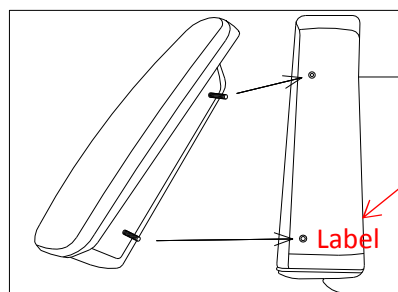

Figure 3

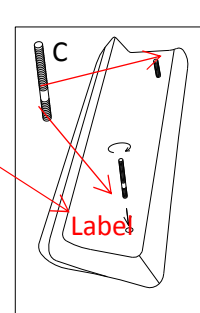

Figure 2

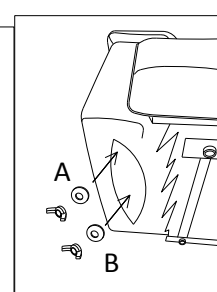
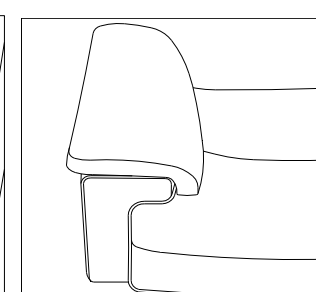
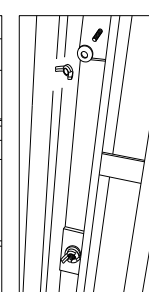
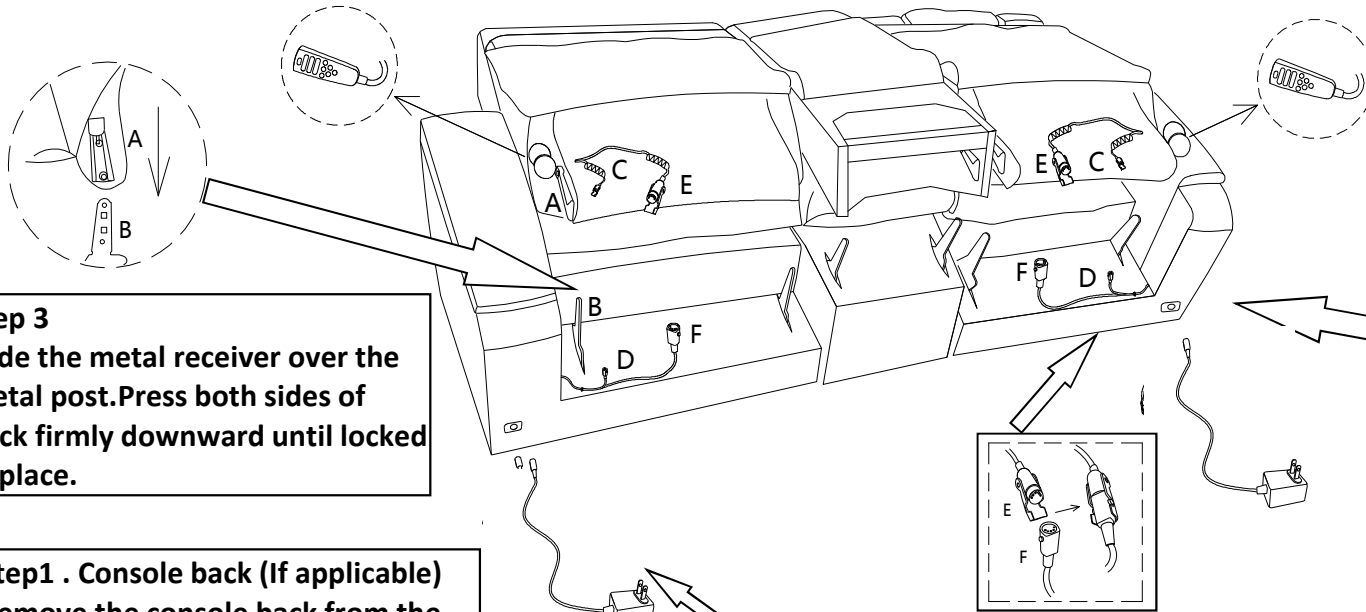

Figure 4





Step 3
Slide the metal receiver over the metal post. Press both sides of back firmly downward until locked in place.

Step 1 . Console back (If applicable)
Remove the console back from the bottom of the console.

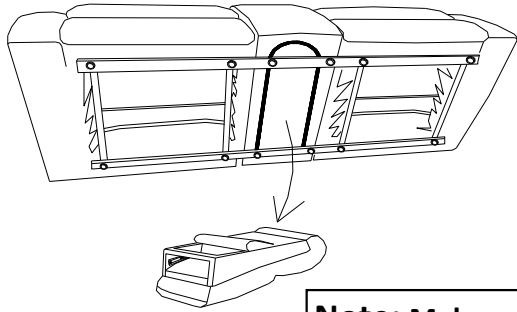

Step 2
Please located the hand controller at the beside of metal bracket.

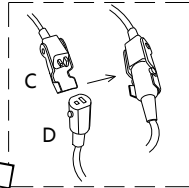

Step 4
Locate the power cord C attached to the bottom back and connect to plug D located at the rear of

Step 6
The Transformer is attached to the bottom of rail and connect to DC Port located at the rear of

Step 5
Locate the power cord E attached to the bottom back and connect to plug F located at the rear of seat.

Note: Make sure all PLUGS are connected on the product before plugging power cord into power outlet. If not damage can occur.
The USB ports (where applicable) are designed with working voltage of 5V, and can NOT be used to supply power for laptop computers (neither PC or Mac). Plugging a laptop computer to the USB port may end up damaging either the computer or the USB port due to unmatched working voltage.