



Assembly Instructions



SYNE 1857B-73PHR Reclining Console Loveseat w/Pwr headrest

SKU# 15208538 15208514 15208526

Manufactured for Rooms To Go

*****CAUTION:** The item is heavy, assembly should be performed by two people.

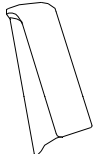
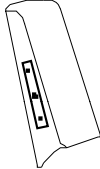
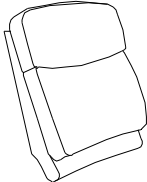
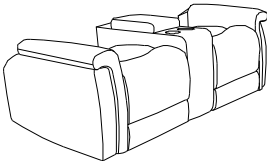
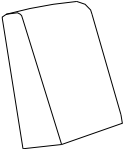
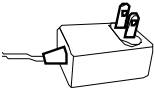
Parts and Hardware List

No	Description	Image	Qty	No	Description	Image	Qty
A	LSF Wing		1	E	RSF Wing		1
B	LSF Back Cushion		1	F	Loveseat console Recliner Base		1
C	Console Back Cushion		1	G	Transformer		1
D	RSF Back Cushion		1				

Step 1
Slide the metal receiver over the metal post. Press both sides of back firmly downward until locked in place.

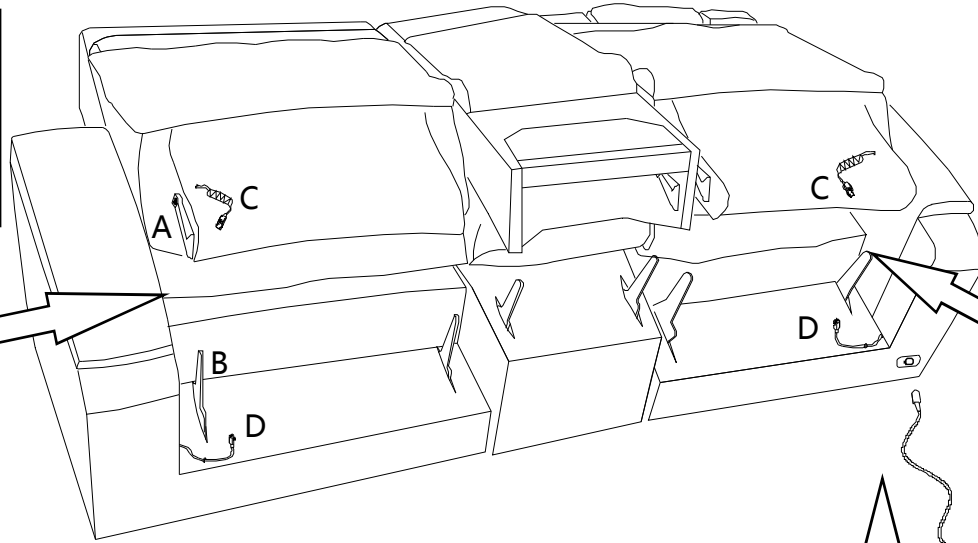
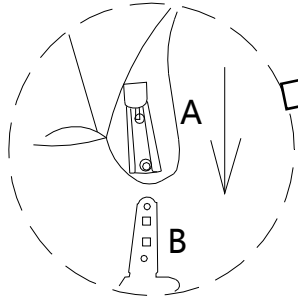

Step 2
Locate the power cord C attached to the bottom back and connect to plug D located at the rear of seat.

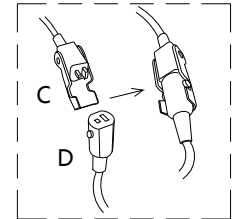

Step 3
Insert the male KD Bracket into the slot of the female Bracket pressing firmly downward until the frame is tight.

Step 4
The Transformer is attached to the bottom of rail and connect to DC Port located at the rear of arm.

Note: Make sure all PLUGS are connected on the product before plugging power cord into power outlet. If not damage can occur. The USB ports (where applicable) are designed with working voltage of 5V, and can NOT be used to supply power for laptop computers (neither PC or Mac). Plugging a laptop computer to the USB port may end up damaging either the computer or the USB port due to unmatched working voltage.

