

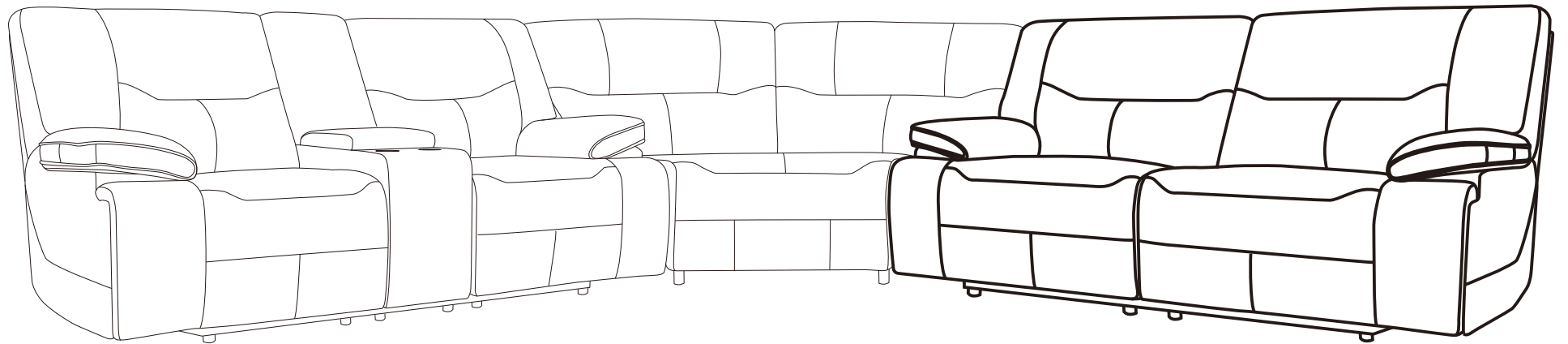

YOUZ E2968
RECLINING SOFA

SKU:15229683
SKU:15229695





Manufactured for Rooms To Go

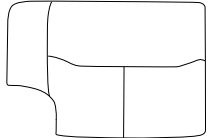
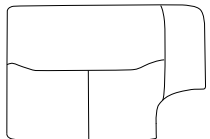

List of Parts

TOOLS REQUIRED:NO TOOLS REQUIRED

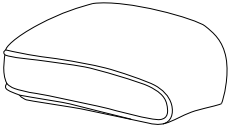
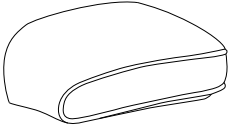
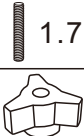
PART LIST

NO	Description	Sketch	Quantity
A	LAF Back		1
B	RAF Back		1
C	BODY		1
D	LAF ARM		1
E	RAF ARM		1
F	Screw and Nut	 1.77"*45*Φ0.23"  0.79"*M6	4 sets

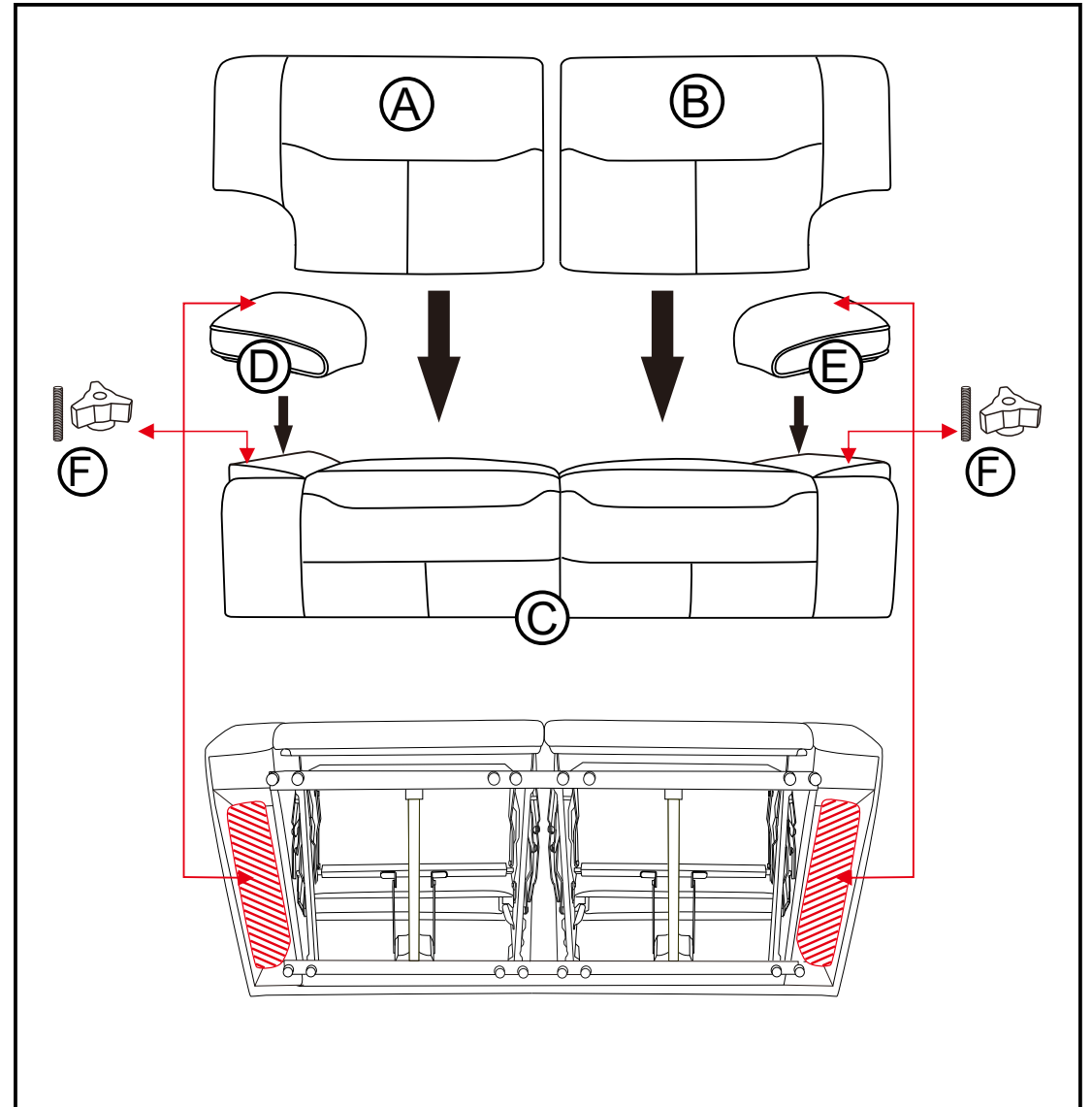

ASSEMBLY INSTRUCTIONS

STEP 1:

Attach 2 screws onto bottom of armrest (D), then install armrest (D) by inserting 2 screws into pre-drilled holes on arm frame of sofa body (C). Screw up nuts clockwise from bottom to fix the armrest. RAF Armrest (E) installation is same as LAF armrest(D).

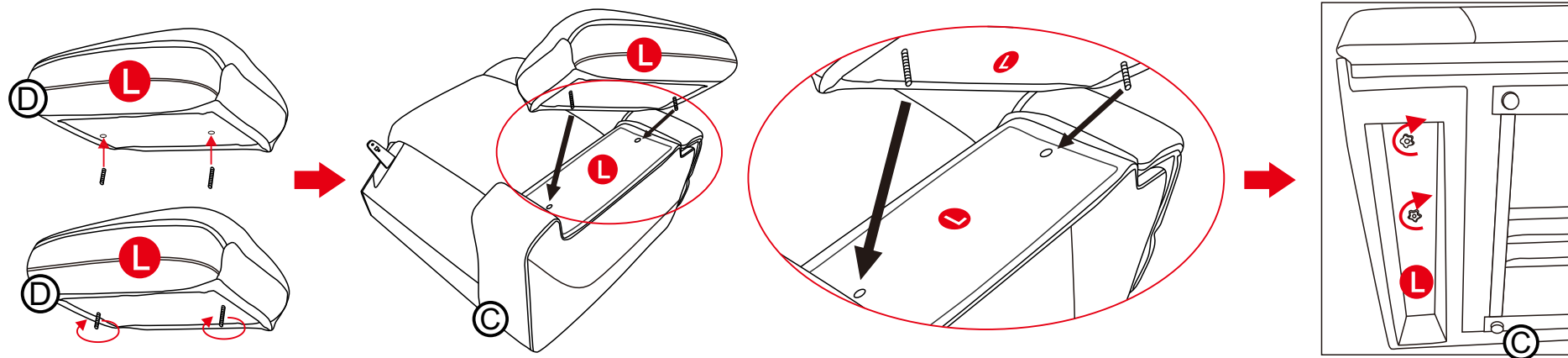

STEP 2:

Install the Left Arm Backrest(A) into the Seat (C) by positioning the female metal receiver brackets over the male metal posts. Ensure that female metal receiver brackets on each side of the backrest are positioned over the seat metal posts. push down the female brackets over male posts simultaneously until each side is locked into place an audible “click” is heard. Install all backrests of sectional pieces in the same way described above.

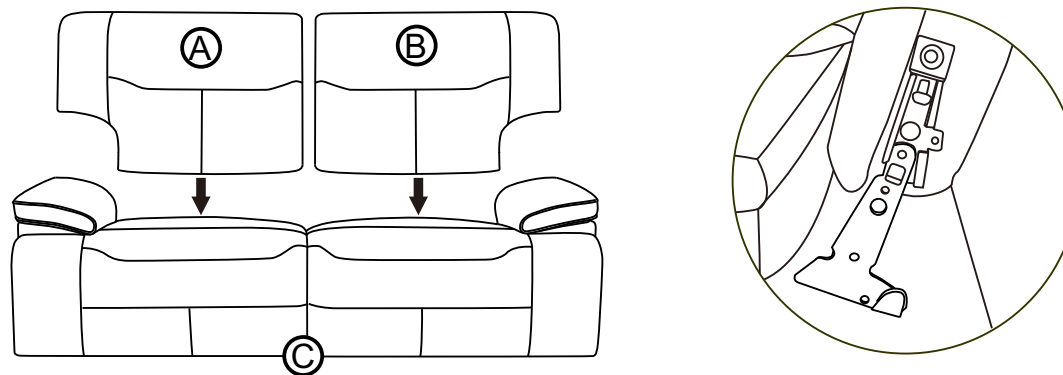

Manual Controls

STEP 3

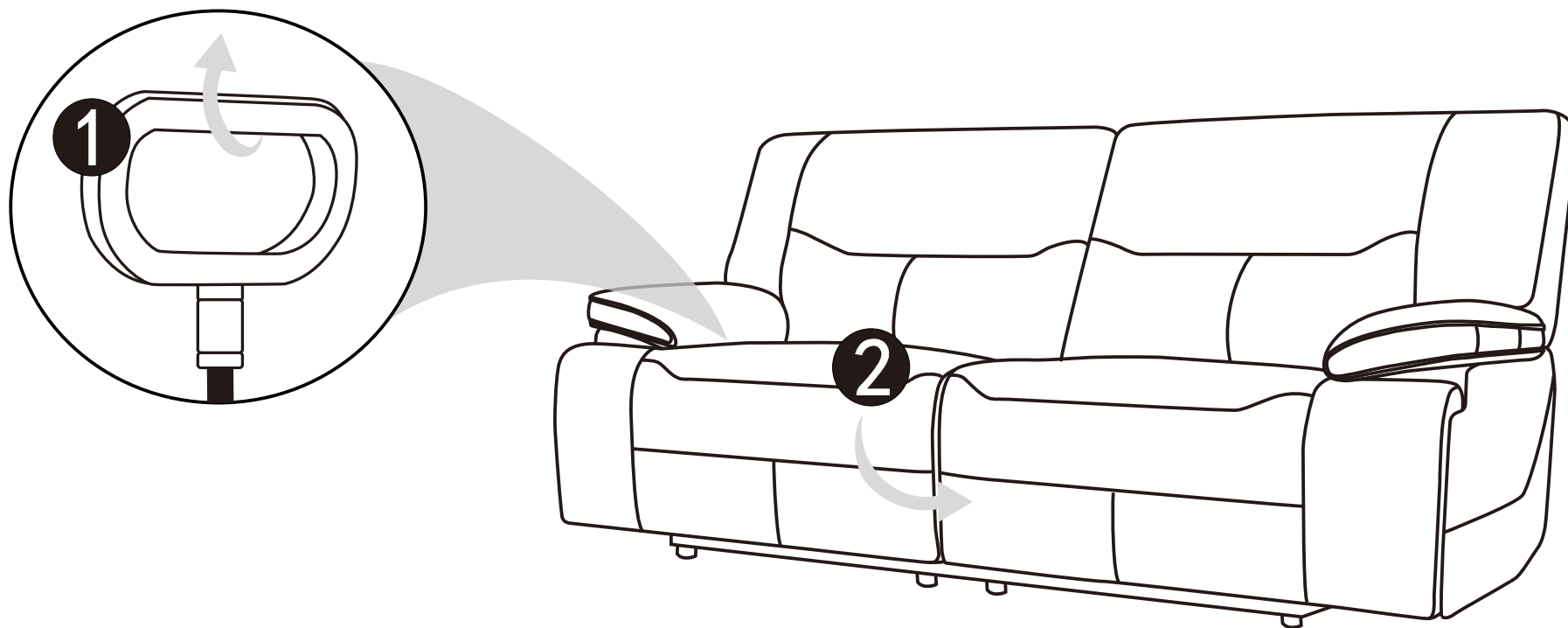

1. Pull **1** to recliner chair

2. Press footrest to restore to seat position

WARNINGS

- *Keep unit at least 24" from all heat sources.
- *Avoid placing unit in areas where unit can be exposed to direct sunlight or other powerful light sources, as fading or discoloration may occur.
- *Maintain minimum of 6" space between the furniture backs and wall.

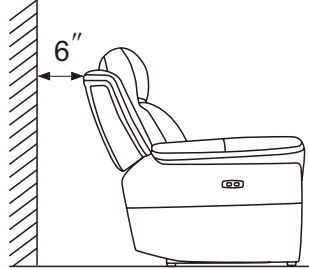
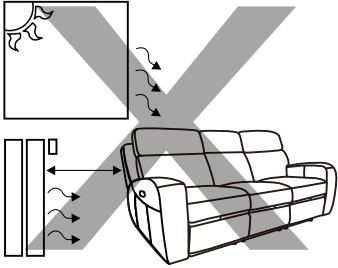

- *Do not leave when the recliner is not fully closed.
- *Do not reach under seat when mechanism is operating or serious injury may occur.
- *Reclining mechanism should only be operated while seated properly.

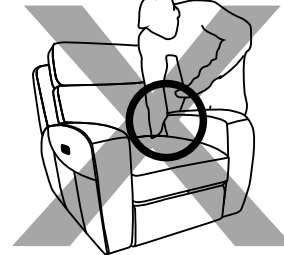
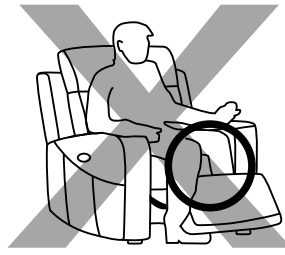

- *Do not sit on arms or backrest.
- *Do not jump or roughhouse on furniture.
- *Do not sit on the footrest when mechanism is open.

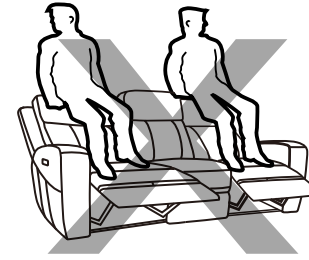
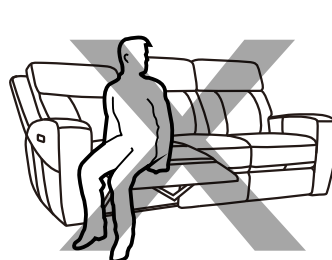
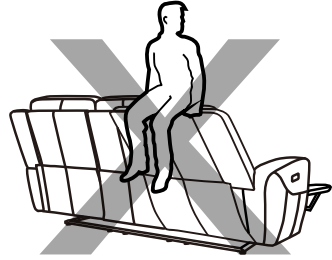
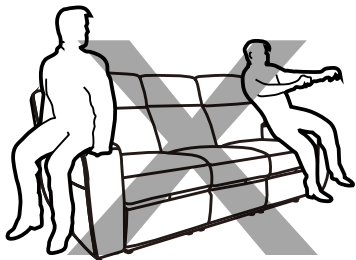

*If unit must be moved, do not drag. Unit must be lifted in order to be moved.

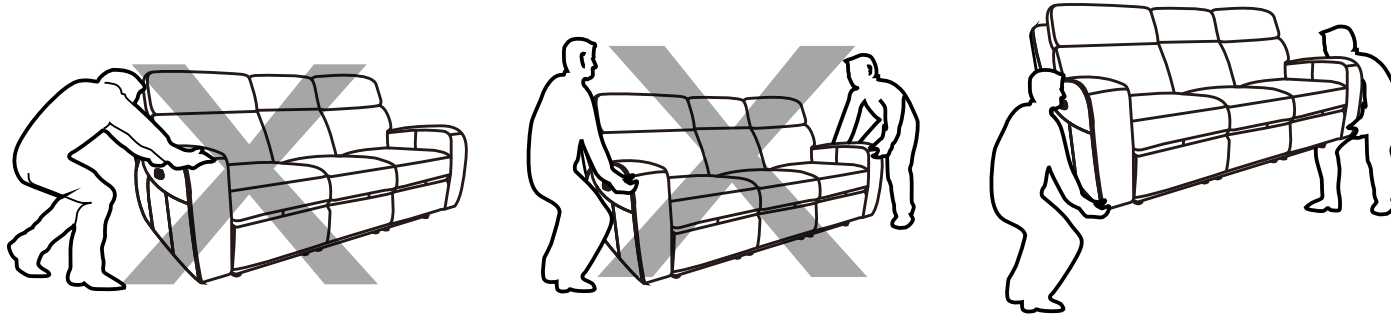

*Do not continuously operate mechanism for more than one minute or unit may go into protection mode by shutting down to prevent overheating.

*Unplug unit from power source prior to cleaning mechanism.

*Do not allow electrical components to come into contact with any liquids.

CARE AND CLEANING

*Upholstered furniture is packaged tightly to protect it during transit. This packaging can sometimes cause creases or misshaped cushions when the furniture comes out of the packaging. These issues will correct themselves over time as the fibers of the cushions are exposed to air. However, shaping the cushions with your hands can alleviate the creases and compressed fibers more quickly.

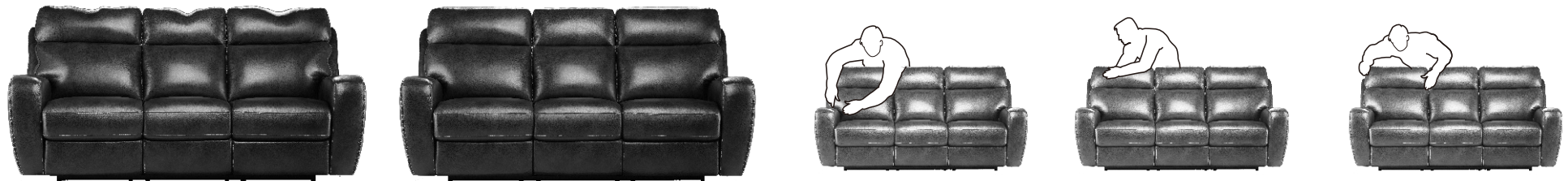

Before shaping

After shaping

*Dust often and use a vacuum cleaner to remove debris from seams and crevasses.

*Use a soft damp cloth to gently clean soiled areas and wipe clean. Do not rub.

*Do not use household cleaners or solvents. Such cleaners may cause damage and/or discoloration.

*Do regularly use dedicated leather care product onto the leather furniture to prevent built up of body oils.

TROUBLESHOOTING

PROBLEM	SOLUTION
Not Reclining	Check Step 3
Backrests gaps	Ensure the backrests are properly clipped into the male posts located on seat mechanism. (Step 2) Check that brackets are not loose, positioned improperly or bent.