



# ASSEMBLY INSTRUCTION

(Version 1, updated Nov. 2024)

TRIPLE POWER LOVESEAT WITH CONSOLE



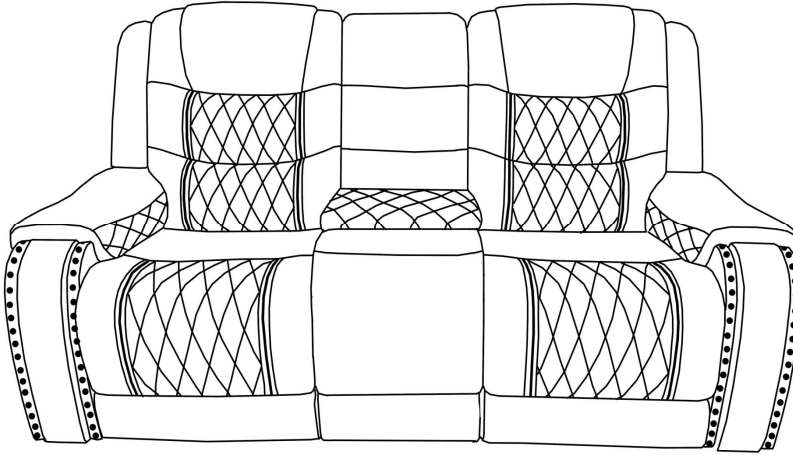

HLVN 79901 / 79902

Manufactured for Rooms To Go

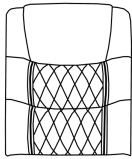

HLVN	SKU:
79901-54HL	15279905
79902-54HL	15279917

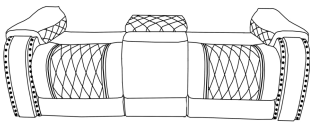
## LIST OF PARTS

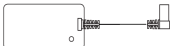
NO.	Description	Item	Quantity
A	Backrest (LSF, RSF)		2
B	LSF Wing		1
C	RSF Wing		1
D	Seat		1
E	Console backrest		1
F	Wall plug transformer		1

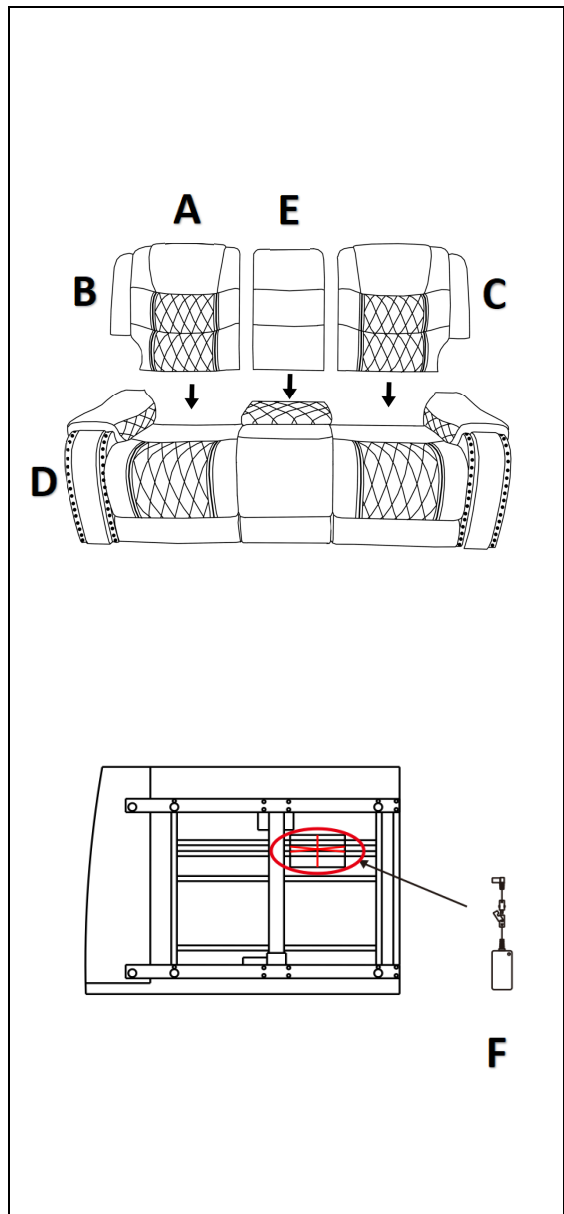

## ASSEMBLY INSTRUCTIONS

**Step 1:** Take out carefully the back cushions, wings, console's backrest & seat from the packing.

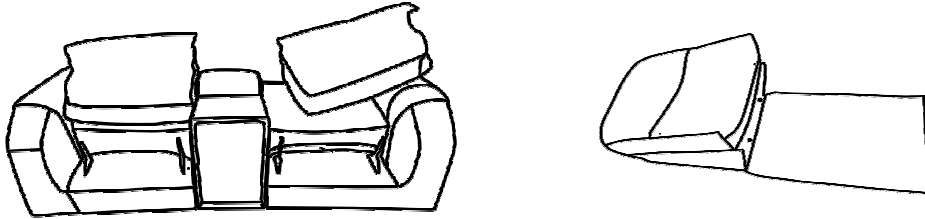

**Step 2:** Positioning the female metal receiver brackets over the male metal posts. Push down the female brackets over male posts simultaneously until each side is locked into place an audible "click" is heard.

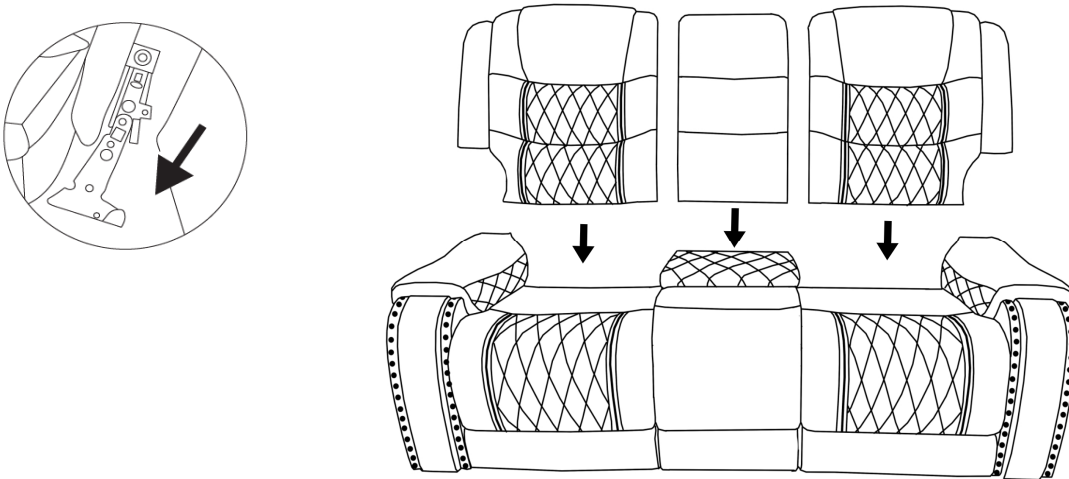

## POWER CONNECTION

**Step 3:** Lift velcro flap located at the bottom back. Latch male wire plugs from backrest to female wire receivers located at the bottom back underneath the flap. One is headrest motor wire, another is lumbar motor wire, matching by different colors. Allow sufficient space between reclining sofa and the wall behind it.

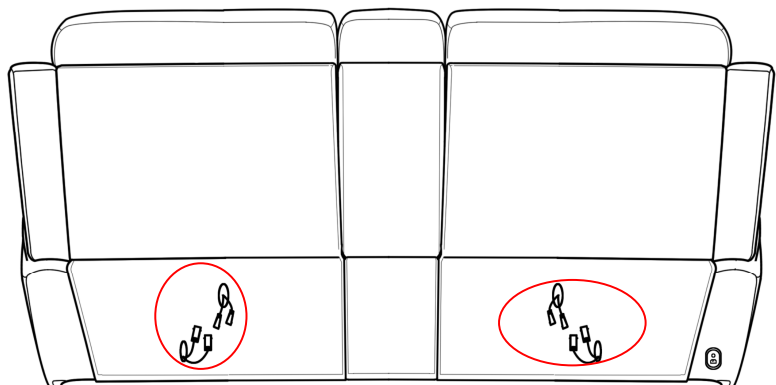
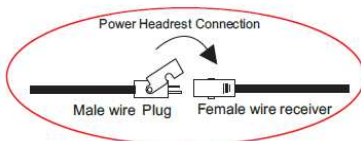

**Step 4:** Connect wall plug transformer to transformer switch.  
And connect transformer plug to electrical outlet.

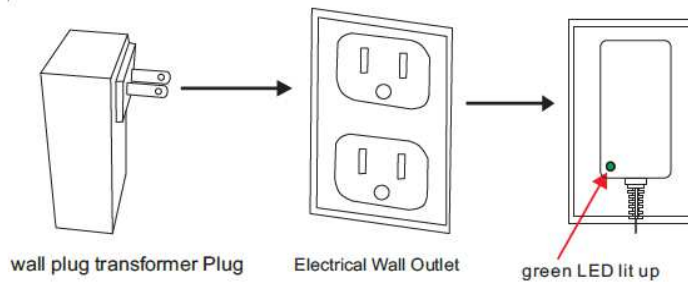
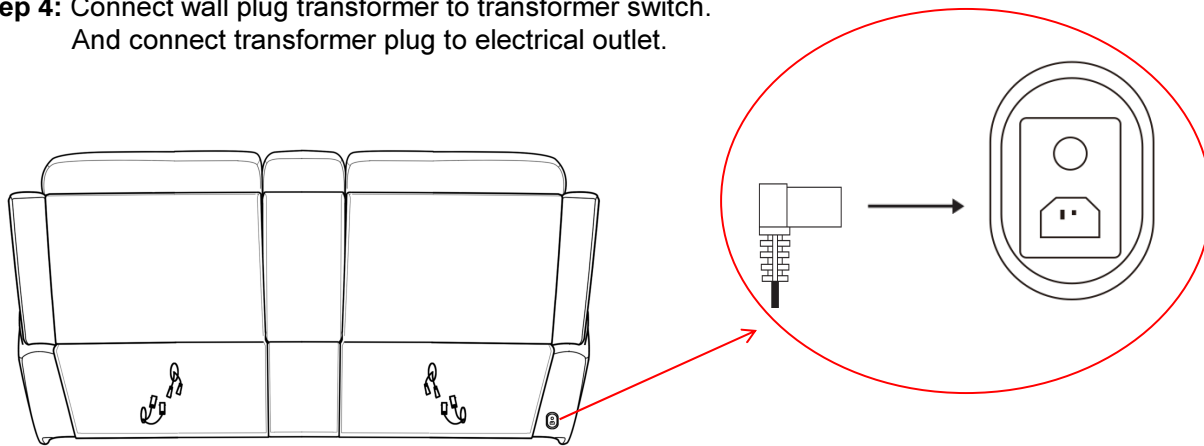

## ELECTRICAL CONTROLS

- 1 Press button to recline the sofa to desired position
- 2 Press button to raise the sofa to the upright position.
- 3 Press button to activate the headrest forward.
- 4 Press button to return headrest to the closed position.
- 5 Press button to activate the lumbar forward.
- 6 Press button to return lumbar to the closed position.
- 7 Home button
- 8 Type-C port
- 9 USB port

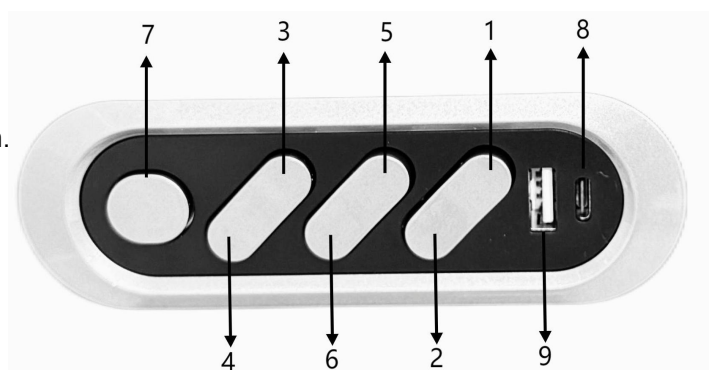

## WARNINGS

- \* Keep unit at least 7" from wall.
- \* Keep unit at least 24" from all heat sources.
- \* Avoid placing unit in areas where unit can be exposed to direct sunlight other powerful light sources, as fading or discoloration may occur.

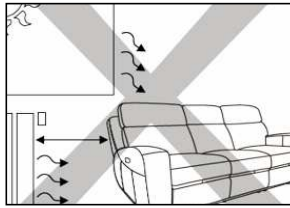

- \* Do not reach under seat when mechanism is operating or serious injury may occur.
- \* Reclining mechanism should only be operated while seated properly.



- \* Do not sit on arms or backrest.
- \* Do not jump or roughhouse on furniture

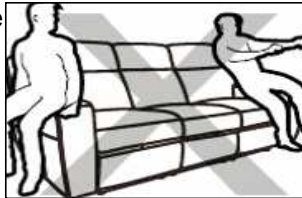

- \* If unit must be moved, do not drag. Unit must be lifted in order to be moved.

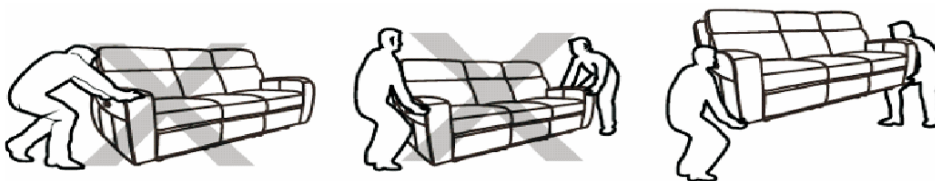

- \* Do not continuously operate mechanism for more than one minute or unit may go into protection mode by shutting down to prevent overheating.
- \* Unplug unit from power source prior to cleaning mechanism.
- \* Do not allow electrical components to come into contact with any liquids.

## IMPORTANT SAFETY INSTRUCTIONS

### **⚠ WARNING**

Misuse can result in FIRE or DEATH by ELECTRICAL SHOCK

29VDC/2A

DewertOkin Technology Group Co., Ltd.  
JLDP.10.078.221

Read all instructions before using this furnishing.

**DANGER – To reduce the risk of electric shock:**

- Always unplug this furnishing from the electrical outlet before cleaning or servicing.

**WARNING – To reduce the risk of burns, fire, electric shock, or injury to persons:**

- Unplug from outlet before putting on or taking off parts.
- Never operate this furnishing if it has a damaged electrical cord or plug, if it is not working properly, or if the electrical cord or plug has been damaged or dropped into water. Stop using this furnishing and call a service center for examination and repair.
- Keep the electrical cord and plug away from heated surfaces and other heat sources.
- To disconnect, turn all controls to the off position, then remove plug from outlet.
- When operating, ensure that electrical cord is not under the base, legs, or motion mechanism to avoid damage to electrical cord or plug.
- Do not strain or stretch electrical cord.
- Do not use extension cords or power strips.
- Keep out of reach of children. This is not a toy.
- Plug directly into a compatible electrical socket.
- Do not modify the plug or use any adapters.

## INSTRUCCIONES DE SEGURIDAD IMPORANTES

### **⚠ WARNING**

El mal uso puede provocar INCENDIO o MUERTE por DESCARGA ELÉCTRICA

29VDC/2A

DewertOkin Technology Group Co., Ltd.  
JLDP.10.078.221

Leer todas las instrucciones antes de usar este mobiliario.

**PELIGRO – Para reducir el riesgo de descarga eléctrica:**

- Siempre desenchufe este accesorio de la toma de corriente eléctrica antes de limpiarlo o repararlo.

**ADVERTENCIA: para reducir el riesgo de quemaduras, incendios, descargas eléctricas o lesiones a personas:**

- Desenchufe del tomacorriente antes de colocar o quitar partes.
- Nunca opere este accesorio si tiene un cable o enchufe eléctrico dañado, si no funciona correctamente, o si el cable o el enchufe eléctrico se ha dañado o se ha caído al agua. Deje de usar este equipamiento y llame a un centro de servicio para que lo examinen y lo reparen.
- Mantenga el cable eléctrico y el enchufe lejos de superficies calientes y otras fuentes de calor.
- Para desconectar, gire todos los controles a la posición de apagado, luego retire el enchufe del tomacorriente.
- Al operar, asegúrese de que el cable eléctrico no esté debajo de la base, las patas o el mecanismo de movimiento para evitar dañar el cable eléctrico o el enchufe.
- No fuerce ni estire el cable eléctrico.
- No utilizar cables de extensión o tomas de corriente.
- Mantener fuera del alcance de los niños. Esto no es un juguete.
- Enchúfelo directamente a una toma de corriente compatible.
- No modifique el enchufe ni utilice adaptadores.

## CARE AND CLEANING

\* Upholstered furniture is packaged tightly to protect it during transit. This packaging can sometimes cause creases or misshaped cushions when the furniture comes out of the packaging. These issues will correct themselves over time as the fibers of the cushions are exposed to air. However, shaping the cushions with your hands can alleviate the creases and compressed fibers more quickly.



Before shaping



After shaping



- \* Use a vacuum cleaner to remove dust and debris from seams and crevasses.
- \* Use a soft damp cloth to gently clean soiled areas and wipe clean. Do not rub.
- \* Do not use household cleaners or solvents. Such cleaners may cause damage and/or discoloration.
- \* Do regularly use dedicated leather care product onto the leather furniture to prevent built up of body oils.

## TROUBLE SHOOTING

PROBLEM	SOLUTION
Headrest or lumbar not working	Ensure that wall power outlets are functional Step 4
	Ensure that headrest & lumbar power cables are plugged into the seat cable Step 3
Not Reclining	Ensure that wall power outlets are operational Step 4
USB, Type-C not working	Check power connections Step 4
Backrests gaps	Ensure the backrests are properly clipped into the male posts located on seat mechanism. Check that brackets are not loose, positioned improperly or bent.