









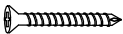

Manufactured for Rooms To Go

Assembly Instructions

SWSU 1123 STAT LOVESEAT

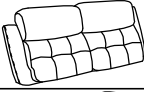
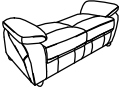
SKU#11311230
 SKU#15311234
 SKU#15311246
 SKU#15311258
 SKU#15311260
 SKU#15311272

No	Description	Hardware	Q'TY
A	Stud M8 X 90MM		4 Pcs
B	M8 x 32mm Diameter Thread Clamping Star knob		4 Pcs
C	Plastic Leg 55mm		4 Pcs
D	CSK Screw M4 x 50mm		4 Pcs
E	Flat Washer M6 x 13mm		4 Pcs
F	Left Arm Pillow		1 Pc
G	Right Arm Pillow		1 Pc
H	Backrest		1 Pc
I	Seat		1 Pc
J	Screwdriver		Not Provided

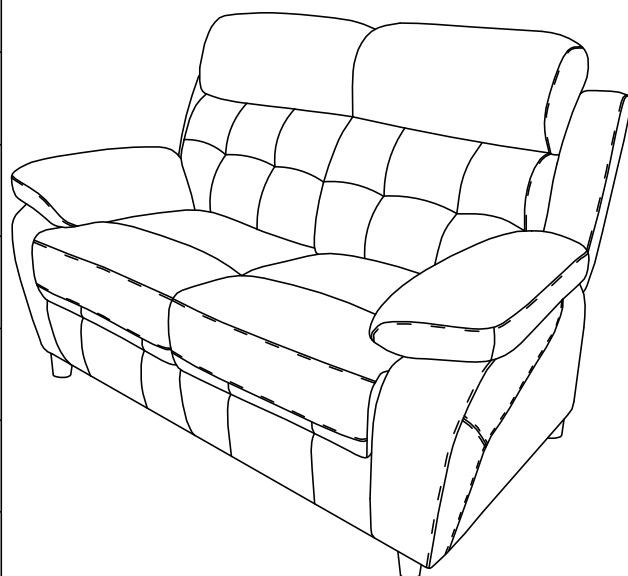



Manufactured for Rooms To Go

Assembly Instructions

SWSU 1123 STAT LOVESEAT

SKU#11311230
SKU#15311234
SKU#15311246
SKU#15311258
SKU#15311260
SKU#15311272

***Caution: Please read all instructions carefully before starting the assembly process. These parts are cumbersome and heavy. Therefore, two people are recommended in order to prevent personal injury and insure the parts are not damaged during the assembly.

Step 1:

*Remove part B from part A.

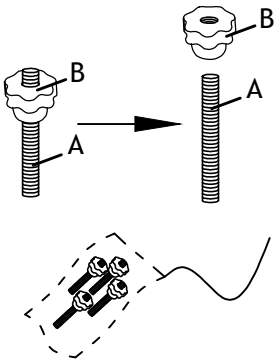

Step 2:

*Install part A into the arm pillow.

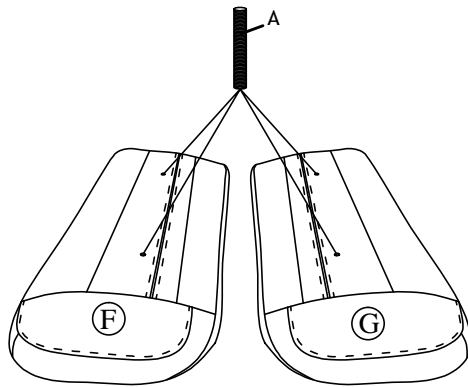

Step 3:

- (i) Place the arm pillow Right into the arm rest.
- (ii) Tight up part A with part B, J.

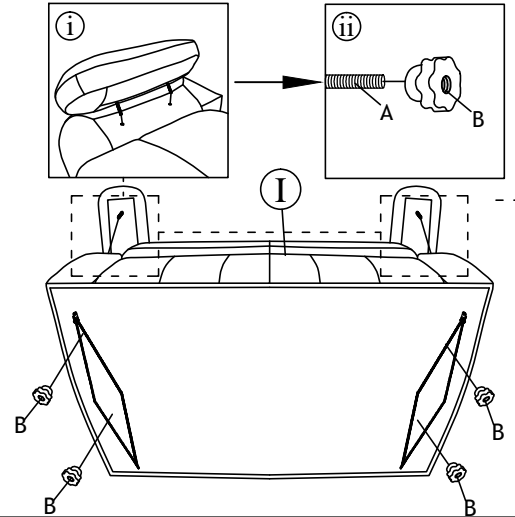

Step 4:

*Tighten the C, D, E with using the screwdriver.

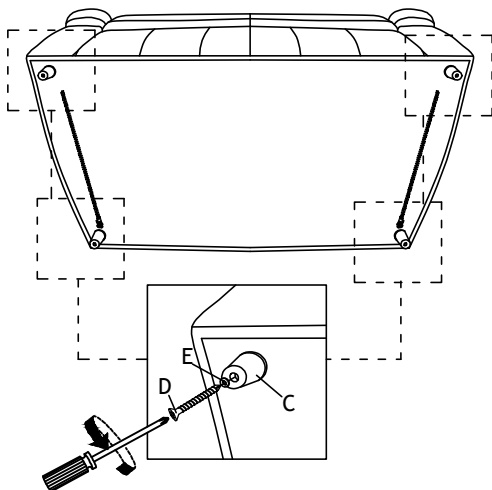

Step 5:

*Install the backrest H by positioning the female metal receiver bracket over the male metal posts.

