



Manufactured for Rooms To Go

ASSEMBLY INSTRUCTION

STATIONARY LOVESEAT

HLVN 7105R1 / 7105R2 / 7105R3

IMPORTANT: ASSEMBLING THIS UNIT NEEDS MINIMUM 2 PERSONS

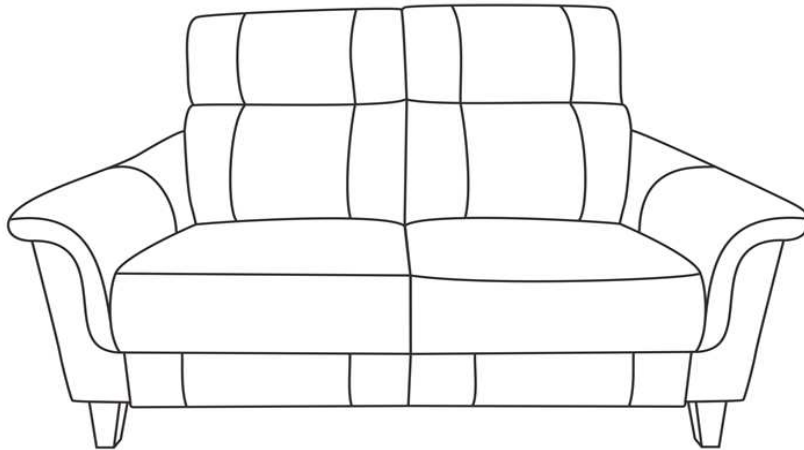



HLVN	SKU:
7105R1-02	15371557
7105R2-02	15371569
7105R3-02	15371571

Tools Required

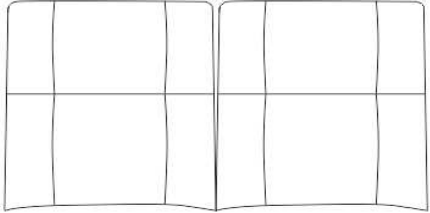
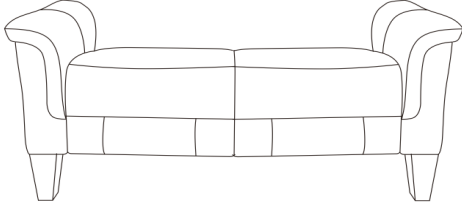

Phillips Driver

LIST OF PARTS

NO.	Description	Item	Quantity
A	Backrest		1
B	Seat		1
C	Wood Leg		4
D	Bolt		16

ASSEMBLY INSTRUCTIONS

Step 1: Take out carefully the back cushions & inner carton from the packing.

Step 2: With seat cushion facing upside down. Attach 4 pcs wood legs (using 4 bolts per leg). Metal plate have to be aligned in a certain direction as shown in the following pictures.

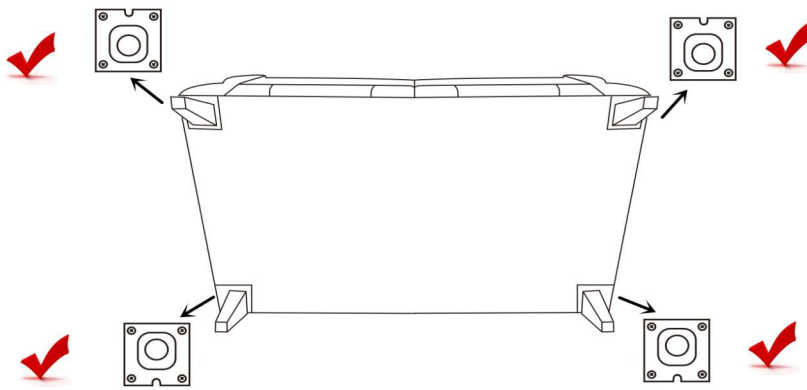

Step 3: Flip platform and cushion over so it is right side up. Test the sofa to make sure that it is level and sitting evenly on the floor.

Step 4: Place seat back cushions accordingly.

Allow sufficient space between stationary loveseat and the wall behind it.

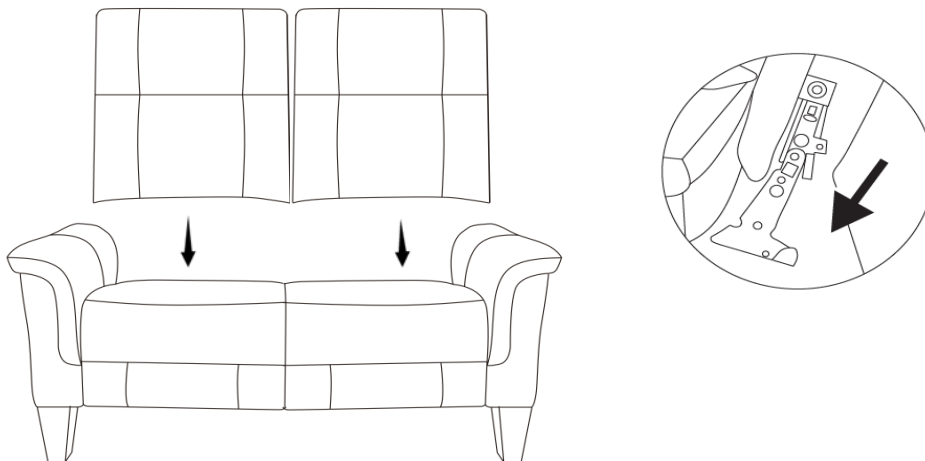

WARNINGS

- * Keep unit at least 24" from all heat sources.
- * Avoid placing unit in areas where unit can be exposed to direct sunlight other powerful light sources, as fading or discoloration may occur.

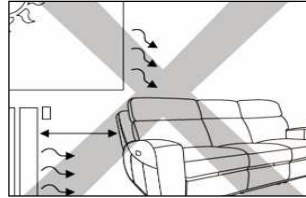

- * Do not sit on arms or backrest.
- * Do not jump or roughhouse on furniture.



- * If unit must be moved, do not drag. Unit must be lifted in order to be moved.

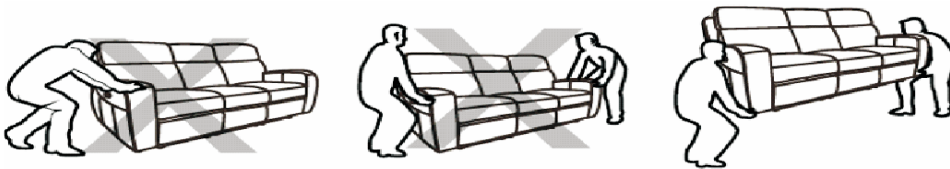

CARE AND CLEANING

- * Upholstered furniture is packaged tightly to protect it during transit. This packaging can sometimes cause creases or misshaped cushions when the furniture comes out of the packaging. These issues will correct themselves over time as the fibers of the cushions are exposed to air. However, shaping the cushions with your hands can alleviate the creases and compressed fibers more quickly.



Before shaping



After shaping



- * Use a vacuum cleaner to remove dust and debris from seams and crevasses.
- * Use a soft damp cloth to gently clean soiled areas and wipe clean. Do not rub.
- * Do not use household cleaners or solvents. Such cleaners may cause damage and/or discoloration.
- * Do regularly use dedicated leather care product onto the leather furniture to prevent built up of body oils.

TROUBLE SHOOTING

PROBLEM	SOLUTION
Backrests gaps	Ensure the backrests are properly clipped into the male posts located on seat frame. Check that brackets are not loose, positioned improperly or bent.