



Manufactured for Rooms To Go



Assembly Instructions

SYNE 1857B-10 Stationary Loveseat

SKU# 15408532 15408518 15408520

*****CAUTION:** The item is heavy, assembly should be performed by two people.

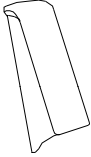
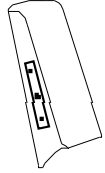
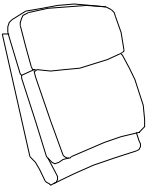
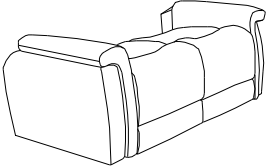
Parts and Hardware List

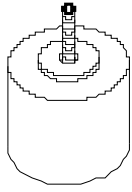
No	Description	Image	Qty	No	Description	Image	Qty
A	LSF Wing		1	D	RSF Wing		1
B	LSF Back Cushion		1	E	Loveseat Base		1
C	RSF Back Cushion		1	F	Plastic Leg		4

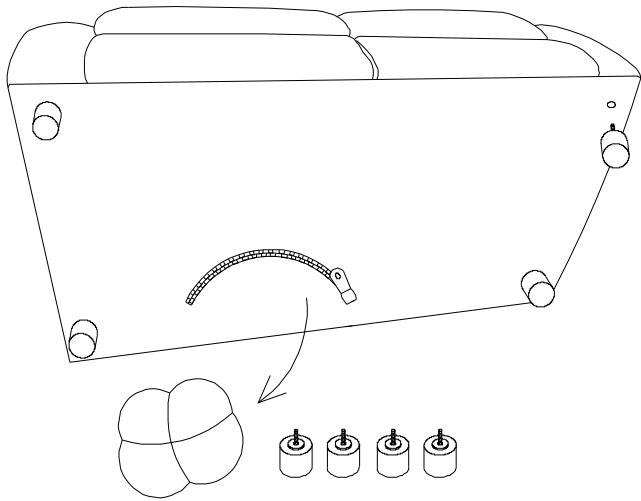

Step 1
 The plastic legs are located inside the black dust cover under loveseat. Unzip the dust Cover and remove the legs. Attach each leg to corresponding pre-drilled hole, turning by hand in clockwise direction until legs are tight.

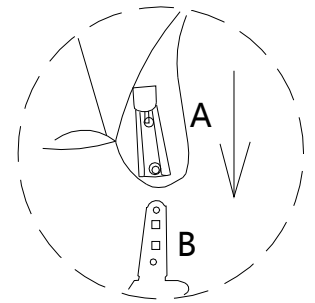
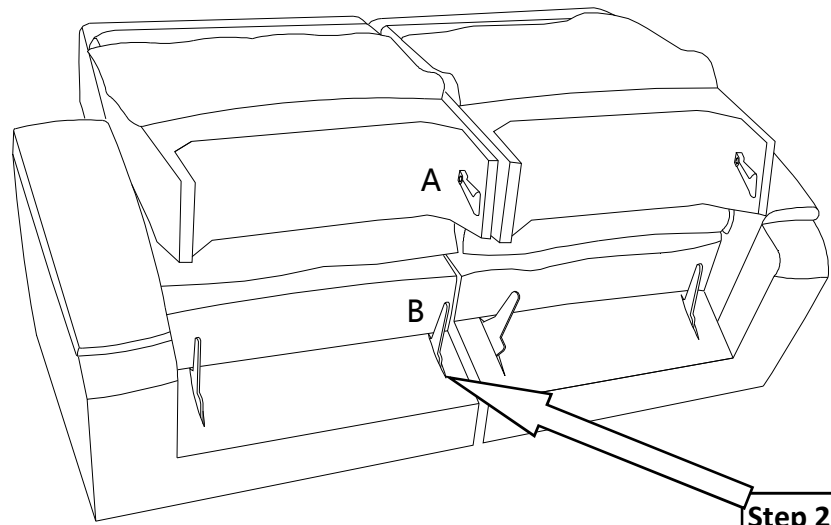

Step 2
 Slide the metal receiver over the metal post. Press both sides of back firmly downward until locked in place.

Step 3
 Insert the male KD Bracket into the slot of the female Bracket pressing firmly downward until the frame is tight.

