



## Assembly Instructions



SYNE K1857-10 Stationary Loveseat

SKU# 15485015 15485003 15485027

Manufactured for Rooms To Go

**\*\*\*CAUTION:** The item is heavy, assembly should be performed by two people.

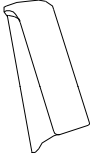
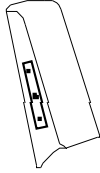
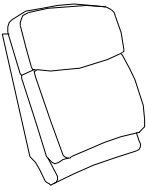
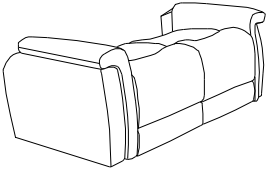
### Parts and Hardware List

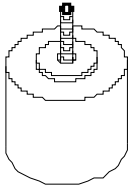
No	Description	Image	Qty	No	Description	Image	Qty
A	LSF Wing		1	D	RSF Wing		1
B	LSF Back Cushion		1	E	Loveseat Base		1
C	RSF Back Cushion		1	F	Plastic Leg		4

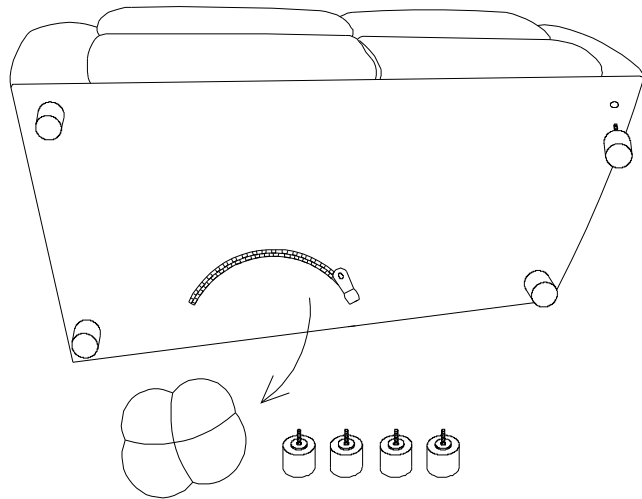

**Step 1**

The plastic legs are located inside the black dust cover under loveseat. Unzip the dust Cover and remove the legs. Attach each leg to corresponding pre-drilled hole, turning by hand in clockwise direction until legs are tight.

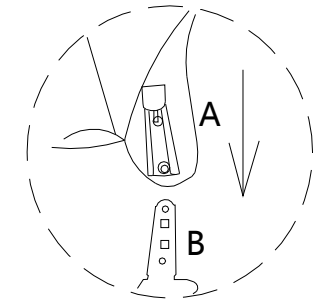
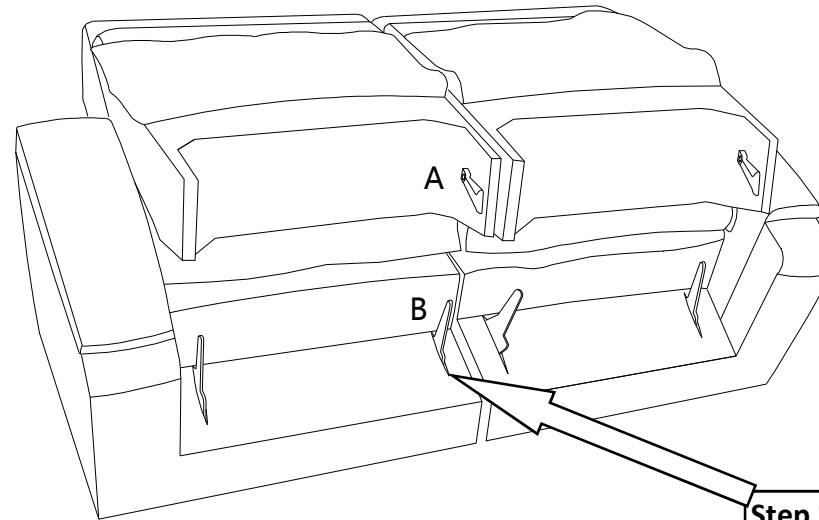

**Step 2**

Slide the metal receiver over the metal post. Press both sides of back firmly downward until locked in place.

**Step 3**

Insert the male KD Bracket into the slot of the female Bracket pressing firmly downward until the frame is tight.

