

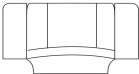

## LIST OF PARTS

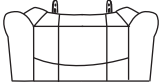

TOOLS REQUIRED:NO TOOLS REQUIRED			
PART LIST			
NO	Description	Item	Quantity
A	Backrest		1
B	Seat		1
C	LSF Top Arm Pad		1
D	RSF Top Arm Pad		1

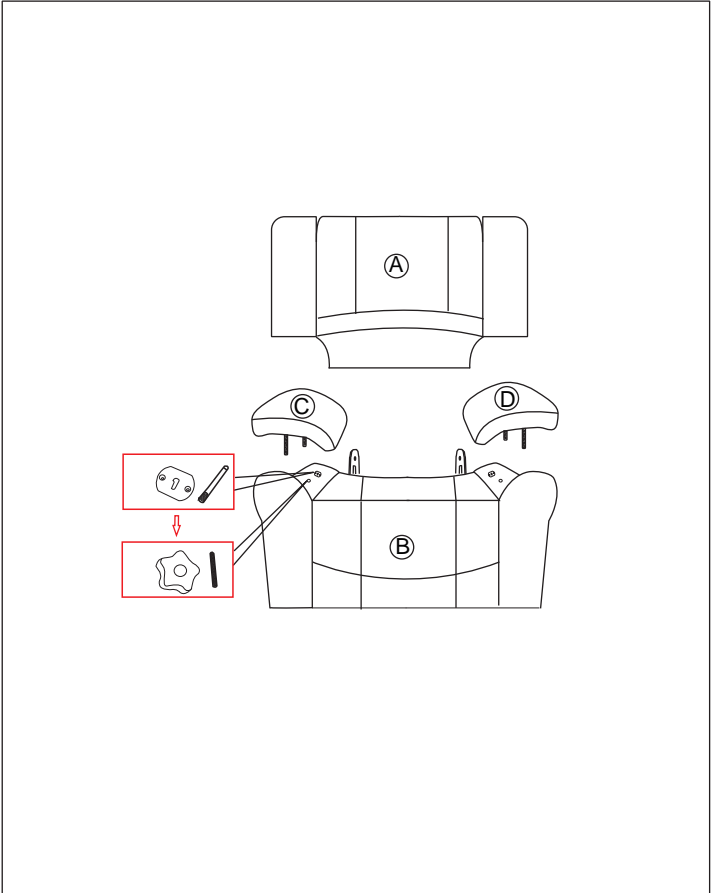

# LIST OF PARTS

TOOLS REQUIRED:NO TOOLS REQUIRED

## PART LIST

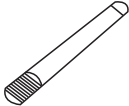
NO	Description	Item	Quantity
E	Front threaded rod 8mm*80mm		2
F	Plastic Nut		2
G	Back threaded insert 8mm*70mm		2

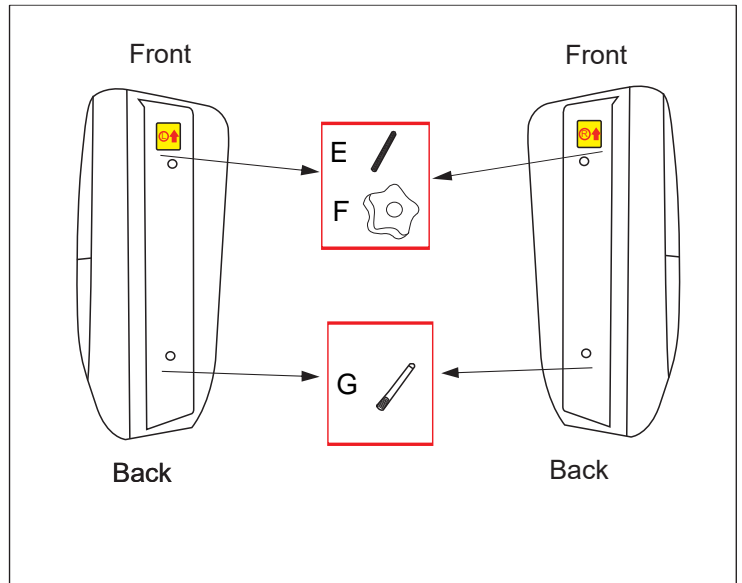

# ASSEMBLY INSTRUCTIONS

## STEP 1. Install the LSF Top Arm pad and RSF Top Arm pad

- Insert the Front threaded rod (E) on the front hole of Arm, the Back threaded insert (G) lock on the back hole of Top Arm.
  - Position the Top Arm pad into the Arm.
  - Lock the Plastic Nut(F) to the Front threaded rod(E) from the bottom of the Arm.
- Install the LSF Top Arm pad (C) and RSF Top Arm pad (D) in the same process.

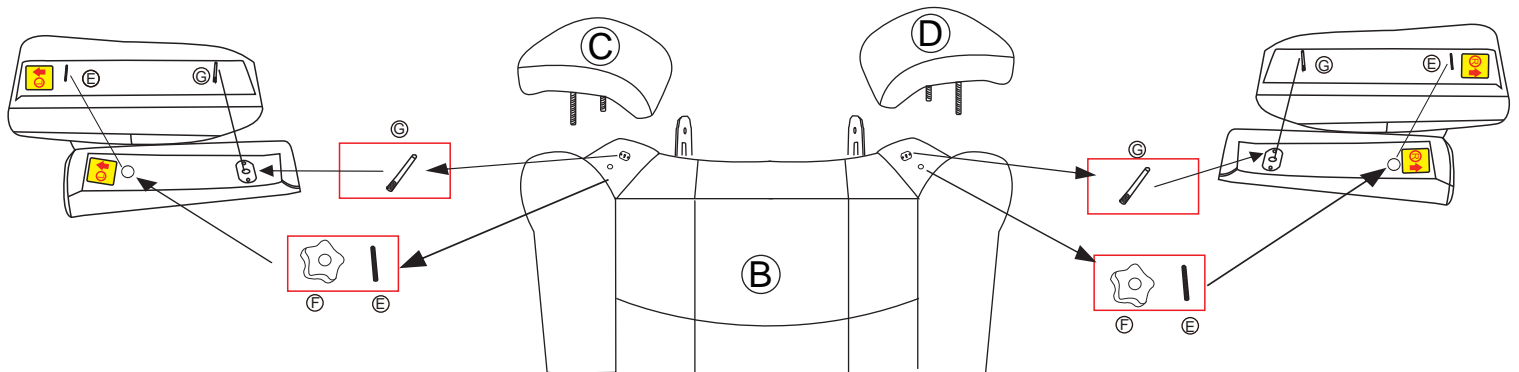

## STEP 2. Attaching the KD Backs

Position the back of Glider Recliner with the KD connectors positioned over the mechanism. Check to assure the mechanism are positioned inside of the KD connectors on the back frame, pushing in a downward motion from the top of the back frame until a clicking sound is heard.

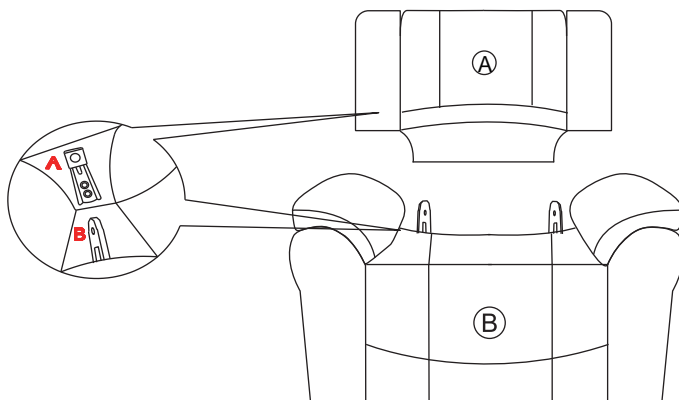

## MANUAL CONTROLS

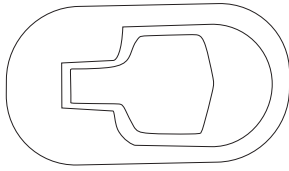

Pull the Manual handle.

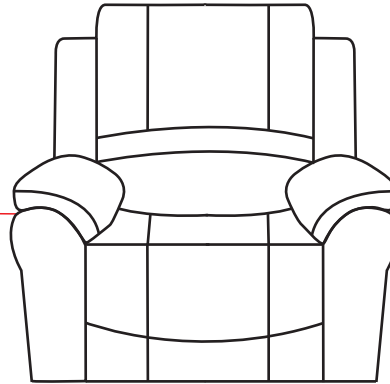

## WARNINGS

\*Keep unit at least 24" from all heat sources.

\*Avoid placing unit in areas where unit can be exposed to direct sunlight other powerful light sources, as fading or discoloration may occur.

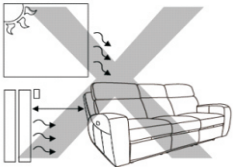

\*Do not reach under seat when mechanism is operating or serious injury may occur.

\*Reclining mechanism should only be operated while seated properly.

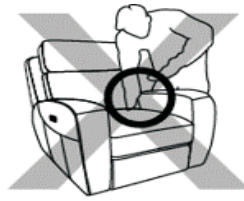

\*Do not sit on arms or backrest.

\*Do not jump or roughhouse on furniture.

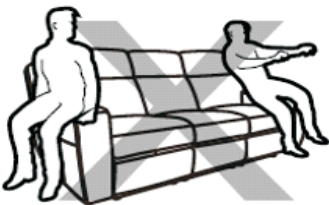

\*If unit must be moved, do not drag. Unit must be lifted in order to be moved.

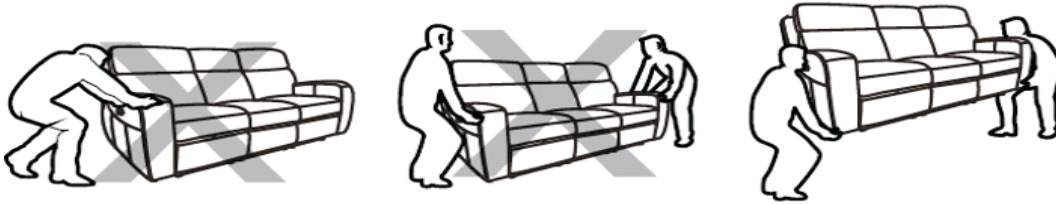

\*Do not continuously operate mechanism for more than one minute or unit may go into protection mode by shutting down to prevent overheating.

\*Unplug unit from power source prior to cleaning mechanism.

\*Do not allow electrical components to come into contact with any liquids.

## CARE AND CLEANING

\*Upholstered furniture is packaged tightly to protect it during transit. This packaging can sometimes cause creases or misshaped cushions when the furniture comes out of the packaging. These issues will correct themselves over time as the fibers of the cushions are exposed to air. However, shaping the cushions with your hands can alleviate the creases and compressed fibers more quickly.



Before shaping



After shaping



\*Dust often and use a vacuum cleaner to remove debris from seams and crevasses.

\*Use a soft damp cloth to gently clean soiled areas and wipe clean. Do not rub.

\*Do not use household cleaners or solvents. Such cleaners may cause damage and/or discoloration.

\*Do regularly use dedicated leather care product onto the leather furniture to prevent built up of body oils.