

Stage 1. Fitting the Unit

3 seat

1. Insert the Back Cushion onto the unit.
2. Carefully align the two side Metal Locks. Ensure they align correctly.
3. Engage the Metal Locks and push fit. You should hear them lock into position.
4. Locate the Velcro on the flap of the Back Cushions onto the back of Seat Cushions.

See Fig. 5

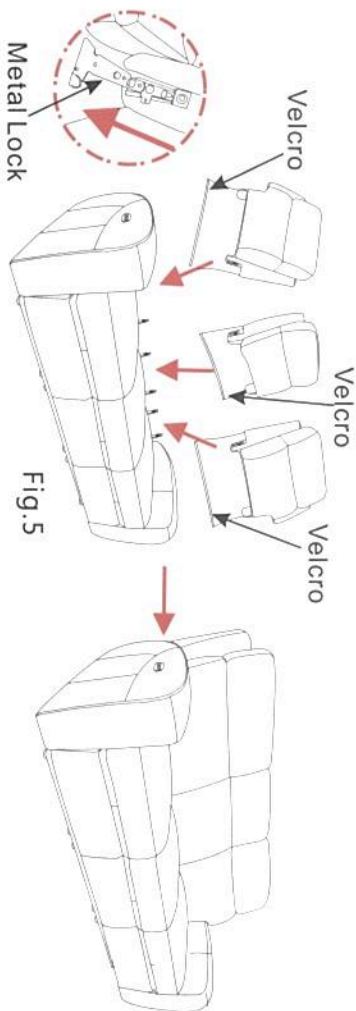

Stage 2. Fitting the Unit

NOTE: If the sofa doesn't have a head function, please ignore the following steps.

Remove the velcro behind the arm-seat. Align the two power lines and ensure they are connected. (See Fig.6)

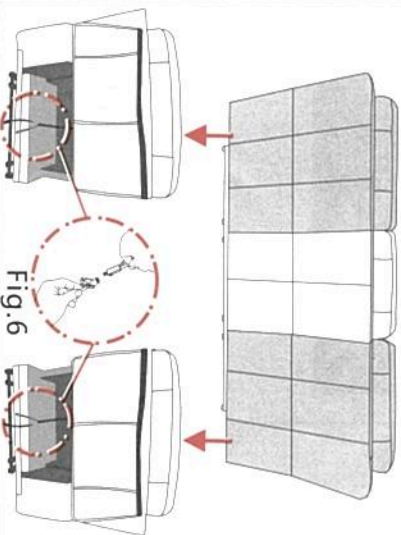

Finally
Complete the installation
Adjust the mechanism
with the button.

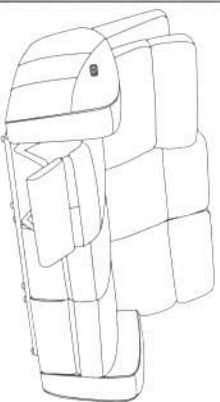

INSTALLATION INSTRUCTIONS

Stage 1. Fitting the Unit

Section

1. Insert the Back Cushion onto the unit.
2. Carefully align the two side Metal Locks. Ensure they align correctly.
3. Engage the Metal Locks and push fit. You should hear them lock into position.
4. Locate the Velcro on the flap of the Back Cushions onto the back of Seat Cushions.

See Fig. 7

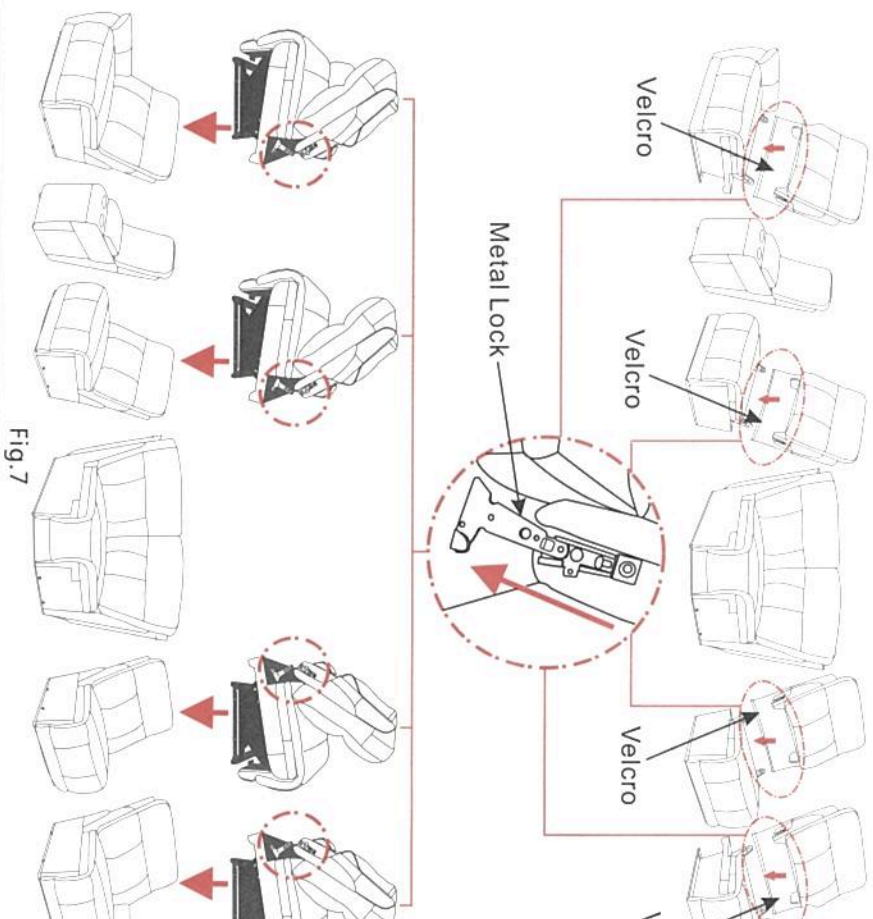

INSTALLATION INSTRUCTIONS

Stage 1. Fitting the Unit

Chair

1. Insert the Back Cushion onto the unit.
2. Carefully align the two side Metal Locks. Ensure they align correctly.
3. Engage the Metal Locks and push fit. You should hear them lock into position.
4. Locate the Velcro on the flap of the Back Cushions onto the back of Seat Cushions.
See Fig. 1

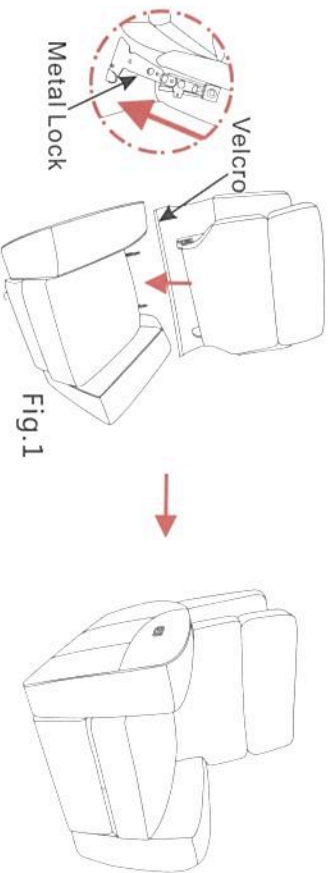

Stage 2. Fitting the Unit

NOTE: If the sofa doesn't have a head function, please ignore the following steps.

Remove the velcro behind the arm-seat. Align the two power lines and ensure they are connected. (See Fig.2)

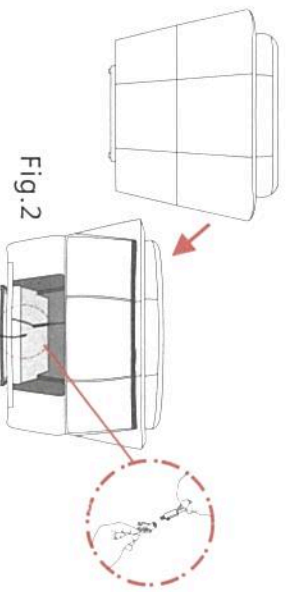

Finally
Complete the installation
Adjust the mechanism
with the button.



Stage 1. Fitting the Unit

2 se

1. Insert the Back Cushion onto the unit.
2. Carefully align the two side Metal Locks. Ensure they align correctly.
3. Engage the Metal Locks and push fit. You should hear them lock into position.
4. Locate the Velcro on the flap of the Back Cushions onto the back of Seat Cushions.
See Fig. 3

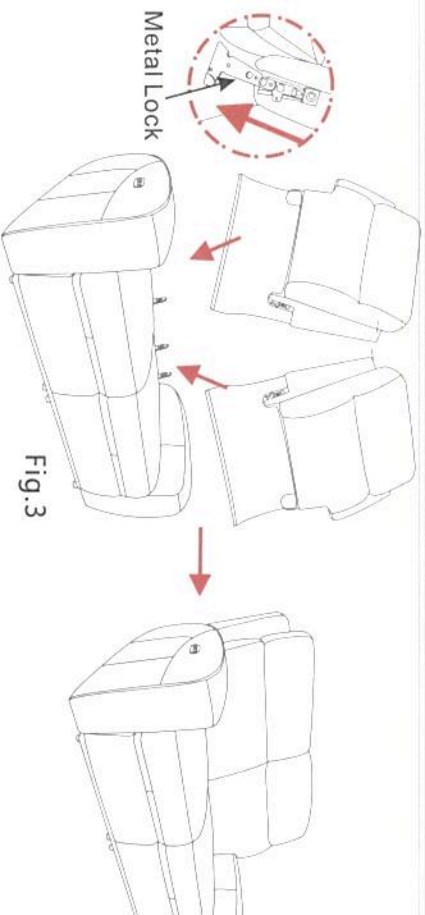

Stage 2. Fitting the Unit

NOTE: If the sofa doesn't have a head function, please ignore the following steps.

Remove the velcro behind the arm-seat. Align the two power lines and ensure they are connected. (See Fig.4)

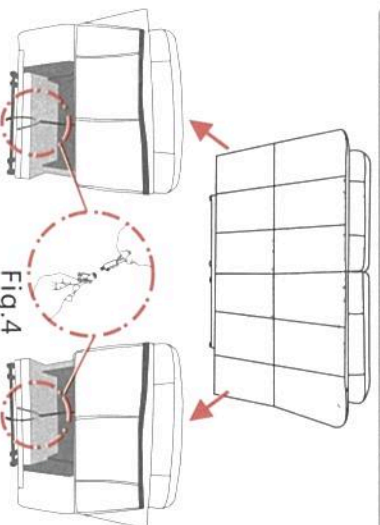

Finally
Complete the installat
Adjust the mechanism
with the button.



Please read the below information carefully before installing and using the product. Always operate the base according to these user guidelines.

Please ensure you connect the base properly to the power supply. We recommend using a surge protector (not included). Incorrect power connection may cause electric shock or fire.

Before plugging into the wall check to ensure that there are no cords wound around the mechanism underneath the suite.

Matters needing attention

- The following parts need to be installed to some sofas, please follow the following steps during installation.

Arm Cushion Installation

- Arm cushions of some sofas will be placed in the bottom of the arm bases.
- Take the arm cushion out of arm base bottom (Fig. 10).
- And then rotate the two screws clockwise into the screw holes on the bottom of arm cushion (Fig.11).
- Insert the screws into drilling holes. (Fig.12);
- Use butterfly nut to fasten the two mentioned screws from the internal of the arm base (Fig. 13).

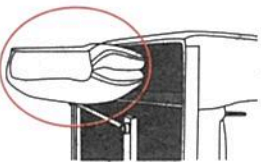

Fig.10

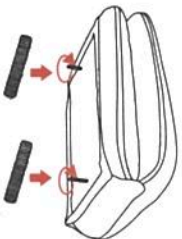

Fig.11

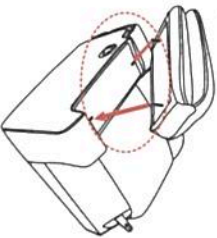

Fig.12

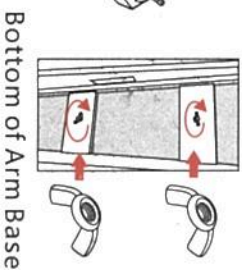
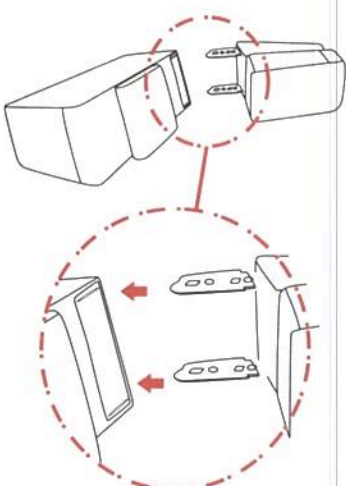
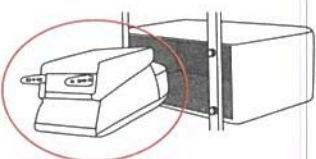

Fig.13

Bottom of Arm Base

Console Back Installation

- Some console backs will be placed in the bottom of console bases.
- Take the console back out of the bottom of the console base. Aim the back plug at the slot and push fit.



Back ear installation

- Some sofas are with back ears which need to be installed. Normally these ears are placed at the back of the sofa.
- Put the back ear against the back and push the plug into the slot

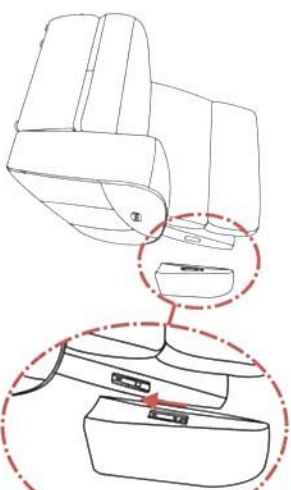
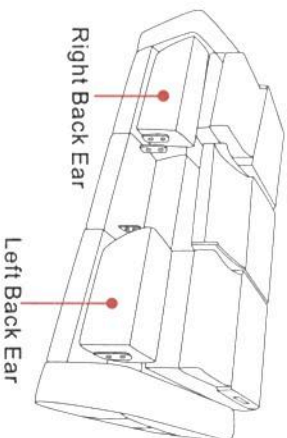

Stage 2. Fitting the Unit

NOTE: If the sofa doesn't have a head function, please ignore the following steps.

Remove the velcro behind the arm-seat. Align the two power lines and ensure they are connected. (See Fig.8)

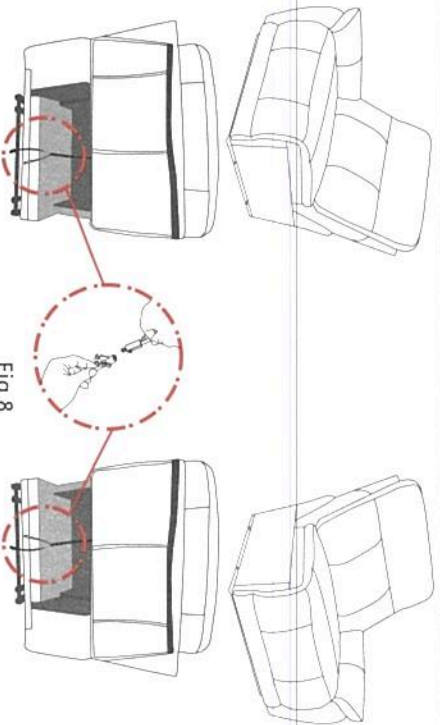

Stage 3. Fitting the Unit

Install the various parts of the sofa according to the arrow pointing and numbering sequence.
Carefully align connecting hooks&holes into position and lock them to secure the mechanism. (See Fig.9)

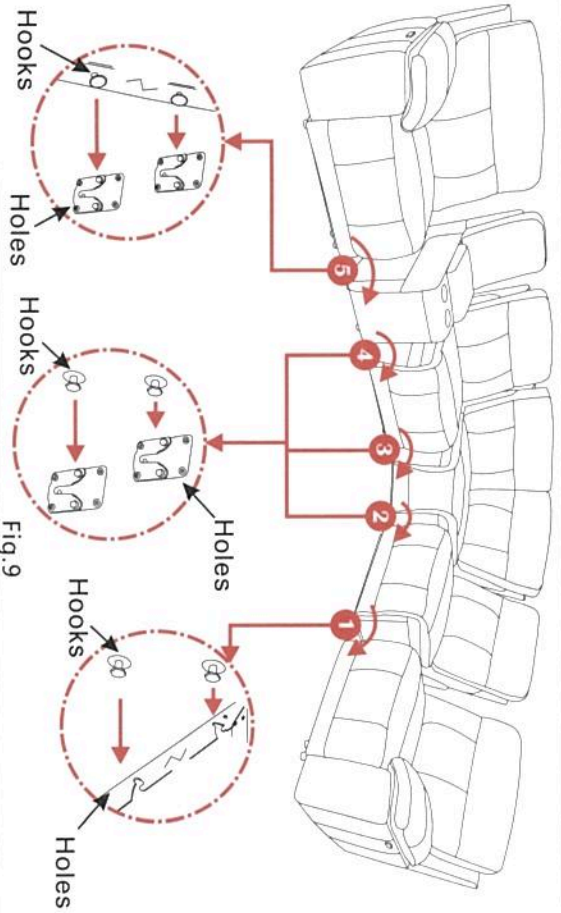

Complete

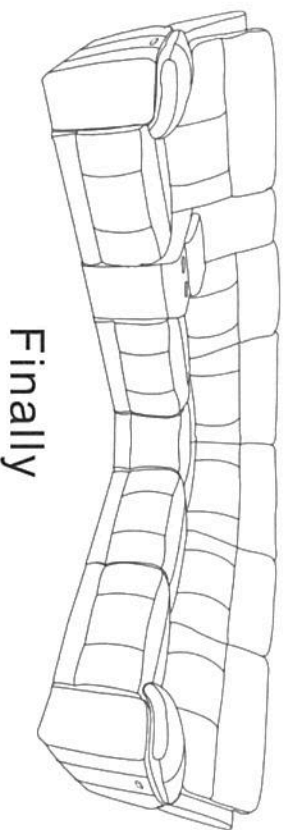

Finally

Complete the installation
Adjust the mechanism
with the button.

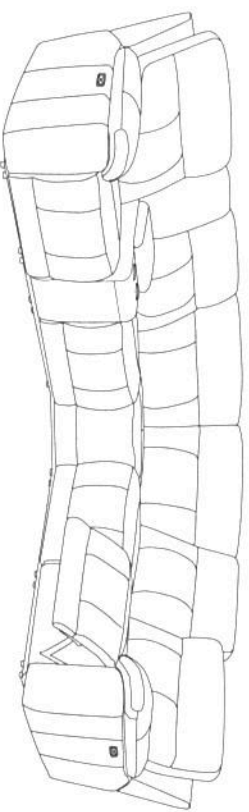

Use and maintenance

- The sofa requires no special but normal maintenance, so does the padding material.
- If your sofa is with fabric filler or down feather padding, you will need to shape its cushions carefully to make them restore to their original shapes, because long way transportation will make the cushions out of shape.
- In fact, the long journey which the sofa is subjected to before reaching your home could temporarily affect the sofa's initial beauty.

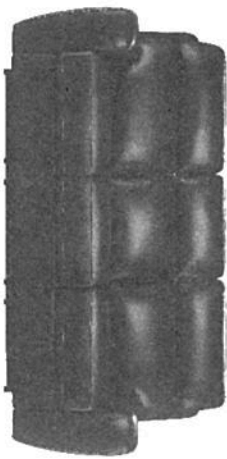
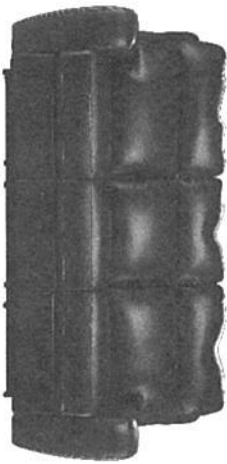

Before shaping

After shaping

