

SFU-9159(L2P+RSCCH)

PARTS LIST:

- A:  8 PCS
- B:  WOOD SCREWS 40 PCS
- C:  STRAIGHT LEG 3 PCS

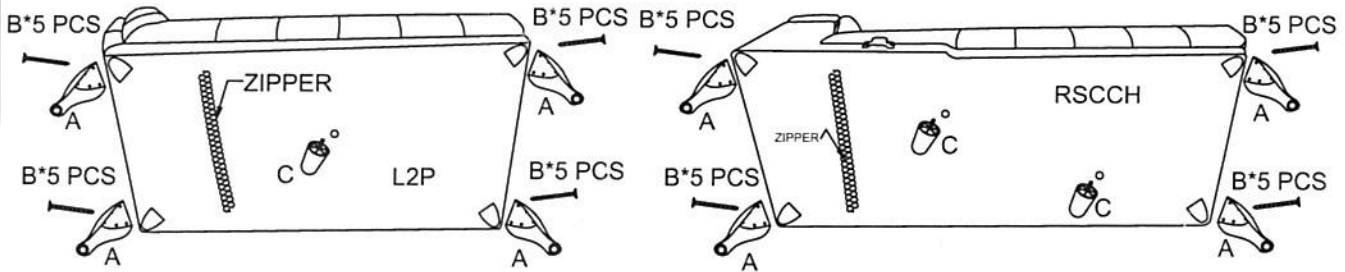
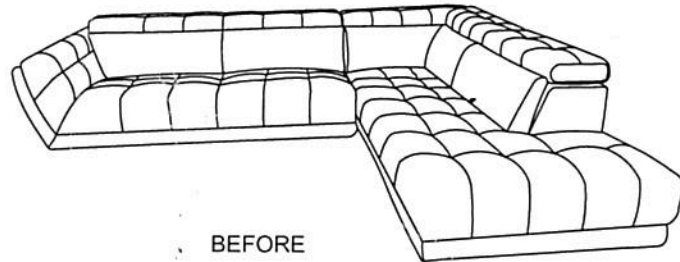

NOTES

1. UNZIP, WHERE SOFA LEGS AND SCREWS ARE KEPT.
2. CONFIRM THE SOFA LEGS AND SCREWS ARE IN LINE WITH THE LIST ON TOP LEFT PICTURE.
3. ALIGN THE LEGS TO THE MARKED POSITION ON BOTTOM OF SOFA. REFER TO PICTURE.
4. PLEASE USE FIVE SCREWS (B) WHEN FASTENING EACH LEG (A), STRAIGHT LEG (C) NEED BE SCREWED THROUGH MIDDLE HOLE.
5. DISPLAY AS BELOW PICTURE AFTER FINISHING INSTALLATION, CHECKING IF CORRECT AND FIRM FOR THE SOFA LEG INSTALLATION. FINALLY, USE THE CONNECTOR TO CONNECT LAF SOFA WITH RAF CORNER STORAGE CHAISE.

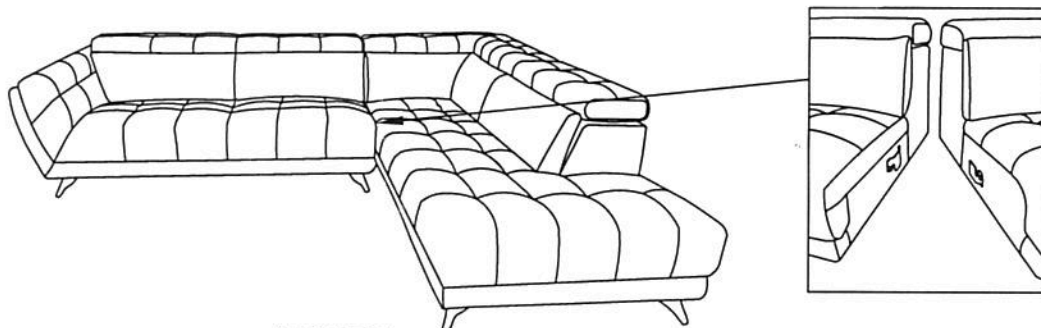

AFTER

MARS SFU-9159 OT

PARTS LIST:

A:  LEGS 4 PCS

B:  WOOD SCREWS 20 PCS

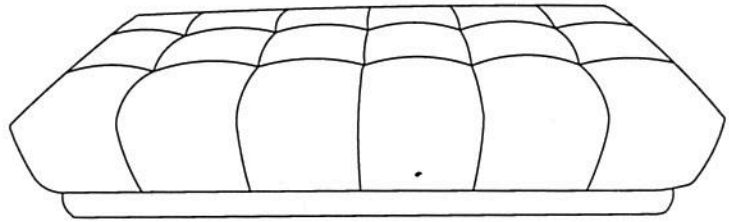

BEFORE

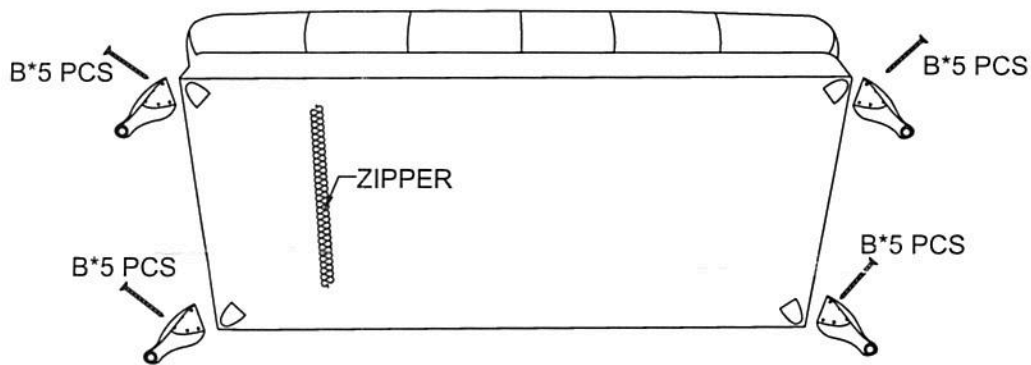

NOTES

1. UNZIP, WHERE SOFA LEGS AND SCREWS ARE KEPT.
2. ALIGN THE LEGS TO THE MARKED POSITION ON THE BOTTOM OF OTTOMAN. REFER TO PICTURE .
3. PLEASE USE A POWER SCREW DRIVER WHEN FASTENING LEGS.
4. HOLES ARE NOT PRE-DRILLED TO ENSURE TIGHTER FIT OF SELF -THREADING WOOD SCREWS.

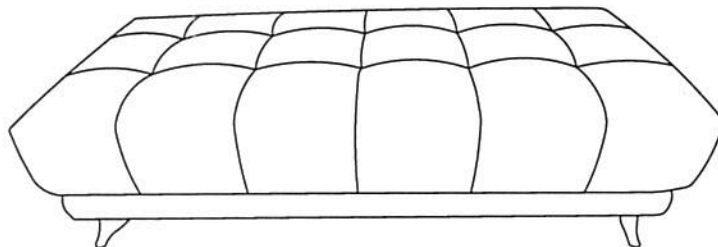





AFTER

ZOEY-CHAIR

SFU-9116 (1P)

PARTS LIST:

- A:  SQUARE BASE 1 PCS
B:  ROUND BASE 1 PCS (LARGE)
C:  SCREW 4 PCS
D:  WASHER 4 PCS
E:  HEX KEY 1 PCS

ALL HARDWARE PACKAGED WITH ROUND BASE

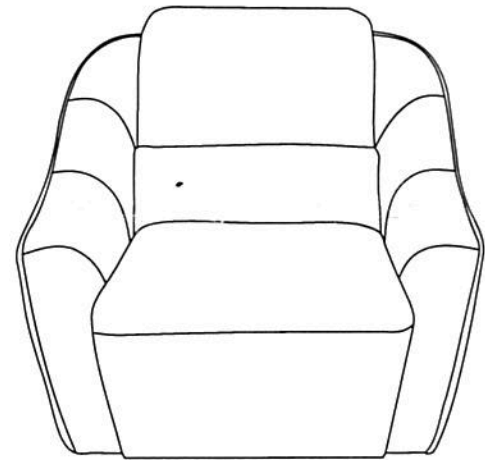

BEFORE

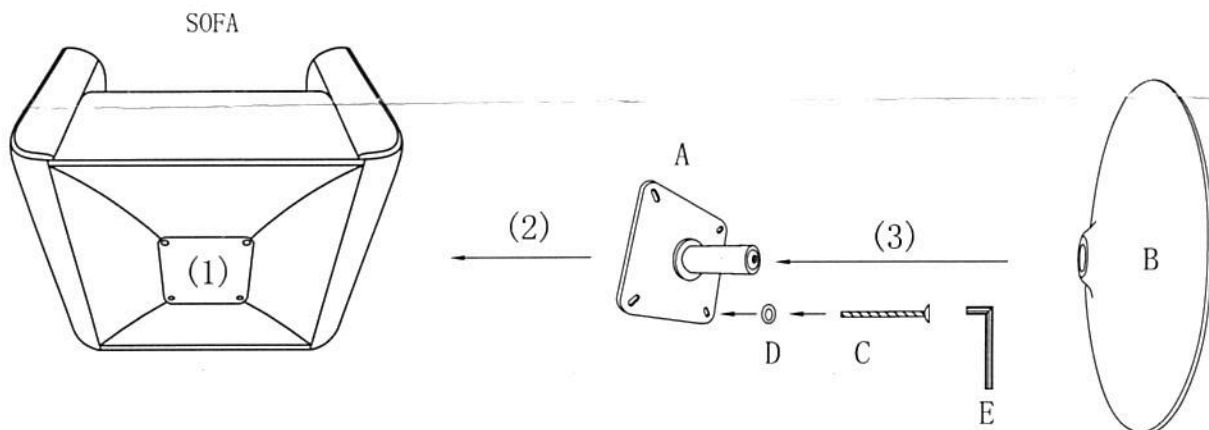

- ① REMOVE <A> SQUARE BASE AND TURN UPRIGHT.
- ② ATTACH SQUARE BASE ABOVE WITH SCREWS AS SHOWN ABOVE.
- ③ ATTACH ROUND BASE TO SQUARE BASE, PUSH DOWN FIRMLY TO ATTACH ROUND BASE
- ④ CAREFULLY TURN CHAIR UPRIGHT.
- ⑤ SEATING ON CHAIR IS NEEDED TO COMPLETE ATTACHMENT OF ROUND BASE TO SQUARE BASE.

