







ASSEMBLY INSTRUCTION

Arianna accent chair

Parts#	Parts Name	Drawing	Qty
A	Front Legs		2
B	Back Legs		2
C	Chair		1
D	Bolt		8
E	Spring Washer		8
F	Flat Washer		8
H	Allen Wrench		1

Step 1. Remove the non-woven cover at bottom of the chair and take out the legs.

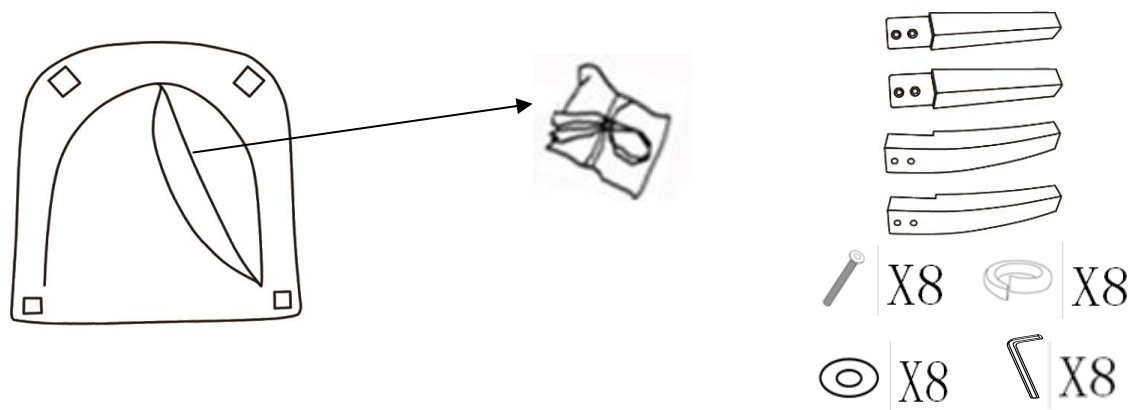

Step 2: Insert the front legs (A) and back legs (B) to seat frame, lock legs by using spring washer (E), flat washer (F), bolt (D), Then tighten the bolts with allen wrench (H).

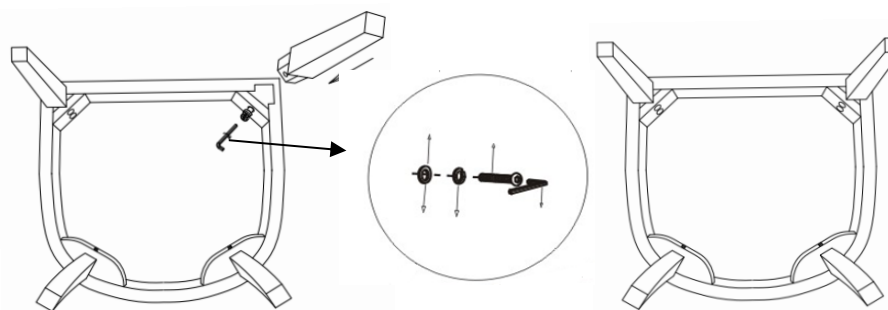

Step 3: Turn the chair over and place it upright on a level surface.

