

# ASSEMBLY INSTRUCTIONS

Description: Accent Chair





## Important safety instructions:

- Please carefully read all instructions before assembling the chair.
- For your safety and ease, assembly by two or more adults is recommended.
- Keep instructions for future use.

## Pre-assembly:

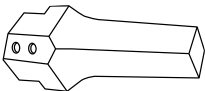
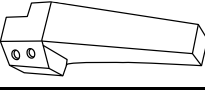
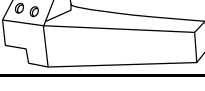

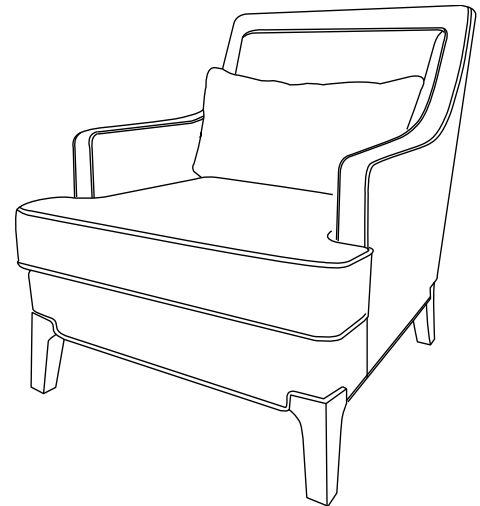

- Do not discard any contents until after assembly is complete to avoid accidentally discarding small parts or hardware.
- Remove all parts and hardware from box along with any plastic protective packaging.

## Parts List

Item	Description		Qty
A	Wood front legs		2
B1	Wood right back legs		1
B2	Wood left back legs		1
C	Chair		1
D	Seat Cushion		1
E	Pillow		1



## Hardware List

a	Allen wrench		1
b	Flat Washer		8
c	Bolt(size:70*8mm)		8
d	Spring washer		8

## Assembly Procedures:

Step 1. Turn the chair upside down and lay on protective carpet, Open the black fabric of the bottom, and take out the legs underneath the seat.

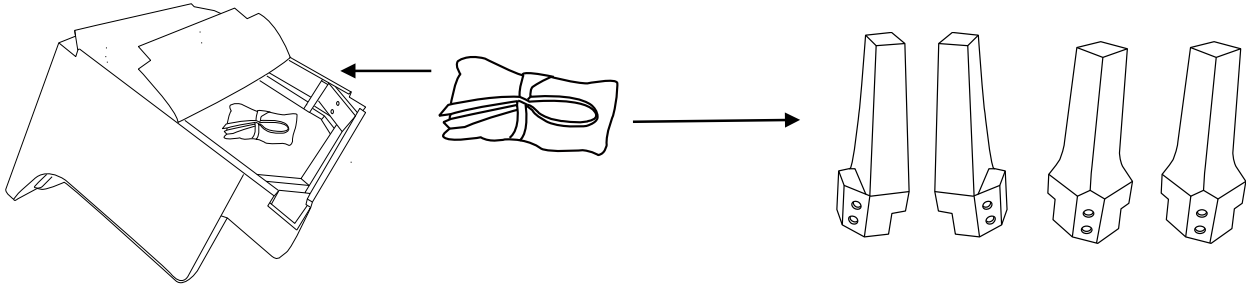

Step 2. Attach the chair legs (A、 B1、 B2) to seat frame, insert the bolts (c) and spring washer(d) and flat washers (b). Then tighten the bolts with allen wrench (a).

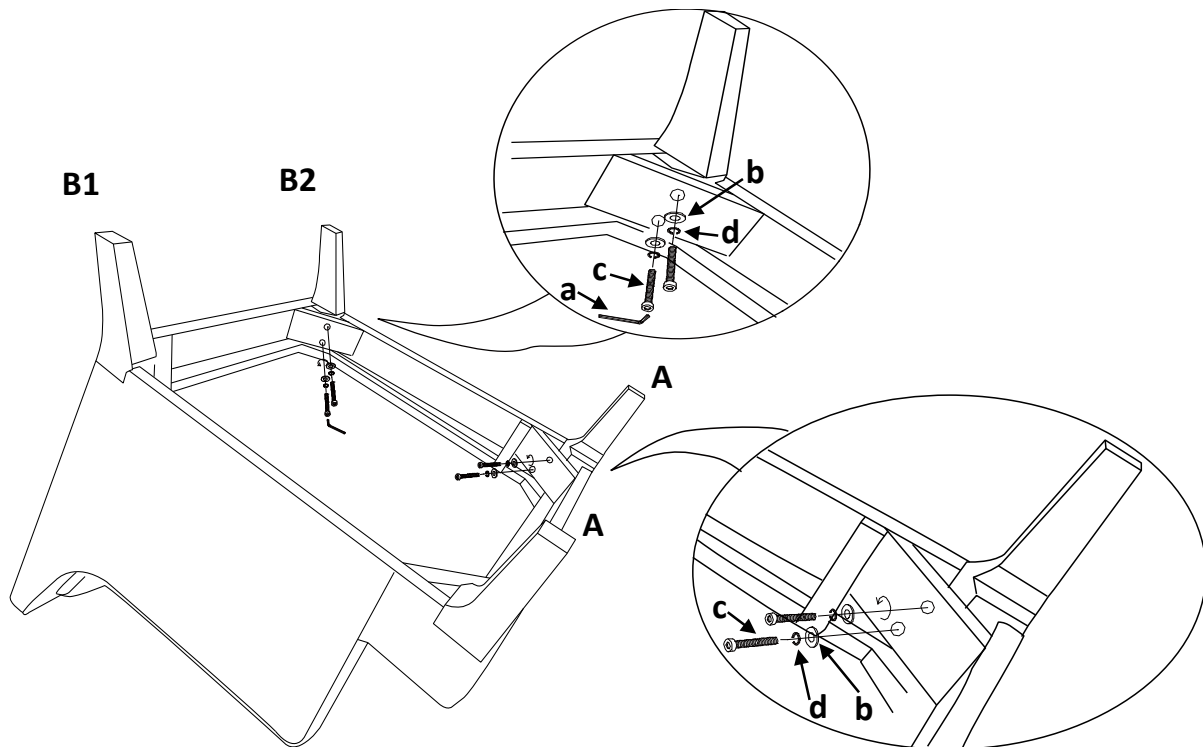

Step 3. Close the black fabric of the bottom, turn the chair over, place the cushion and the pillow on the chair.

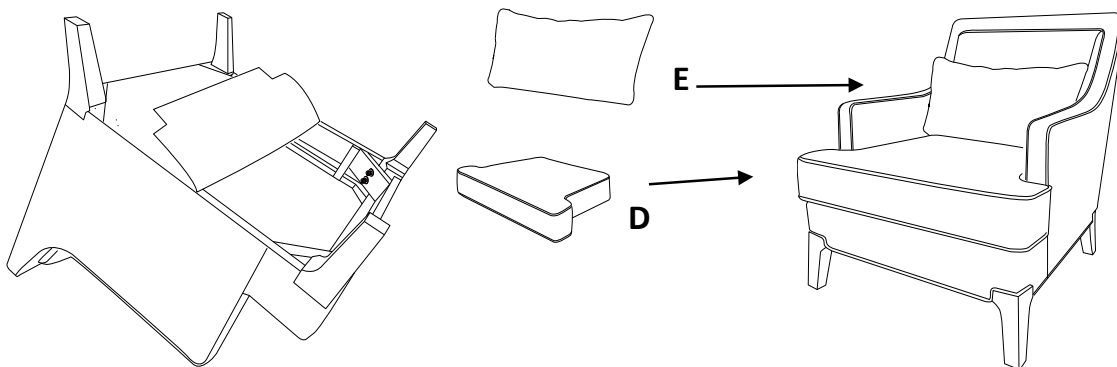

**ADDITIONAL NOTE ABOUT SAFETY: BOLTS MAY LOOSEN DURING NORMAL EVERYDAY USE, THEY SHOULD BE PERIODICALLY INSPECTED AND RE-TIGHTENED TO PREVENT DAMAGE OR INJURY. ALWAYS CHECK TO BE SURE THAT ALL HARDWARE IS KEPT TIGHTENED.**

## **USE AND CARE INSTRUCTIONS FOR YOUR MADISON PARK SIGNATURE FURNITURE**

- Your wood furniture can be cleaned using a damp soft cotton cloth to wipe it down, then wipe dry ...  
a second soft cotton cloth.
- Some spray and liquid furniture polishes can change the sheen (how shiny your furniture is) of the finish. If you plan to use a product like this to clean your furniture you should first test it in an inconspicuous part of the furniture.
- Upholstery should be cleaned using a quality product intended for furniture upholstery.
- It is best to not place your furniture in direct sunlight as it can fade the finish or fabric over time.
- Always lift your furniture when moving it as dragging it can cause damage.