







Important safety instructions:

- Please read carefully all instructions before assembling the table.
- For your safety and ease, assembly by two or more adults is recommended.
- Keep instructions for future use.









Pre-assembly:

- Do not discard any content until assembly completed to avoid accidentally discarding small parts or hardware.
- Take out all parts and hardwares from box .

Parts List

Item	Description	DRAWING	QTY
P1	Front Legs		2
P2	Right Back Leg		1
P3	Left Back Leg		1
P4	Left Wing		1
P5	Right Wing		1
P6	Backrest		1
P7	Chair Seat		1

Hardware List

Item	Description	DRAWING	QTY
H1	Plastic Washer		2
H2	Bolts φ5/16*1"		6
H3	Bolts φ4/16*1-9/16"		2
H4	Lock Washers φ5/16"		6
H5	Flat Washers φ4/16"		2
H6	Flat Washers φ5/16"		6
H7	Allen Wrench φ4/16"		1
H8	Allen Wrench φ5/16"		1

Step 1. Assemble the chair on a flat, soft surface such as carpet or cloth to prevent scratching the finish. Take out four legs and hardware from the box which is in the seat. Then turn the chair seat upside down. Extend the Footrest to open and take out wings from inner box. Return the Footrest to original position.

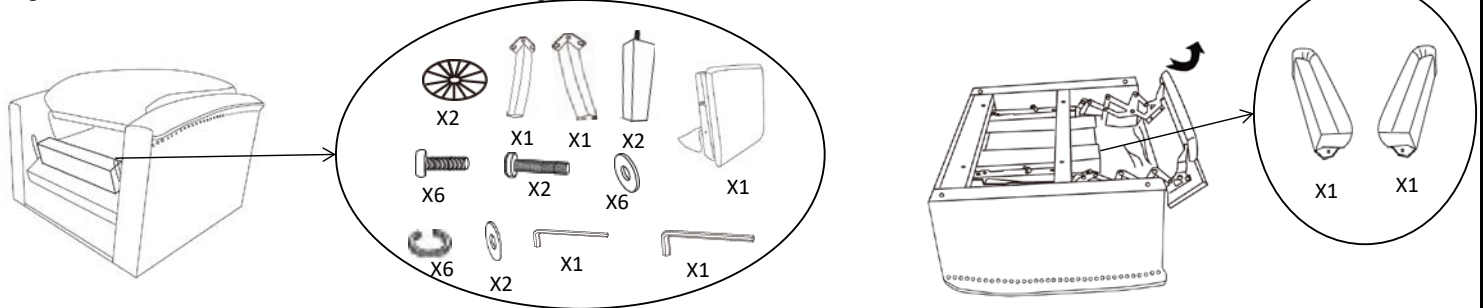

Step 2. Attach the front legs (P1) to chair seat (P7) with plastic washer (H1) by turning the legs clockwise. Using bolts (H2), lock washers (H4), flat washers (H6), attach back legs (P2,P3) to chair seat (P7). Tighten bolts (H2) with allen wrench (H8).

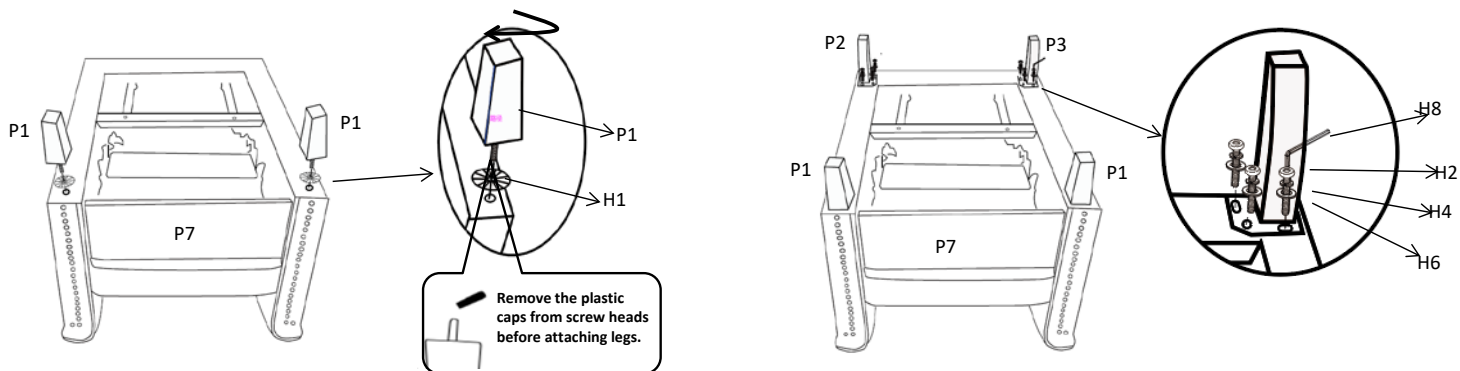

Step 3. Attach wings (P4&P5) to the backrest (P6) using bolts (H3) and flat washer (H5) with allen wrench (H7). Fully tighten them until secure. See insert diagram as below.

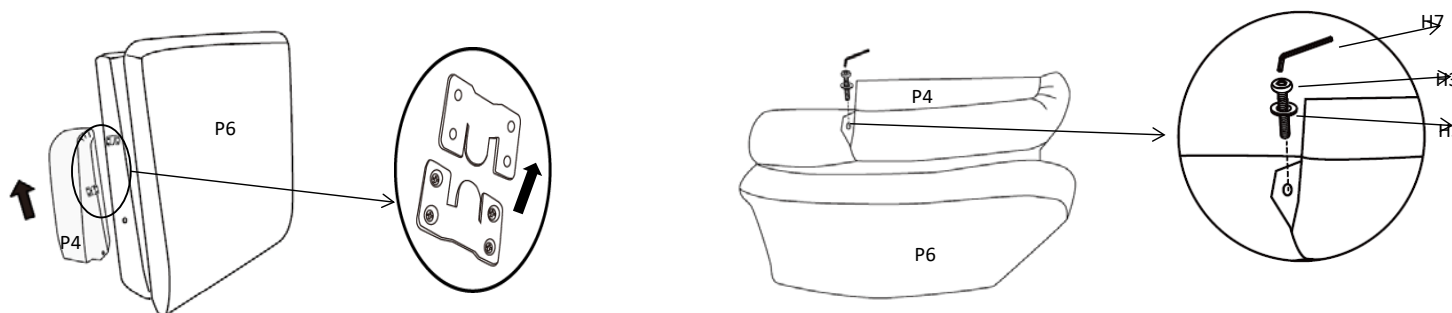

Step 4. Align female metal bracket located on the sides of the chair backrest (P6) with the prefabricated slide lock gadget on the chair seat (P7), Insert the small metal arms and push down to lock it (as shown below).

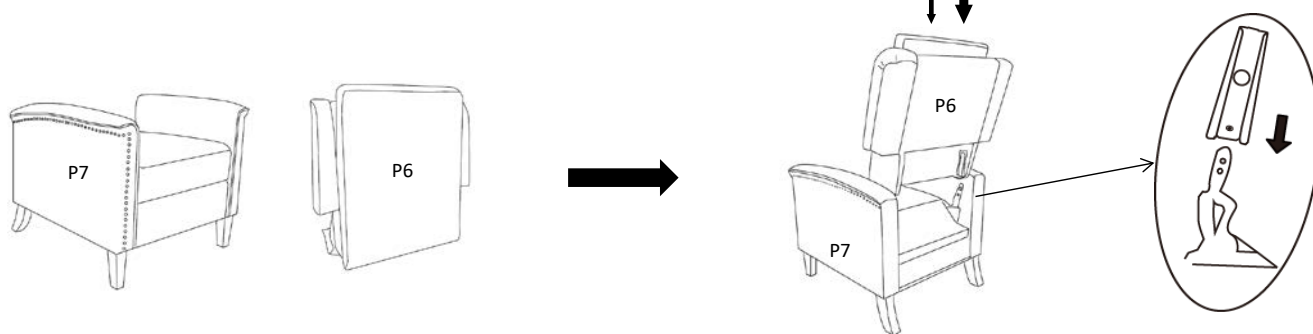

Step 5. Smoothly pat down the fabric on the chair backrest (P6) on both sides of the flap from top to bottom, allowing the velcro tape to adhere to the flap under the seat of the chair. Assembly is complete.



ADDITIONAL NOTE ABOUT SAFETY: BOLTS MAY LOOSEN DURING NORMAL EVERYDAY USE. THEY SHOULD BE PERIODICALLY INSPECTED AND RE-TIGHTENED TO PREVENT DAMAGE OR INJURY. ALWAYS CHECK TO ENSURE THAT ALL HARDWARE IS KEPT TIGHTENED.

Thank you for your purchase