



INSTRUCTIONS D'ASSEMBLAGE
ASSEMBLY INSTRUCTIONS

MONARCH
SPECIALTIES INC.

I 3477

TABLE D'APPOINT -
25"H / NOIR / METAL NOIR

ACCENT TABLE -
25"H / BLACK / BLACK METAL





POUR DE L'ASSISTANCE OU POUR COMMANDER
DES PIÈCES CONTACTEZ NOTRE DÉPARTEMENT
DE SERVICE À LA CLIENTÈLE.

FOR ASSISTANCE OR TO ORDER PARTS
CONTACT OUR CUSTOMER SERVICE DEPARTMENT

WWW.MONARCHSERVICE.COM

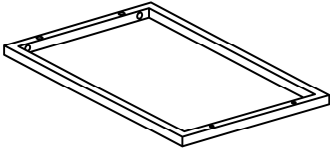
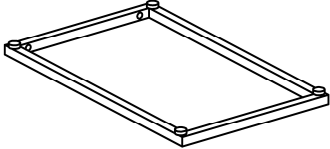
LISTE DES PIÈCES
PARTS LIST

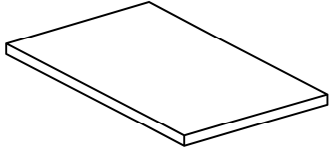
PIÈCE / PART #	IMAGE	DESCRIPTION	QTY / QTÉ
1		BACK FRAME CADRE DU DOSSIER	1
2		TOP FRAME CADRE DE SURFACE	1
3		BOTTOM FRAME CADRE DU BAS	1
4		SUPPORT BAR BARRE DE SOUTIEN	2
5		TABLE TOP SURFACE DE TABLE	1

LISTE DES PIÈCES DE MONTAGE
HARDWARE LIST

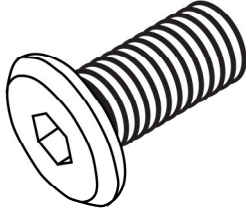
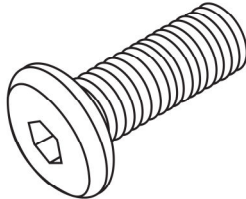
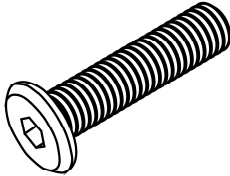
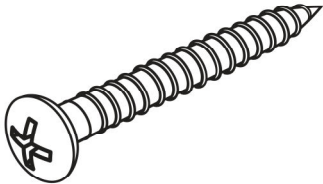
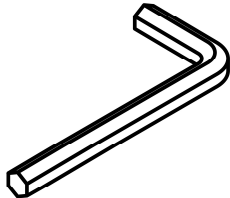
PIÈCE / PART #	IMAGE	DESCRIPTION	QTY / QTÉ
A		ASSEMBLING BOLT - Ø 1/4" X 3/4" BOULON D'ASSEMBLAGE - Ø 1/4" X 3/4"	4
B		ASSEMBLING BOLT - Ø 1/4" X 1" BOULON D'ASSEMBLAGE - Ø 1/4" X 1"	2
C		ASSEMBLING BOLT - Ø 1/4" X 1 1/8" BOULON D'ASSEMBLAGE - Ø 1/4" X 1 1/8"	6
D		ASSEMBLING SCREW - Ø 1/8" X 1" VIS D'ASSEMBLAGE - Ø 1/8" X 1"	2
E		HEX KEY CLÉ HEXAGONALE	1



OUTIL DE VÉRIFICATION DE DIMENSIONS DES PIÈCES
HARDWARE DIMENSIONS VERIFICATION TOOL

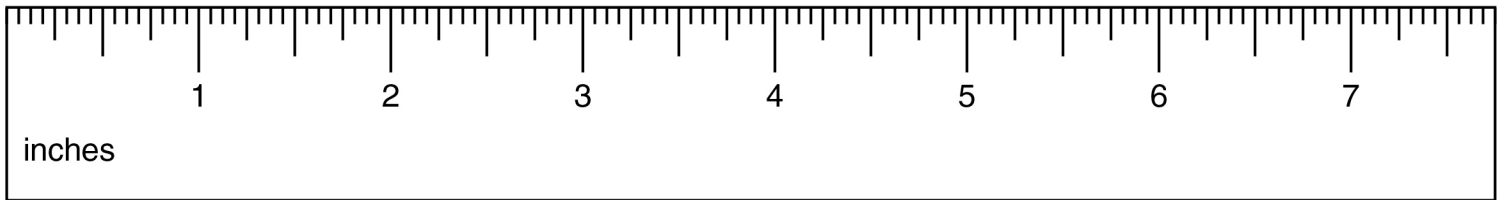

ÉTAPE / STEP 1

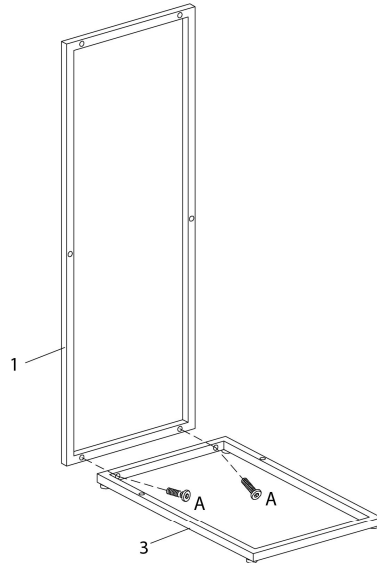

ÉTAPE / STEP 2

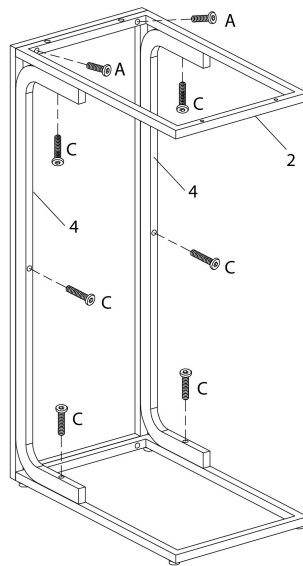

ÉTAPE / STEP 3

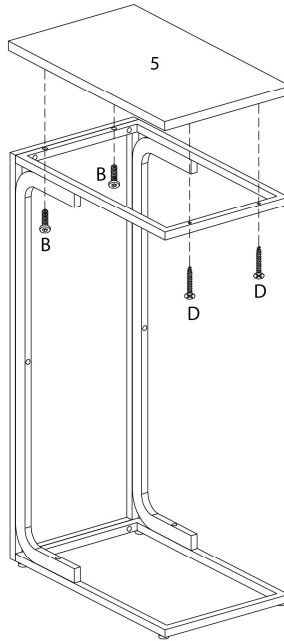

ÉTAPE / STEP 4

