

HOMEDOCK

MANUAL DE MONTAGEM

ASSEMBLY INSTRUCTIONS

INSTRUCCIONES DE MONTAJE

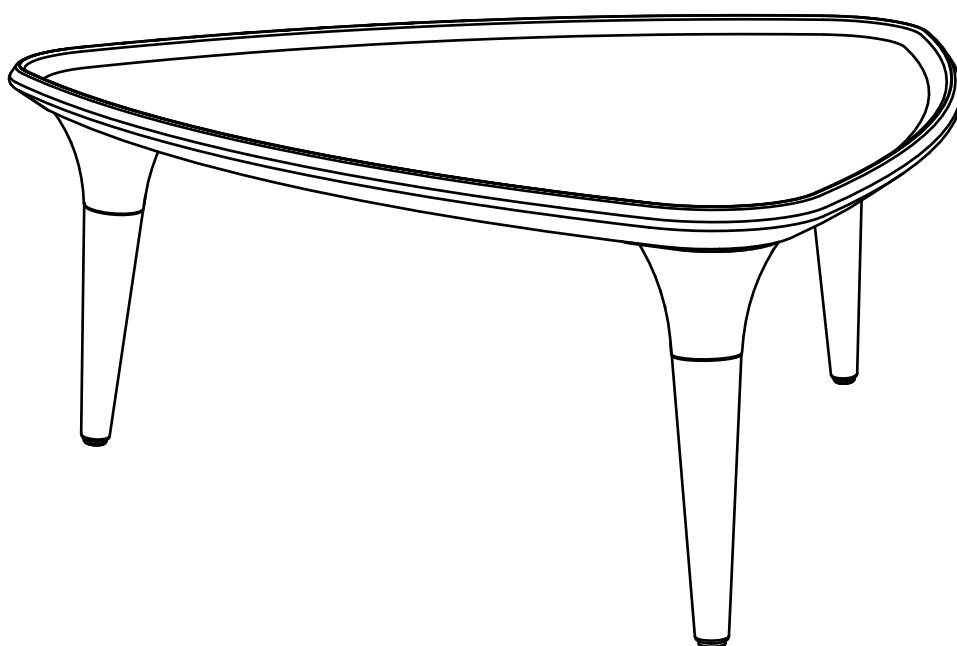

COD BR: 253400

REV. 01

OBSERVAÇÕES IMPORTANTES

IMPORTANT REMARKS

OBSERVACIONES IMPORTANTES



Nunca escale ou se apoie sobre o móvel. Você pode sofrer graves acidentes.

Never climb or lean on the furniture. You may suffer serious accidents.

Nunca escale o apoye sobre el mobiliario. Usted puede sufrir accidentes graves.

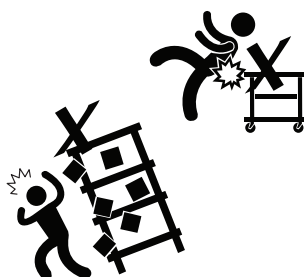

Utilize a embalagem para forrar a área de montagem e separar todas as peças.

Use the packaging to cover the assembly area and separate all parts.

Utilice el embalaje para cubrir la area de montaje y separe las piezas.

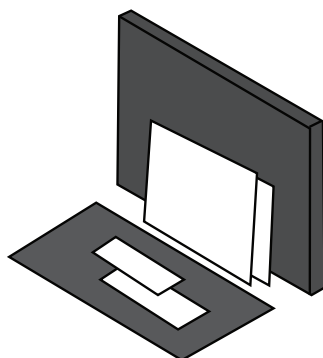

Observe os números impressos nas bordas para identificar as peças.

Identify the parts by observing the number printed on their edges.

Identifique las piezas observando el numero impreso en sus bordes.

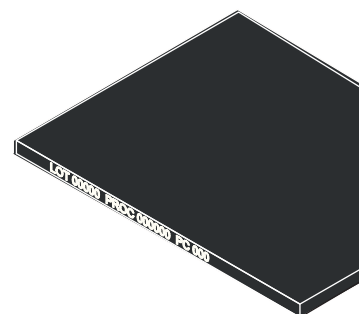

LIMPEZA E CONSERVAÇÃO
CARE INSTRUCTIONS
LIMPIEZA Y CONSERVACIÓN



Limpe com um pano limpo e umedecido em água e sabão neutro. Não utilizar produtos químicos e abrasivos.

Wipe clean using a damp cloth and a mild cleaner. Do not use abrasive and chemical products.

Limpie con un paño limpio humedecido con agua y jabón neutro. No utilice productos químicos y abrasivos



MOVIMENTAÇÃO
HANDLING
MOVIMIENTO

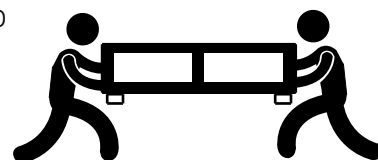

Movimente o móvel com cuidado, sem arrastar. Peça ajuda a outra pessoa para fazê-lo.

Move the piece carefully, don't drag it. Ask for someone else's help to do so.

Mover la unidad con cuidado, sin arrastrar. Pedir ayuda a otra persona para moverlo.

ACESSÓRIOS HARDWARE HERRAJES



Identifique e separe os acessórios utilizados.
Em cada embalagem, uma etiqueta identifica
as peças e onde utilizá-las.

Identify and separate the hardware used in
the assembly. There's a label on each package
identifying the parts and where to use them..

Identifique y separete los accesorios utilizados
en el montaje. Observe la etiqueta en cada
paquete para saber donde montar.

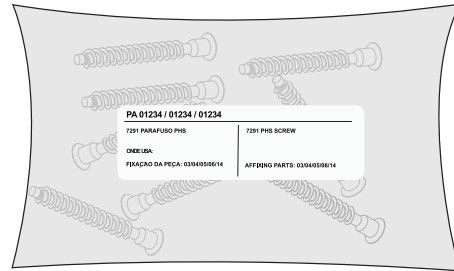

cod. 8056-3x



A

cod. 11198-3x



B

cod. 11065-3x

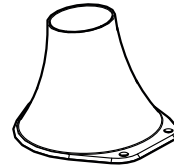

C

DESCRIÇÃO / DESCRIPTION / DESCRIPCIÓN

CÓD: 253400					
PEÇA PART PIEZA	QUANTIDADE QUANTITY CANTIDAD	DESCRIÇÃO	DESCRIPTION	DESCRIPCIÓN	BOX
01	01	TAMPO	TABLE TOP	CUBIERTA	1
62	03	PE MADEIRA PALITO	ANGLED WOOD LEG	PATAS INCLINADAS	1

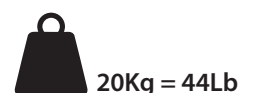
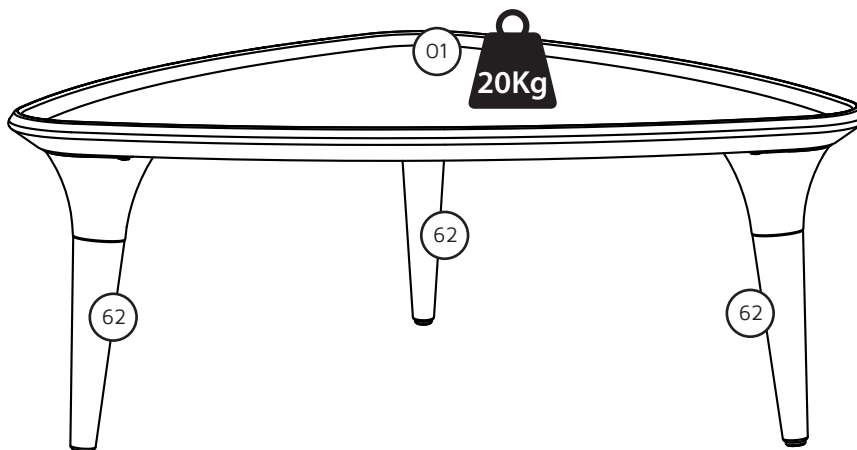

01

Atenção
Atención
Attention

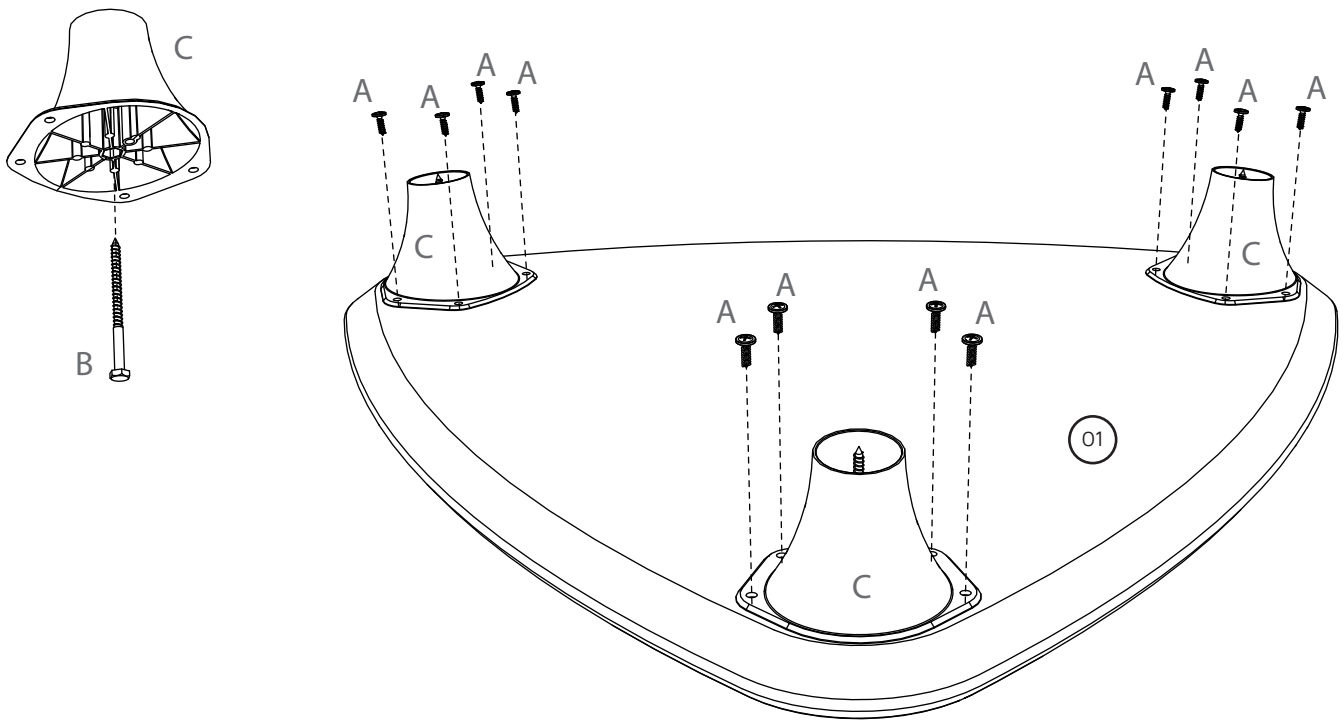
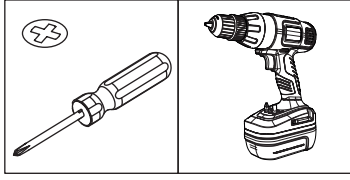

02

