









ASSEMBLY INSTRUCTIONS

ITEM NO: 60237&60242

Thank you for purchasing this quality product. Be sure to check all packing material carefully for small parts that may have come loose inside the carton during shipment. (Note: Loosely thread all screws/bolts first. Once the item is assembled then completely tighten.)

PARTS LIST				HARDWARE LIST				
NO.	Description	Sketch	Quantity	NO.	Description	Sketch	Size	Quantity
A	Top		1	D	Lock washer		$\Phi 1/5 \text{ " } * 1/50 \text{ "}$	8
B	Legs		2	E	Blots		$\Phi 7/25 \text{ " } * 8/5 \text{ "}$	6
				F	Blots		$\Phi 7/25 \text{ " } * 2 \text{ "}$	2
C	Board		1	G	Block Shot		$\Phi 3/5 \text{ "}$	2
				H	Allen wrench		$\Phi 1/5 \text{ "}$	1

STEP ONE:

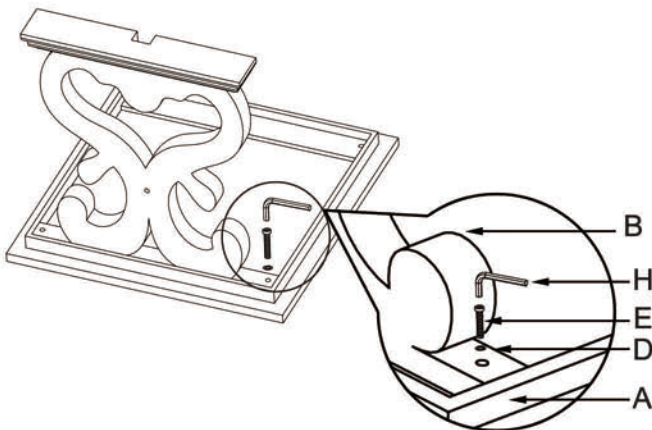

STEP TWO:

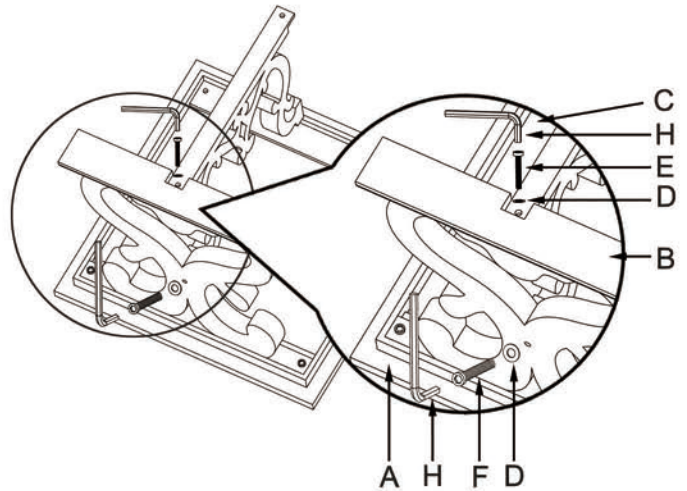

STEP THREE:

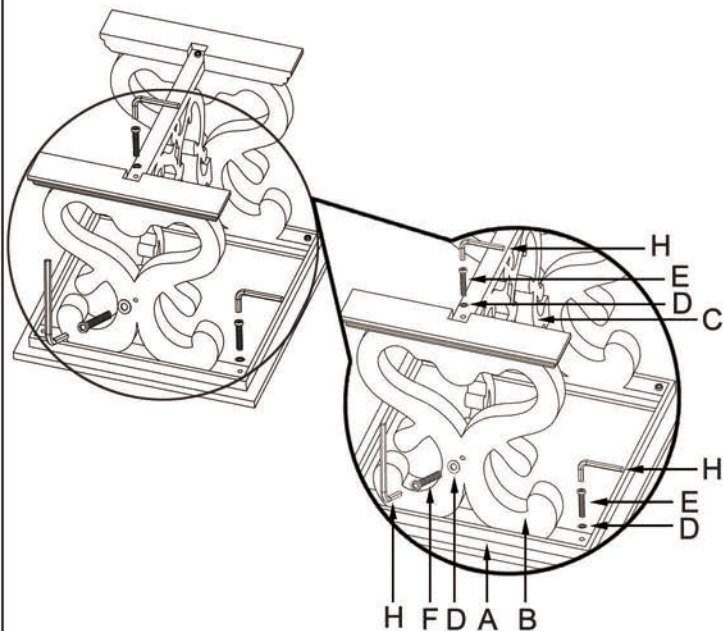

STEP FOUR:

