

Assembly | Asambla | Assemblage

PO# **PO102302**

Customer service | Servicio al cliente | Service clientèle: 800.633.5096

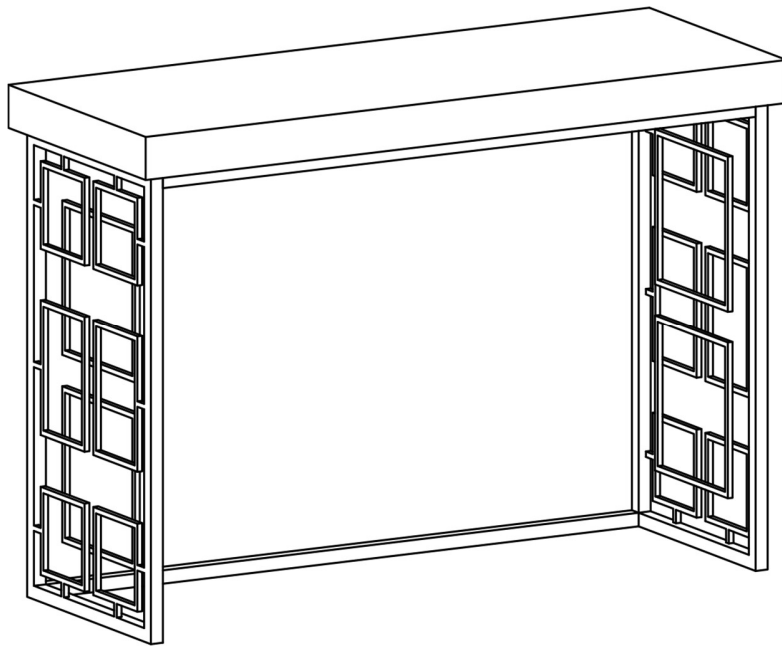

Product number | Número de producto | Numéro de produit

CM1104203

Thank you for your purchase! | ¡Gracias por tu compra! | Merci pour votre achat!

Assembly | Asambla | Assemblage

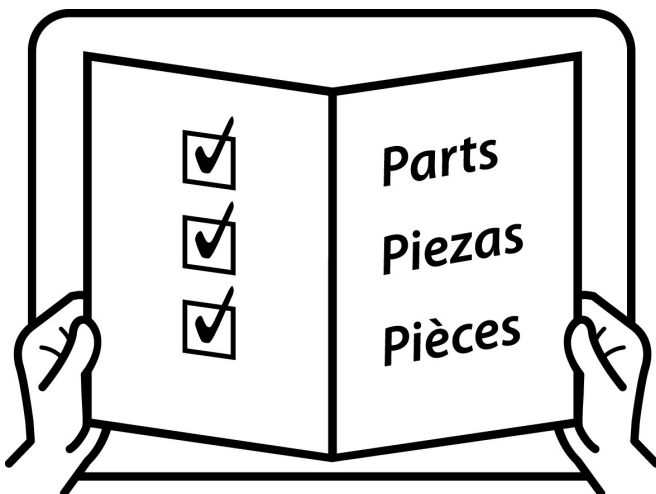
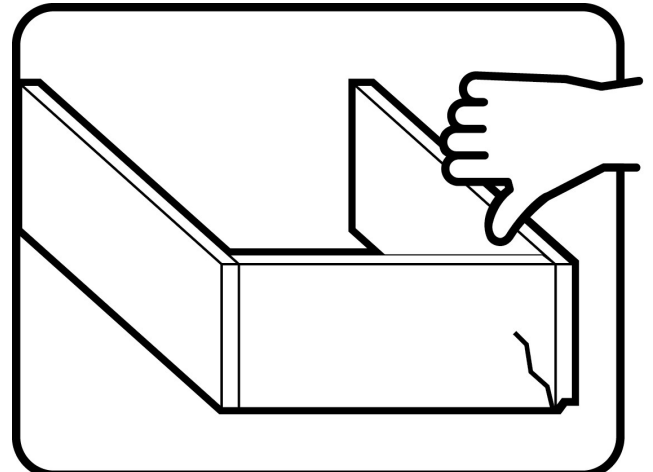
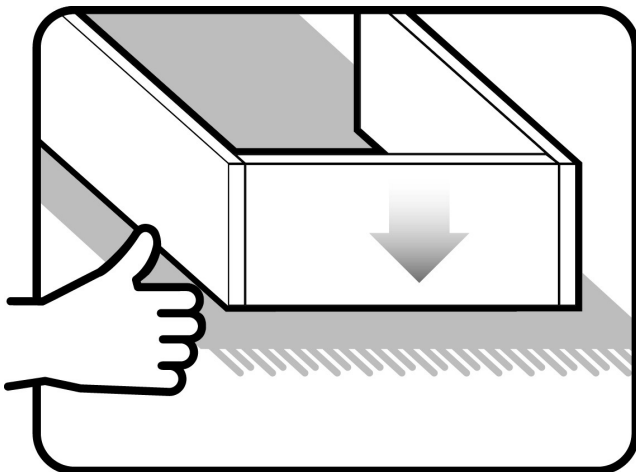
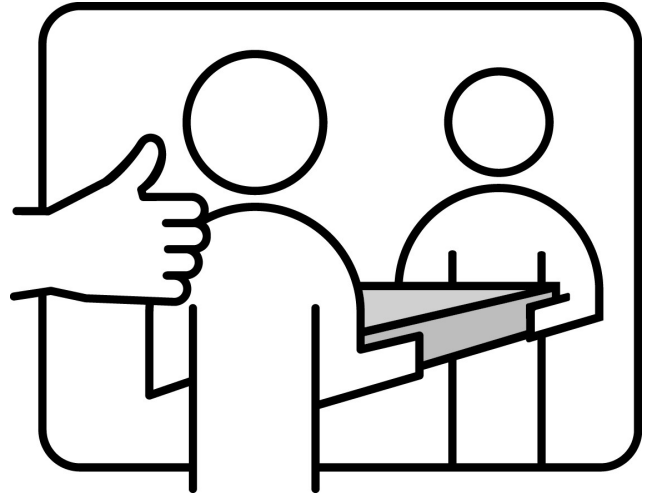
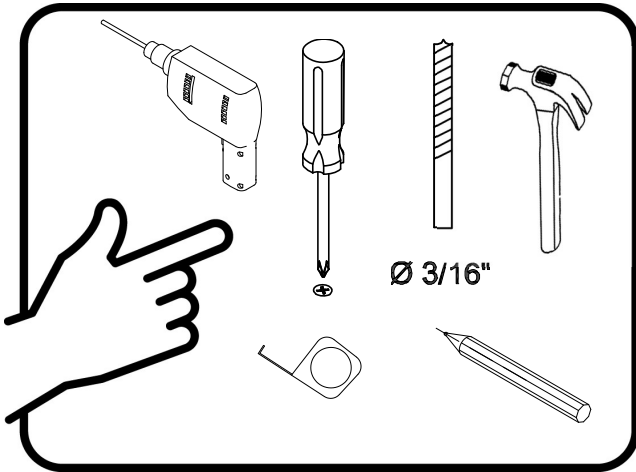

Assembly | Asamblea | Assemblage

Techniques | Técnicas | Techniques

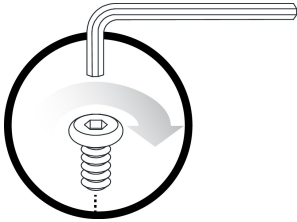

Care | Cuidado | Entretien

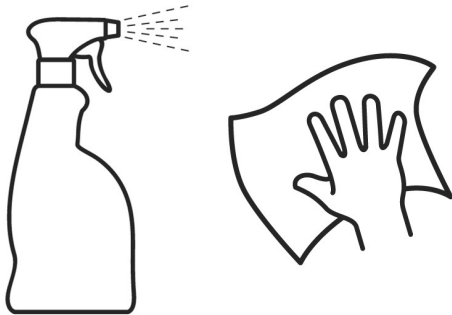



Safety | Seguridad | Sécurité



Note! | ¡Nota! | Remarque!



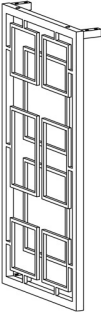
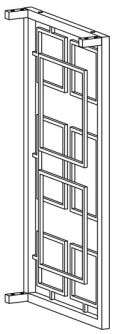

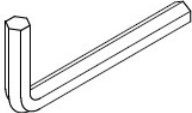
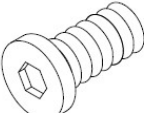
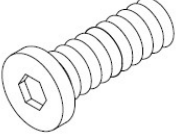
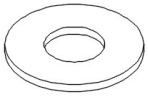
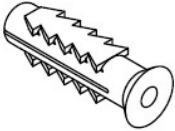
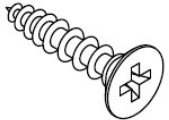
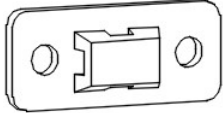
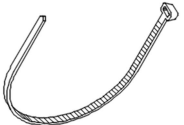
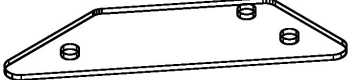

Assembly | Asamblea | Assemblage

<p>A x1</p>  <p>Top panel Panel superior Panneau supérieur</p>	<p>B x1</p>  <p>Left leg Pierna izquierda La jambe gauche</p>	<p>C x1</p>  <p>Right leg Pierna derecha Jambe droite</p>
<p>D x1</p>  <p>Base crossbar Barra transversal de la base Barre transversale de base</p>		
<p>1 x1</p>  <p>Allen wrench Llave allen Clé Allen ø1/4"</p>	<p>2 x8</p>  <p>Bolt Tornillo Boulon ø1/4"x5/8"L</p>	<p>3 x8</p>  <p>Bolt Tornillo Boulon ø1/4"x1-5/8"L</p>
<p>4 x16</p>  <p>Flat washer Arandela plana Rondelle plate ø1/4"</p>	<p>5 x4</p>  <p>Anchor Ancla Ancre</p>	<p>6 x4</p>  <p>Screw Tornillo Vis ø8mm*1-3/8"L</p>
<p>7 x2</p>  <p>Bracket Soporte Support</p>	<p>8 x2</p>  <p>Tie Lazo L'attache</p>	<p>9 x4</p>  <p>Connection iron plate</p>

Assembly | Asambla | Assemblage

1

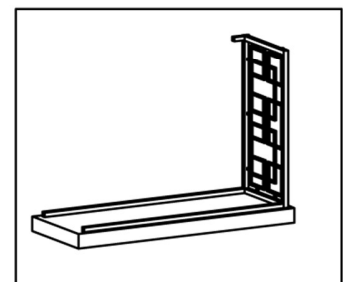
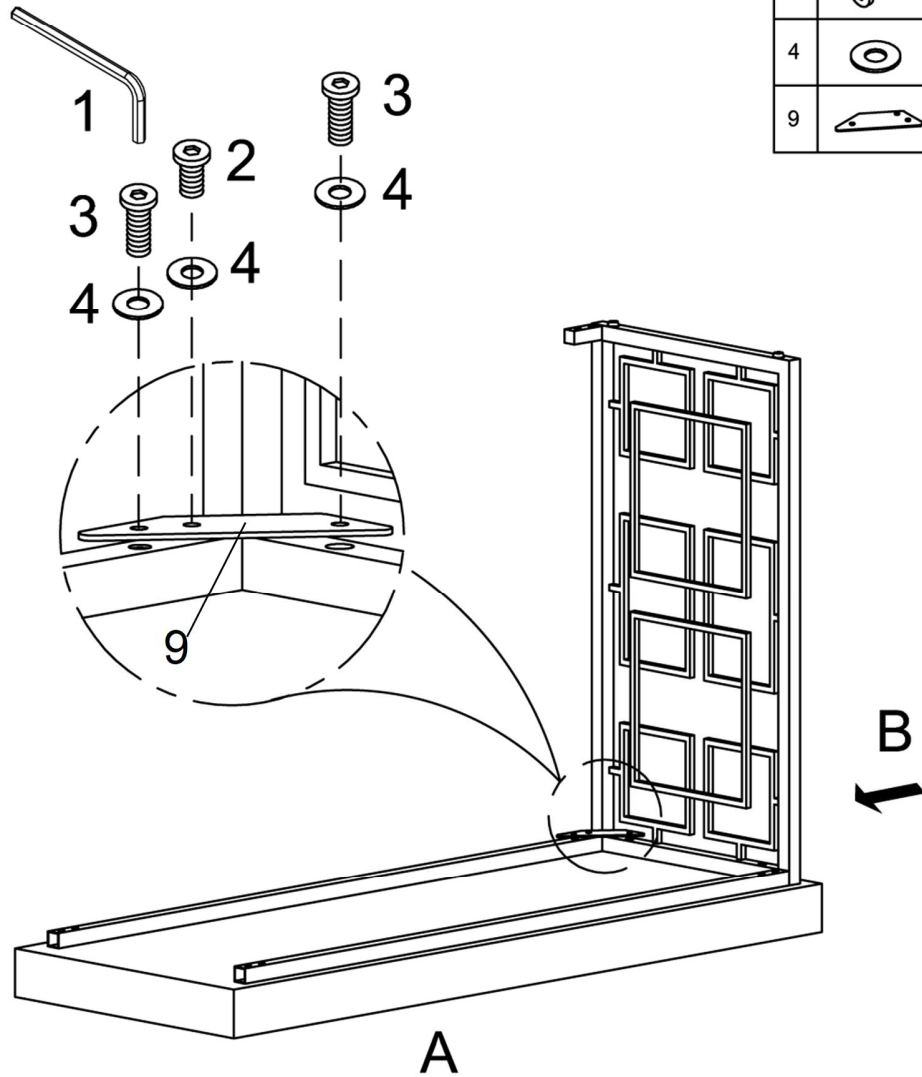

1		x1
2		x2
3		x4
4		x6
9		x2

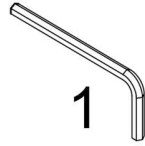

Assembly | Asambla | Assemblage

2





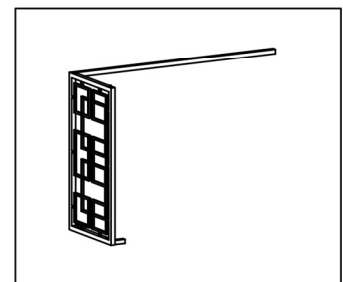
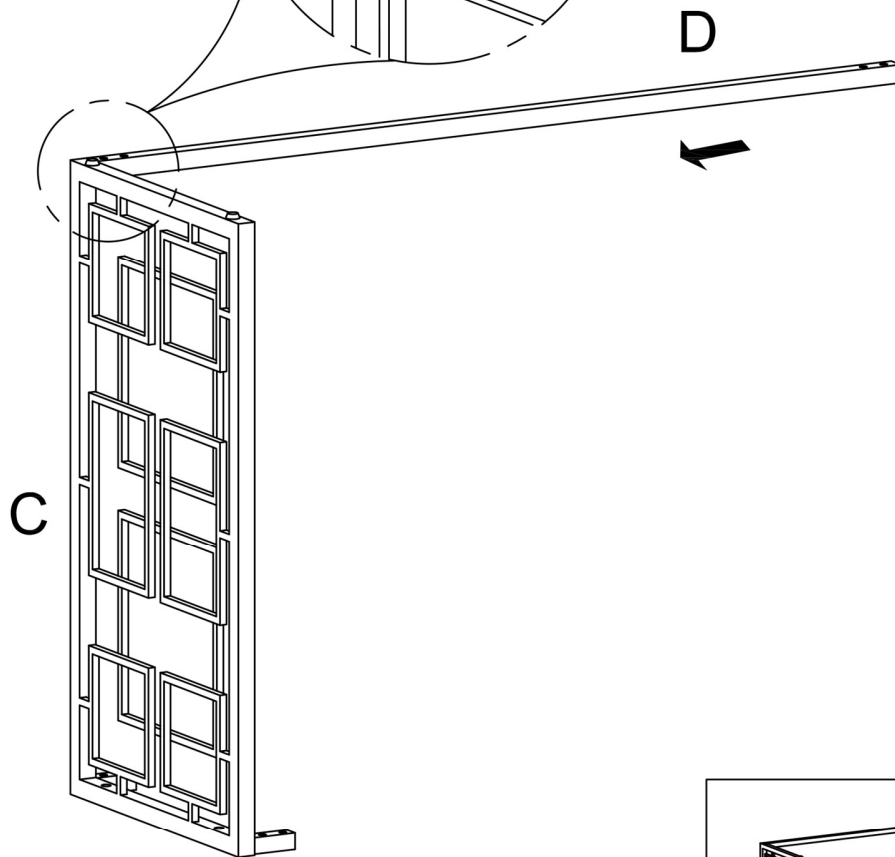
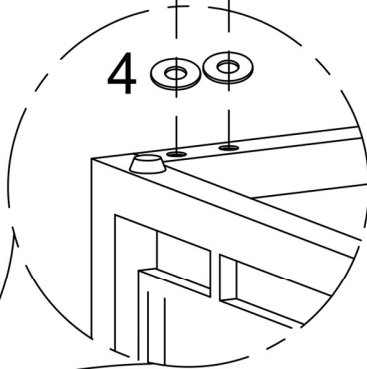

2		x2
4		x2

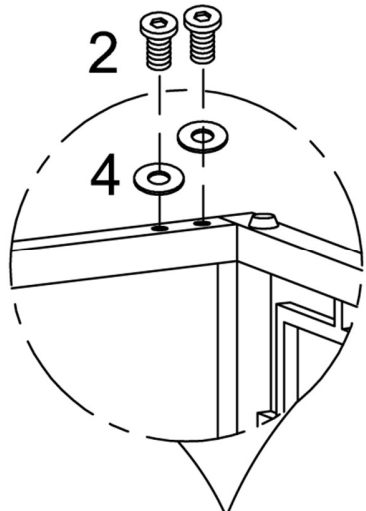
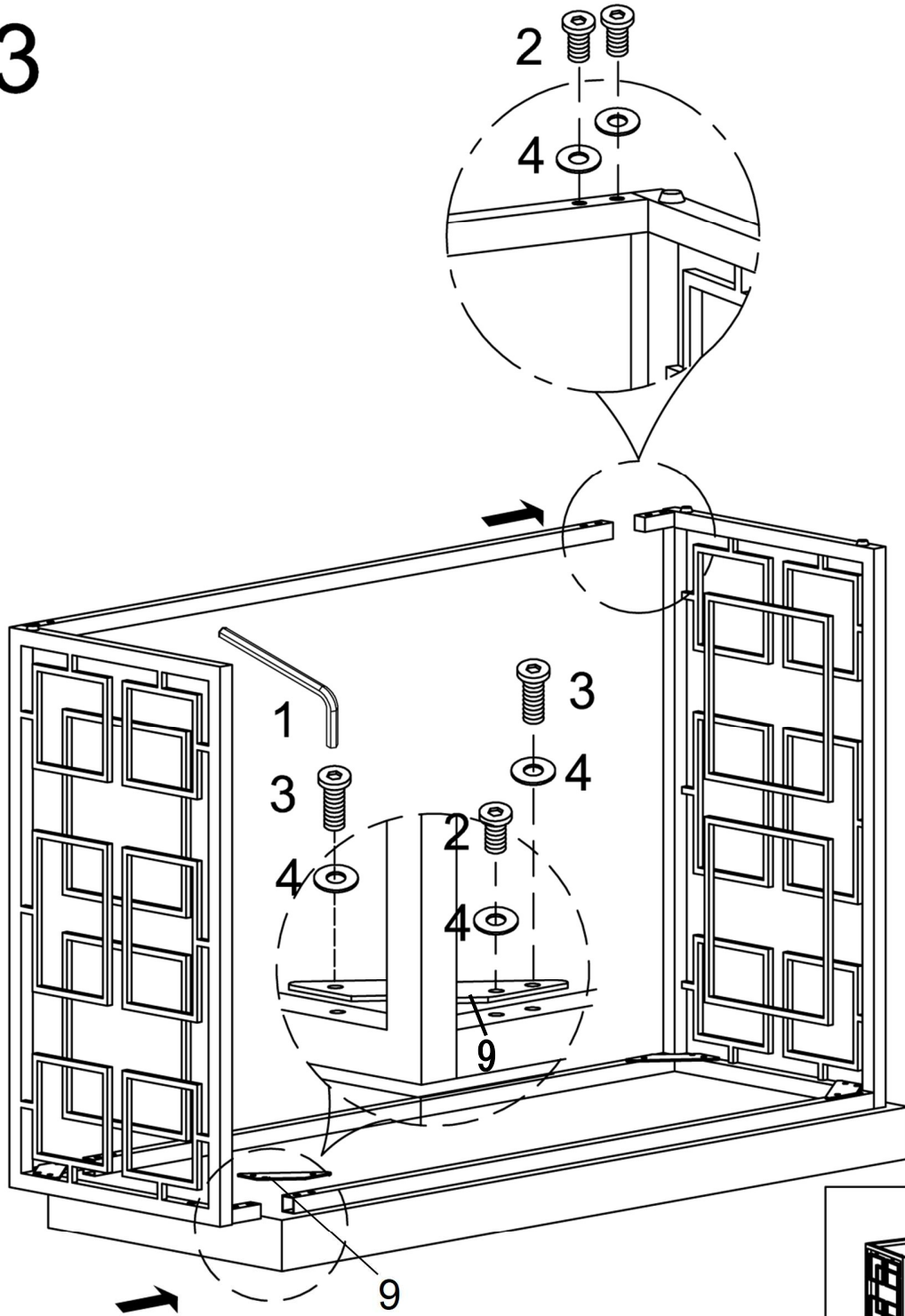

Assembly | Asamblea | Assemblage

3



2		x4
3		x4
4		x8
9		x2

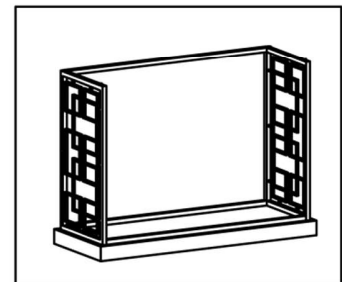



Assembly | Asambla | Assemblage

4

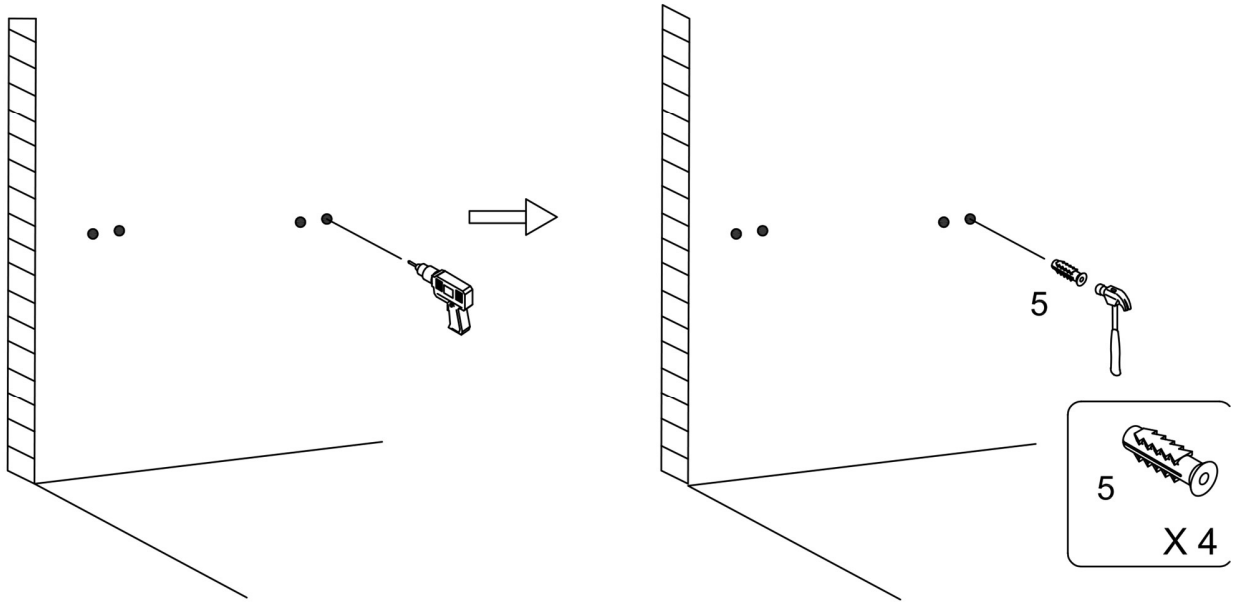
5		x4
---	---	----



5

6		x4
7		x2

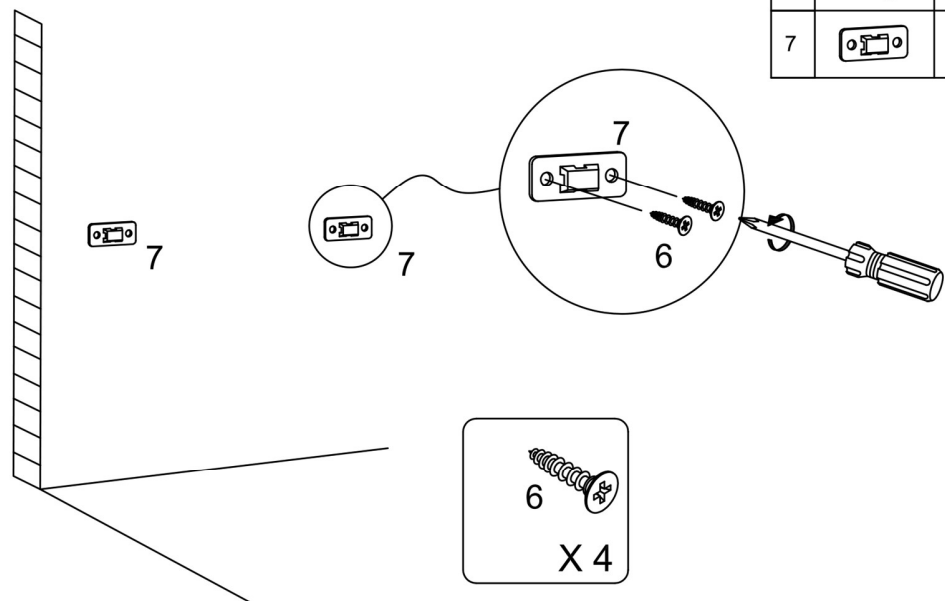

Assembly | Asambllea | Assemblage

6

8	U	2
---	---	---

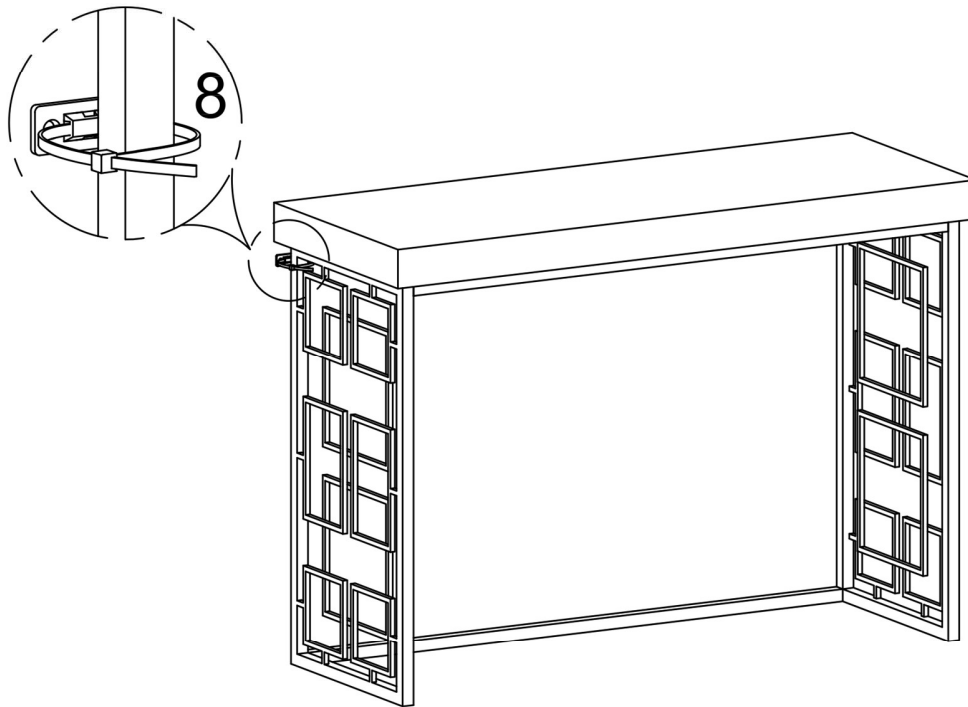

Assembly | Asamblea | Assemblage

Replacement Parts or Damages

You should examine your merchandise promptly upon receipt. For product concerns, please contact SEI Furniture customer service at 800-633-5096 Mon-Fri 8:30 am - 5 pm CST. Please have your purchase information ready when you call.

Requests for missing or damaged parts must be requested within one year of purchase. Damages or missing parts reported outside of one year will not be honored. SEI Furniture is under no obligation to provide parts or replacement merchandise. Replacement part requests will not be honored for fully assembled or modified items.

For merchandise purchased from an online retailer, please contact their customer service for parts or returns.

Merchandise purchased as “like new,” “open box,” or “as is,” or from private parties are exempt from replacement parts.

One Year Limited Warranty

Product warranty applies to the original purchaser with items in original factory-sealed cartons. Proof of purchase date, price, and seller must be shown to validate the warranty. This warranty covers defects in manufacturing. It does not apply to any defects caused by negligence, misuse, accidental damage, or improper assembly. Glass and mirrors are excluded from this warranty. Warranty does not extend to cosmetic damage, accidents, misuse, abuse, or neglect. Liability for incidental or consequential damages is excluded to the maximum extent permitted by law.

After verification of claim, SEI Furniture will repair or replace any defective product or missing part. If the defective item must be returned in whole or in part, we will send written authorization and a pre-addressed shipping label for the return of any defective product or part.

No returns will be accepted without prior approval.

Assembly | Asamblea | Assemblage

Piezas de Repuesto o Daños

Debe examinar su mercancía inmediatamente después de recibirla. Si tiene inquietudes sobre el producto, comuníquese con el servicio al cliente de SEI Furniture al 800-633-5096 de lunes a viernes de 8:30 am a 5 pm CST. Tenga a mano la información de su compra cuando llame.

Las solicitudes de piezas faltantes o dañadas deben solicitarse en el plazo de un año a partir de la compra. Los daños o piezas faltantes informados fuera de un año no serán aceptados. SEI Furniture no tiene la obligación de proporcionar piezas o mercadería de reemplazo. No se aceptarán solicitudes de piezas de repuesto para artículos completamente ensamblados o modificados.

Para mercadería comprada en un minorista en línea, comuníquese con su servicio de atención al cliente para obtener piezas o devoluciones.

La mercancía comprada como "como nueva", "caja abierta" o "como está" o de particulares están exentas de piezas de repuesto.

Garantía Limitada de un Año

La garantía del producto se aplica al comprador original con los artículos en cajas de cartón originales selladas de fábrica. Se debe mostrar el comprobante de la fecha de compra, el precio y el vendedor para validar la garantía. Esta garantía cubre defectos de fabricación. No se aplica a ningún defecto causado por negligencia, mal uso, daño accidental o montaje inadecuado. Los vidrios y espejos están excluidos de esta garantía. La garantía no se extiende a daños cosméticos, accidentes, mal uso, abuso o negligencia. La responsabilidad por daños incidentales o consecuentes está excluida en la medida máxima permitida por la ley.

Después de la verificación de la reclamación, SEI Furniture reparará o reemplazará cualquier producto defectuoso o pieza faltante. Si el artículo defectuoso debe devolverse en su totalidad o en parte, le enviaremos una autorización por escrito y una etiqueta de envío con la dirección predeterminada para la devolución de cualquier producto o pieza defectuosa.

No se aceptarán devoluciones sin aprobación previa.

Assembly | Asamblea | Assemblage

Pièces de Rechange ou Dommages

Vous devez examiner votre marchandise dès sa réception. Pour toute question concernant les produits, veuillez contacter le service client de SEI Furniture au 800-633-5096 du lundi au vendredi de 8h30 à 17h00 CST. Veuillez avoir vos informations d'achat prêtes lorsque vous appelez.

Les demandes de pièces manquantes ou endommagées doivent être effectuées dans l'année suivant l'achat. Les dommages ou pièces manquantes signalés en dehors d'un an ne seront pas honorés. SEI Furniture n'a aucune obligation de fournir des pièces ou des marchandises de remplacement. Les demandes de pièces de rechange ne seront pas honorées pour les articles entièrement assemblés ou modifiés.

Pour les marchandises achetées auprès d'un détaillant en ligne, veuillez contacter leur service client pour les pièces ou les retours.

Les marchandises achetées comme “comme neuves”, “boîte ouverte” ou “en l'état” ou auprès de parties privées sont exemptées de pièces de rechange.

Garantie Limitée d'un An

La garantie du produit s'applique à l'acheteur d'origine avec des articles dans des cartons d'origine scellés en usine. La date d'achat, le prix et le vendeur doivent être présentés pour valider la garantie. Cette garantie couvre les défauts de fabrication. Elle ne s'applique pas aux défauts causés par une négligence, une mauvaise utilisation, des dommages accidentels ou un assemblage incorrect. Le verre et les miroirs sont exclus de cette garantie. La garantie ne s'étend pas aux dommages cosmétiques, aux accidents, à la mauvaise utilisation, à l'abus ou à la négligence. La responsabilité pour les dommages accessoires ou indirects est exclue dans la mesure maximale permise par la loi.

Après vérification de la réclamation, SEI Furniture réparera ou remplacera tout produit défectueux ou pièce manquante. Si l'article défectueux doit être retourné en tout ou en partie, nous vous enverrons une autorisation écrite et une étiquette d'expédition pré-adressée pour le retour de tout produit ou pièce défectueux.

Aucun retour ne sera accepté sans accord préalable.