

# TV Stand

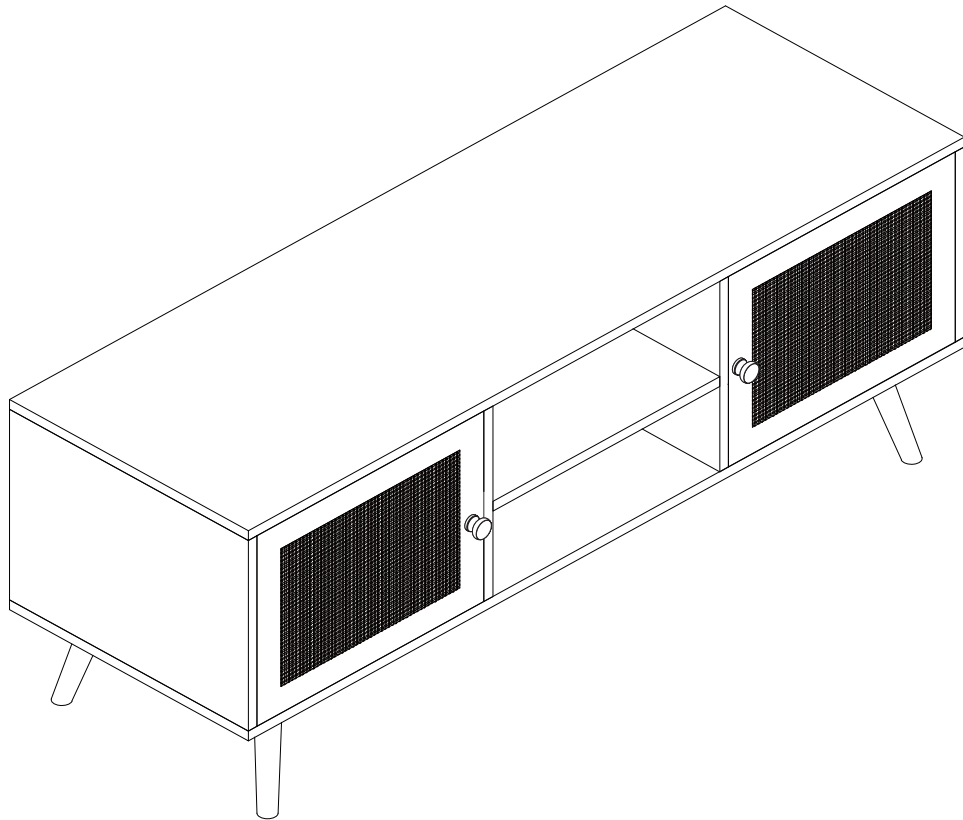

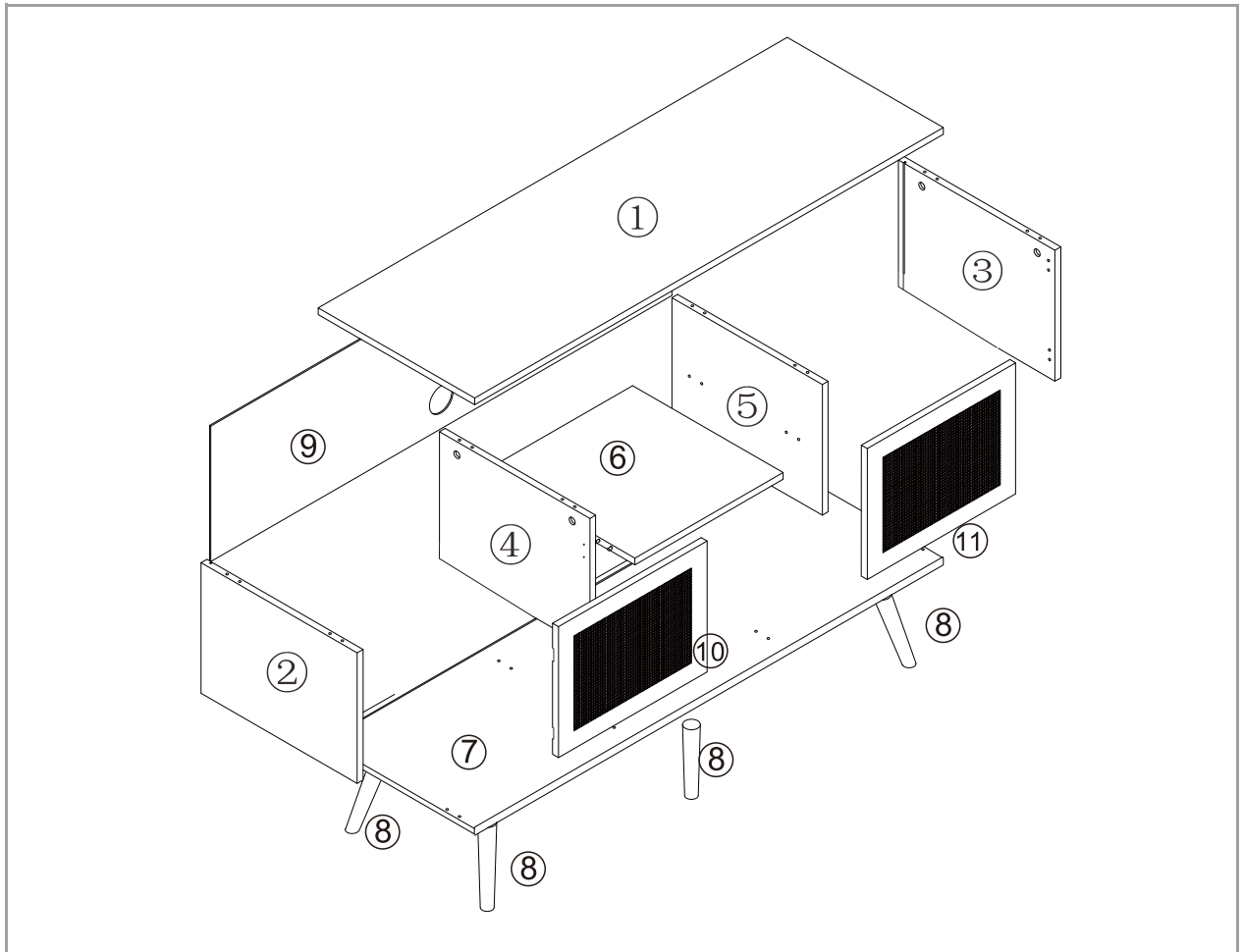







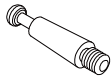

## ASSEMBLY INSTRUCTION

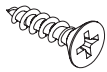
# PARTS LITS



# HARDWARE LITS

<p>A</p>  <p>x12</p> <p>φ 15</p>	<p>B</p>  <p>x12</p> <p>M6x35mm</p>	<p>C</p>  <p>x20</p> <p>M6x30mm</p>	<p>D</p>  <p>x 2</p>	<p>E</p>  <p>x 2</p>
<p>F</p>  <p>x18</p> <p>M3x12mm</p>	<p>G</p>  <p>x 2</p> <p>M4x25mm</p>	<p>H</p>  <p>x 4</p>	<p>I</p>  <p>x 8</p> <p>M4x35mm</p>	<p>J</p>  <p>x 4</p> <p>M3x14mm</p>
<p>K</p>  <p>x 4</p>	<p>L</p>  <p>x16</p> <p>M4x12mm</p>	<p>M</p>  <p>x 2</p>		

# ASSEMBLY STEPS

**1**

Insert quickfit screws (B) to part 4 and 5.

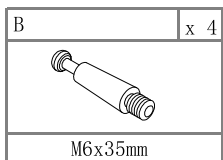
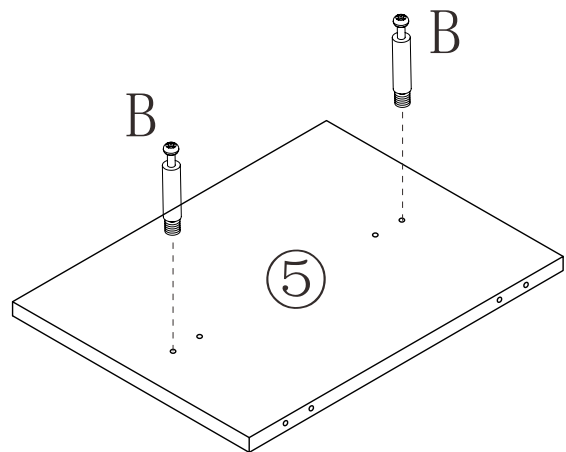
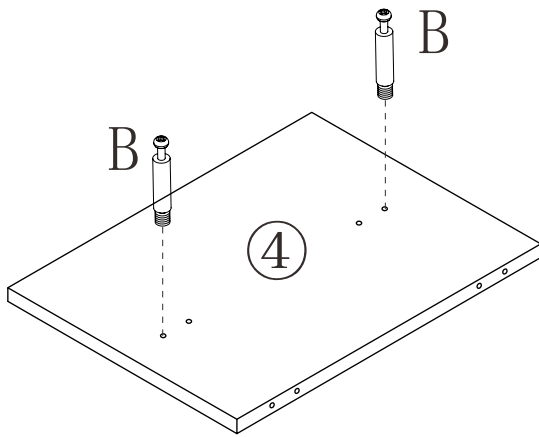

**2**

Insert cam locks (A) and wooden dowels (C) to part 6.  
Fit part 4 to part 6.  
Turn cam locks clockwise to tighten.

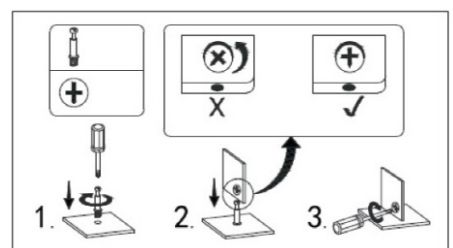
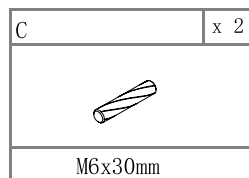
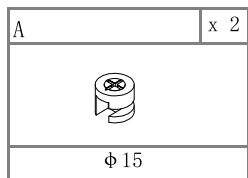
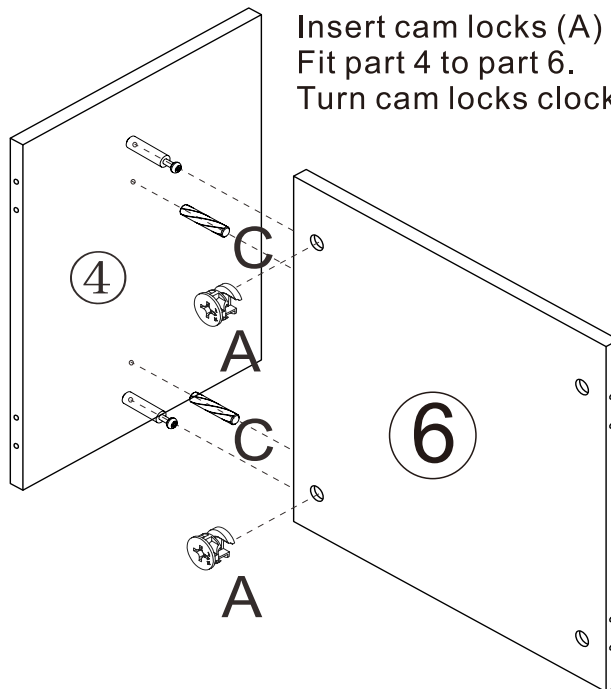

**3**

Insert cam locks (A) and wooden dowels (C) to part 6.  
 Fit part 5 to part 6.  
 Turn cam locks clockwise to tighten.

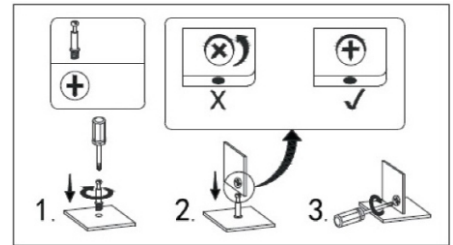
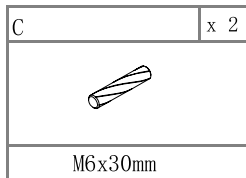
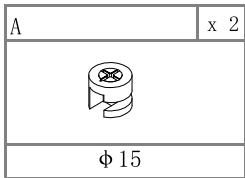
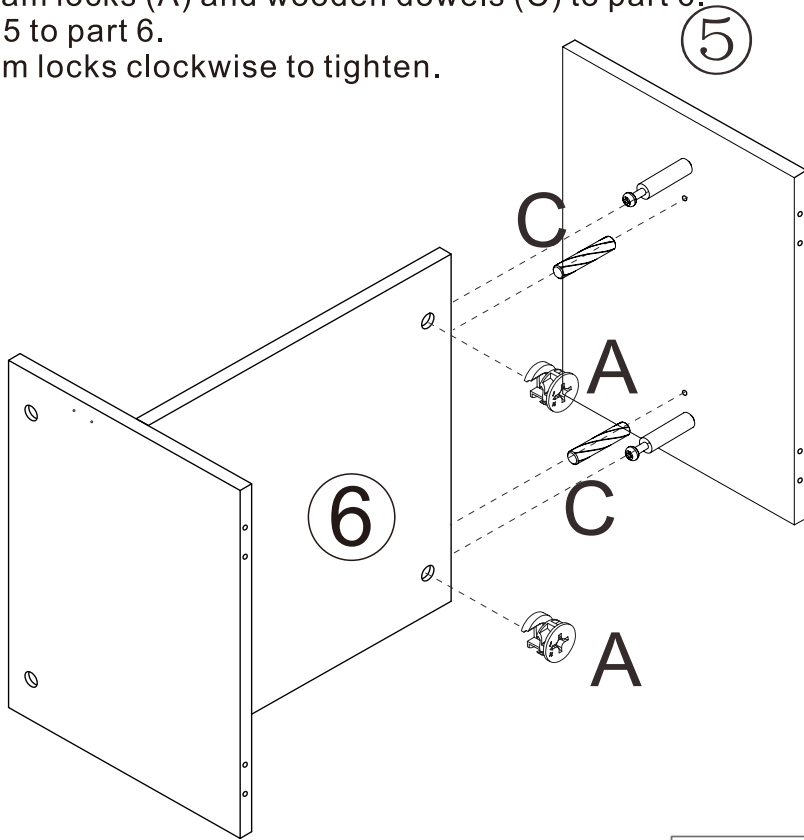
**4**

Insert quickfit screws (B) to part 1.

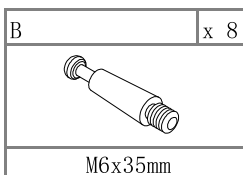
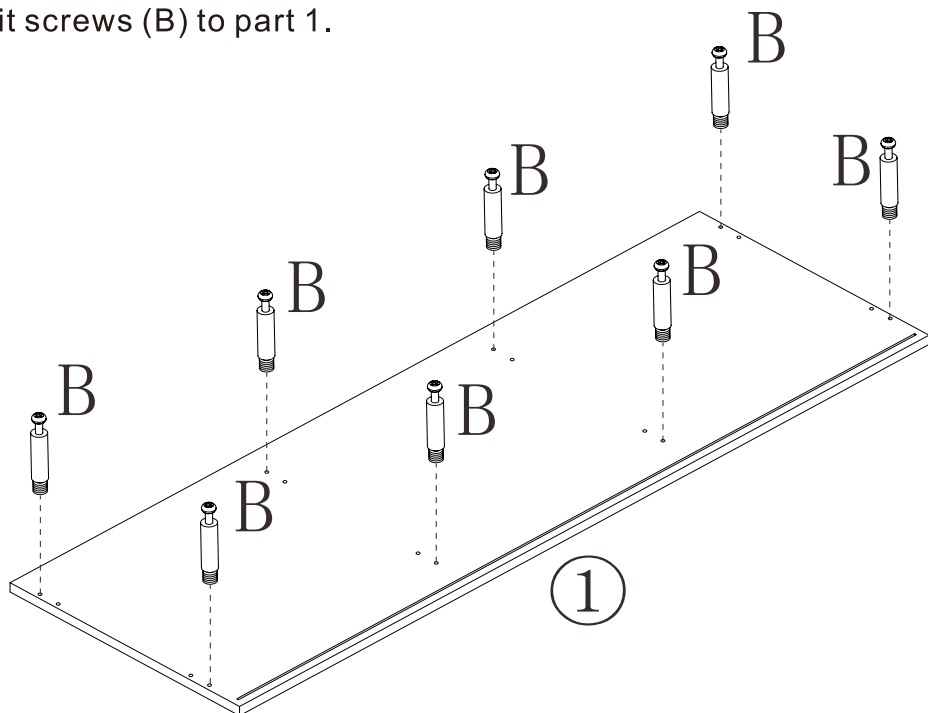

**5**

Insert cam locks (A) and wooden dowels (C) to part 4 and 5.  
Fit assembled part 4 and 5 to part 1, as shown.  
Turn cam locks clockwise to tighten.

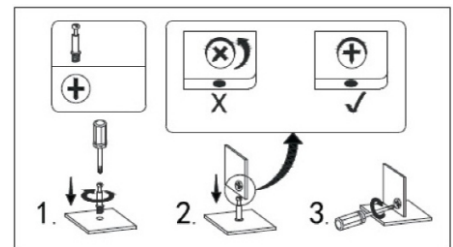
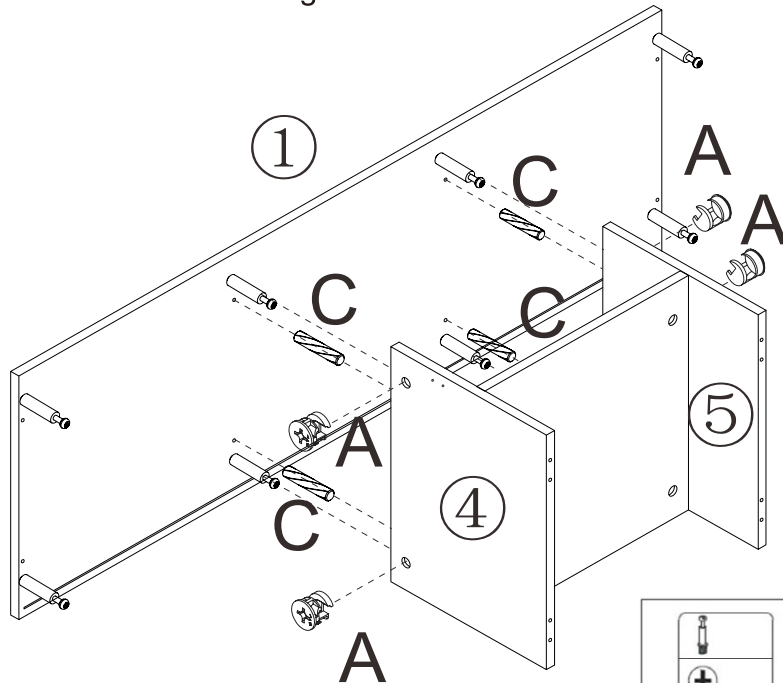



A	x 4
	
φ 15	

C	x 4
	
M6x30mm	

**6**

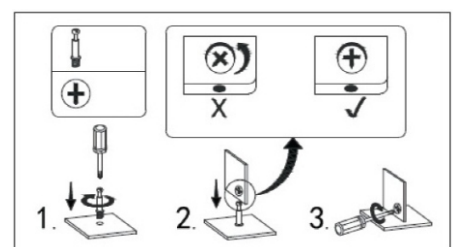
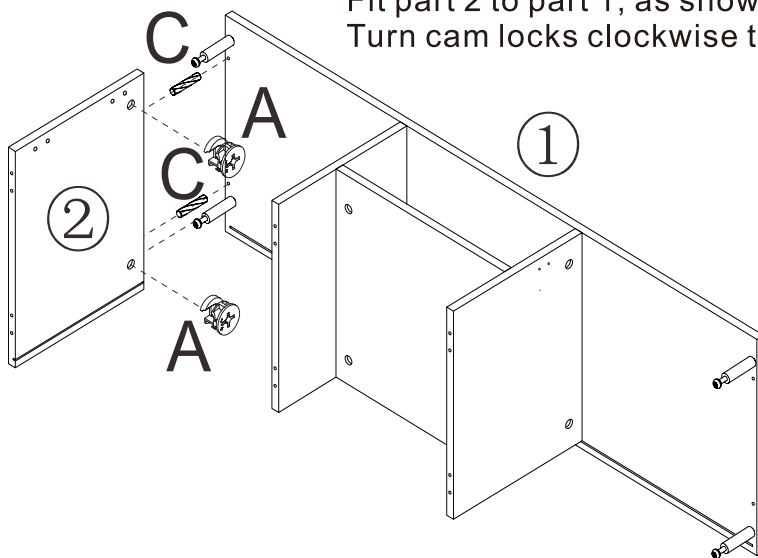
Insert cam locks (A) and wooden dowels (C) to part 2.  
Fit part 2 to part 1, as shown.  
Turn cam locks clockwise to tighten.



A	x 2
	
φ 15	

C	x 2
	
M6x30mm	

**7**

Insert cam locks (A) and wooden dowels (C) to part 3.  
 Fit part 3 to part 1, as shown.  
 Turn cam locks clockwise to tighten.

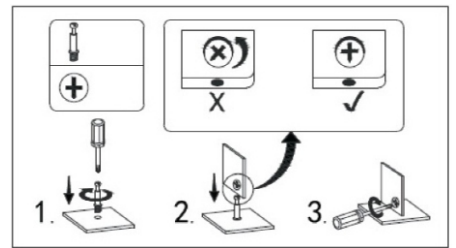
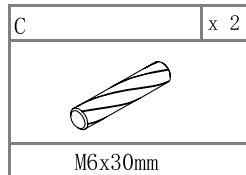
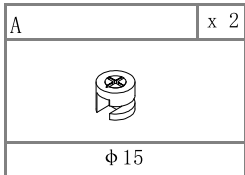
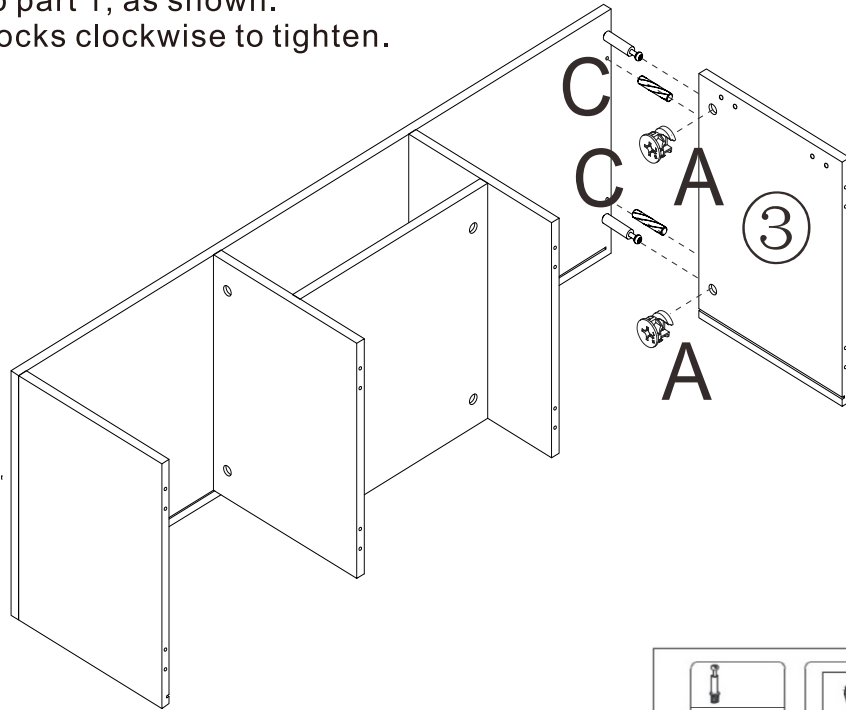
**8**

Fix hardware (D) to part 4 and 5 using screws (J), as shown.  
 Slide part 10 into grooves between part 2 and 3.

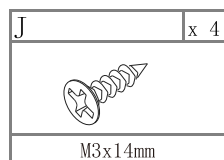
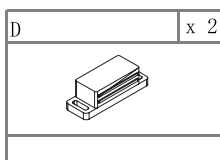
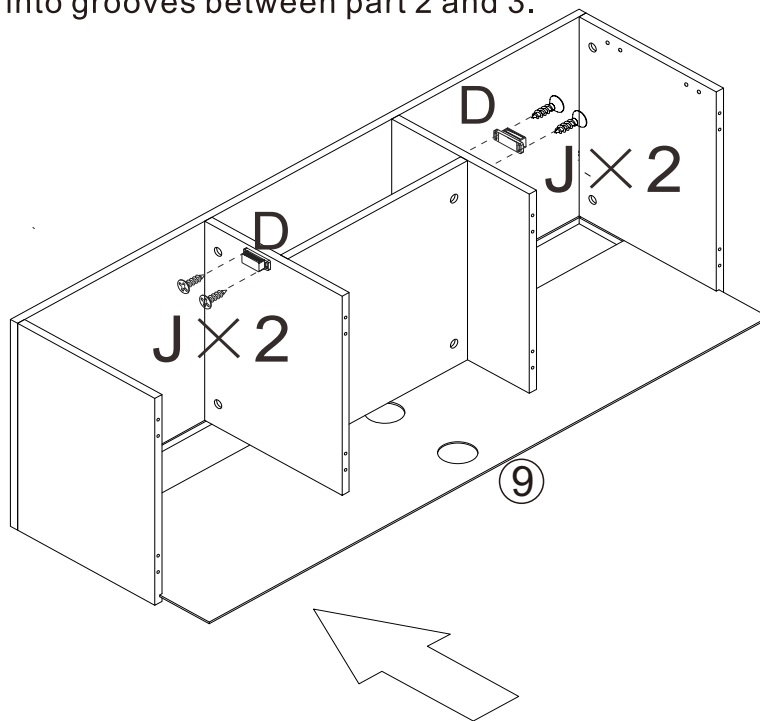

9

Fix leg supports (K) to part 7 using screws (L), as shown.

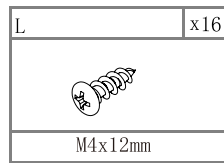
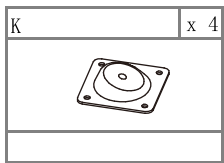
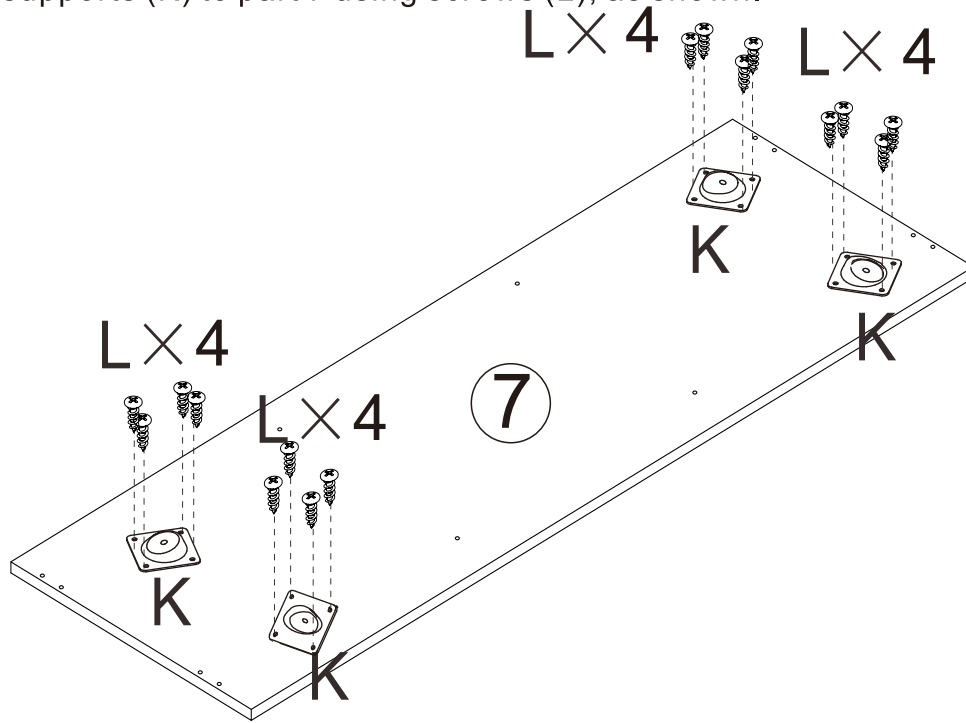

10

Insert wooden dowels (C) to assembled parts, as shown.

Fit part 7 to assembled parts.

Secure part 7 to assembled parts using screws (I), as shown.

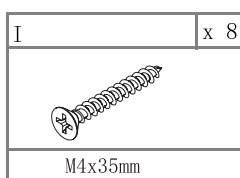
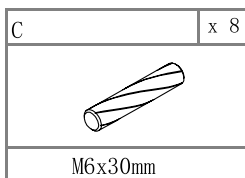
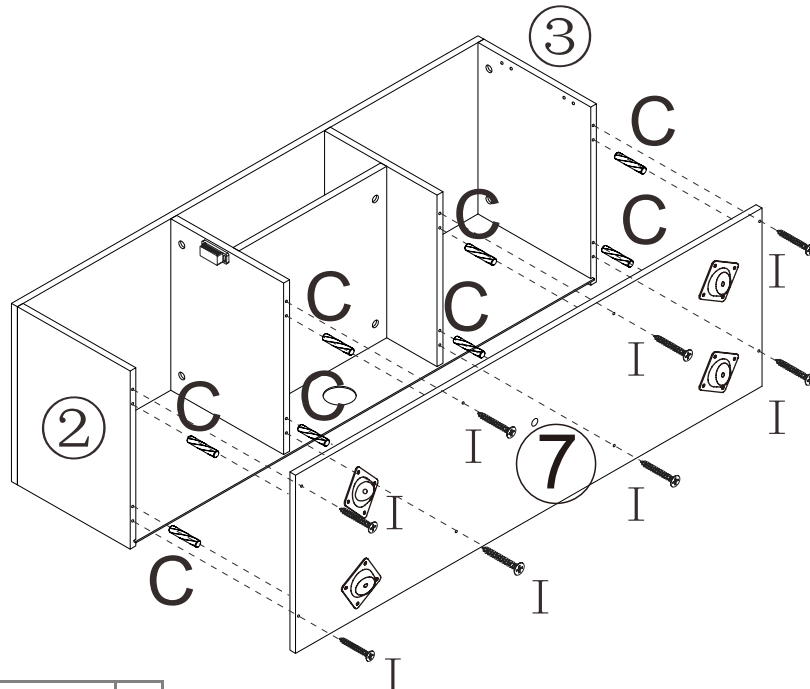

**11**

Turn legs 8 clockwise into leg supports attached on part 7, as shown.

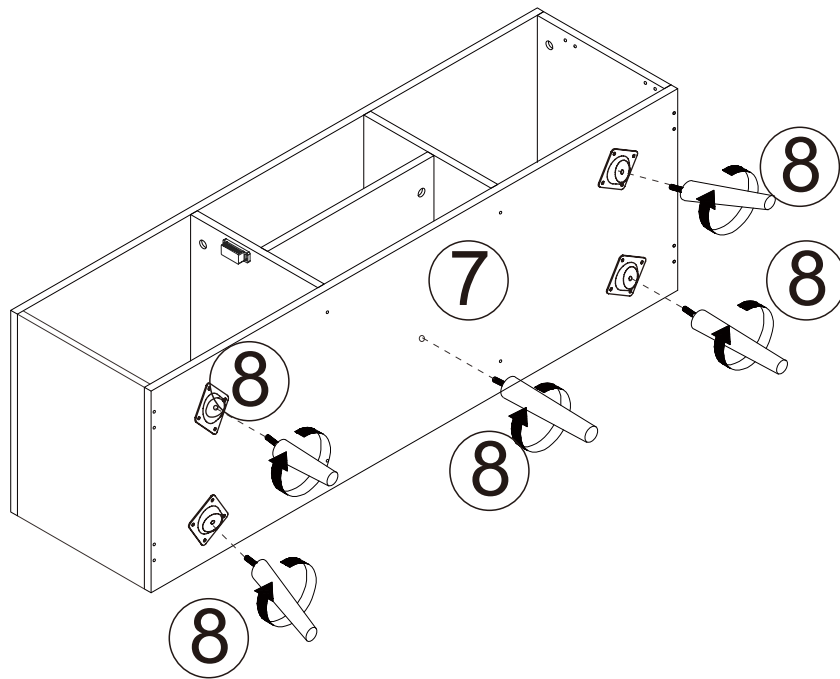
**12**

Fix Hinges (H) to door 10 and part 2 using screws (F), as shown.

Fix handle (M) to door 10 using screw (G), as shown.

Fix hardware (E) to door 10 using screw (G), as shown.

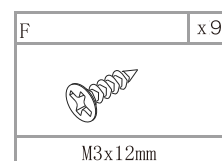
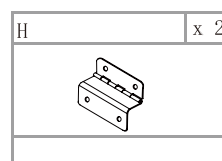
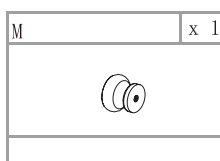
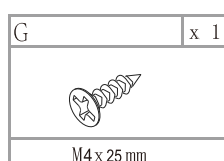
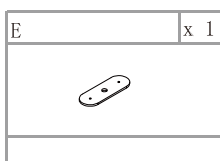
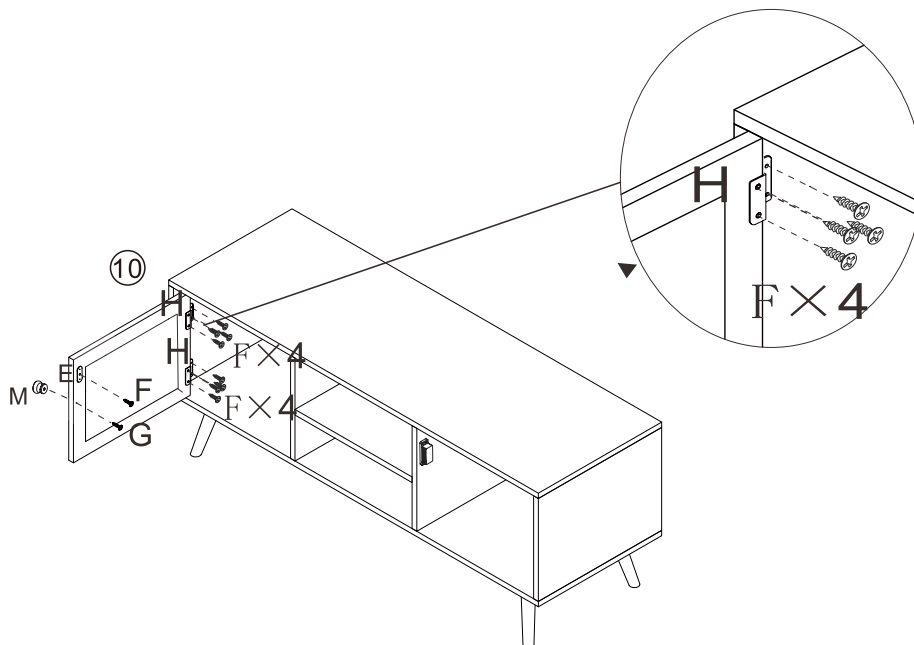



**13**

Fix Hinges (H) to door 11 and part 3 using screws (F), as shown.  
Fix handle (M) to door 11 using screw (G), as shown.  
Fix hardware (E) to door 11 using screw (G), as shown.

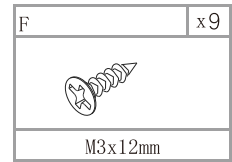
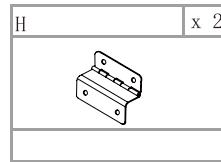
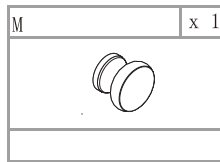
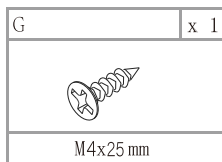
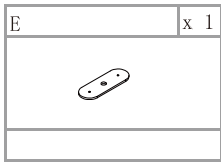
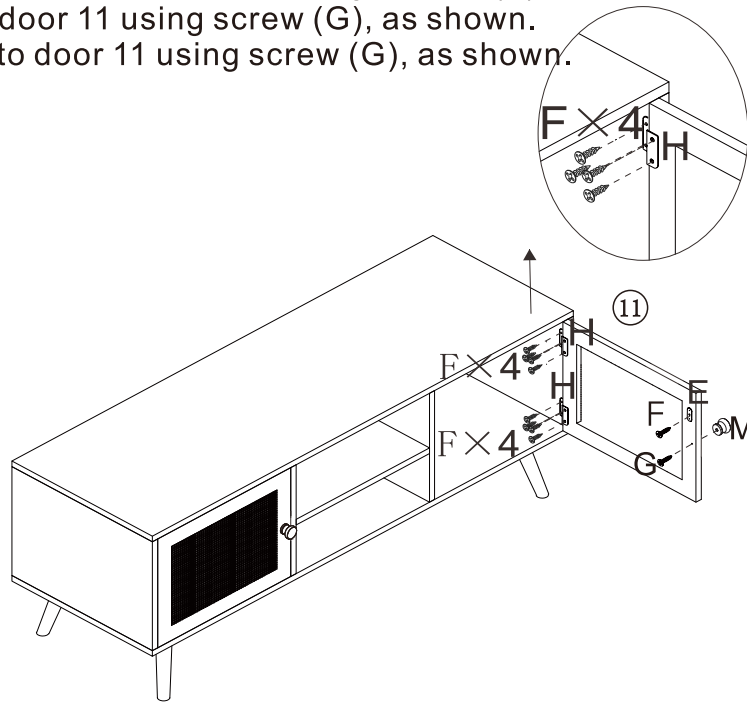
**14**