



MANHATTAN
COMFORT

ASSEMBLY INSTRUCTIONS

INSTRUCCIONES DE MONTAJE

NOTICE DE MONTAGE

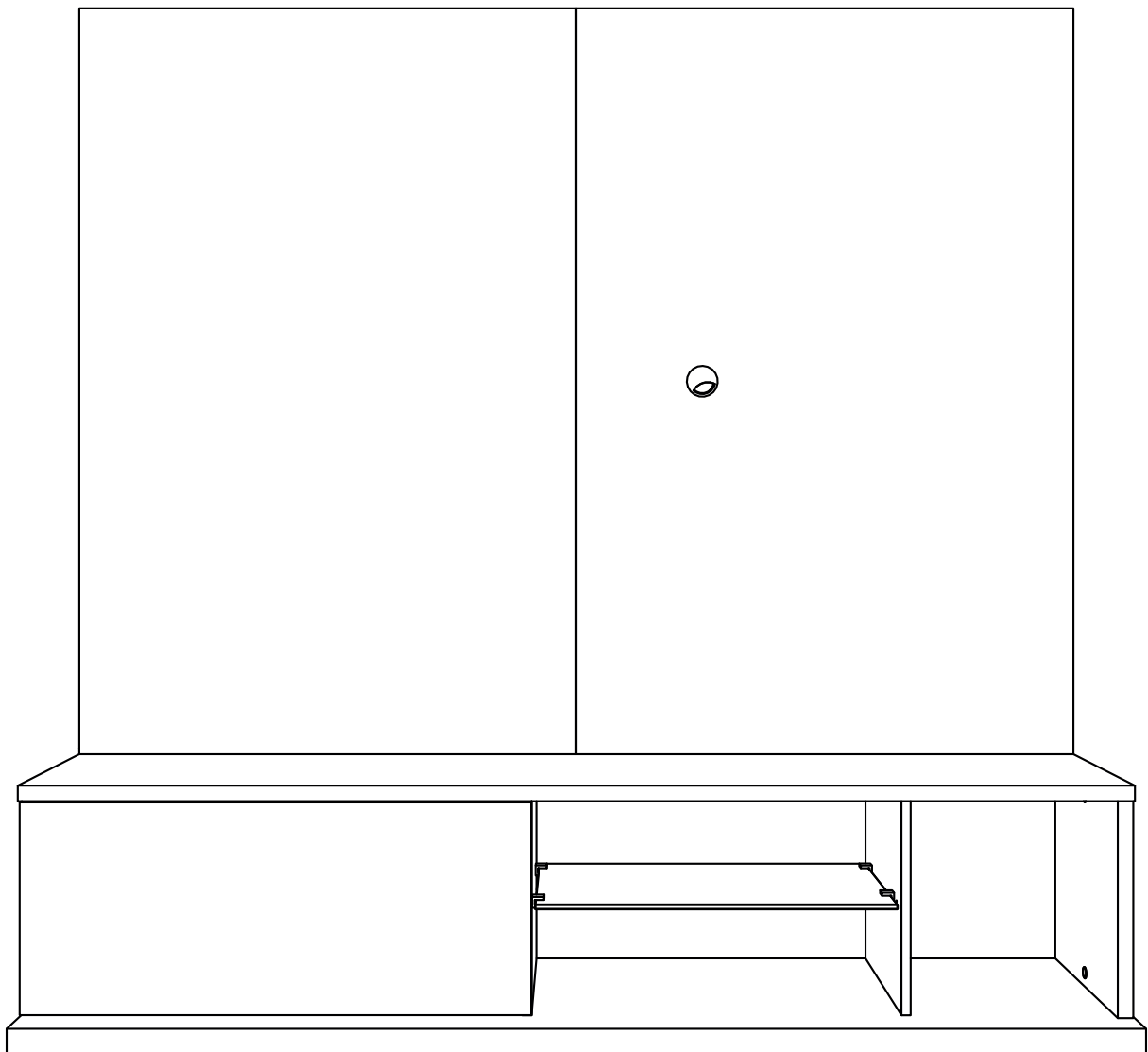

COD BR: 400700

REV. 01 - 02/04/20

STICKER-18x
ADHESIVO-18x
AUTOCOLLANT-18x

COD. 1668-16x



B

COD. 9425-2x

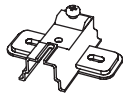

C

COD. 8903-2x

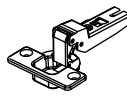

D

COD. 2014-3x

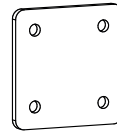

E

COD. 4157-5x

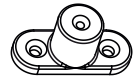

F

A

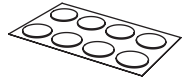

WIRE CHANNEL - 1x
PASA EL CABLE - 1x
PASSE-CÂBLES - 1x

COD. 0357



G

SUPORT TV - 1x

APOYO DE TV - 1x

SUPPORT MURAL POUR TV-1



H

COD. 0348-1x



J

COD. 2088-10x



K

COD. 0607-8x

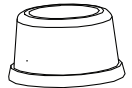

L

COD. 9070-5x

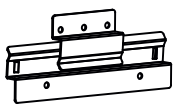

M

COD. 4439-4x

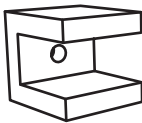

N

COD. 10063-8x



O

COD. 9895-8x

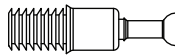

P

COD. 2762-1x

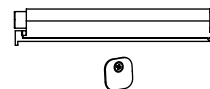

Q

COD. 10084-1x

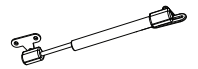

R

COD. 1533-8x



S

COD. 7519-8x



T

COD. 3557-3x

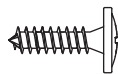

U

COD. 3706-12x

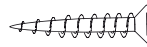

V

COD. 1861-8x



X

COD. 6244-12x



Z

VIDRO
 VIDRIO
 GLASS

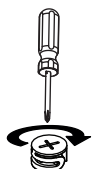
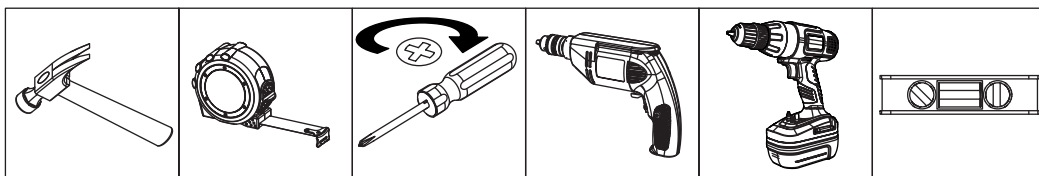

DESCRIPTION

DESCRIPCIÓN

DESCRIPTION

W:70.86 inches H:70.15 inches D: 17.32 inches

L:1800mm A:1782mm P:440mm



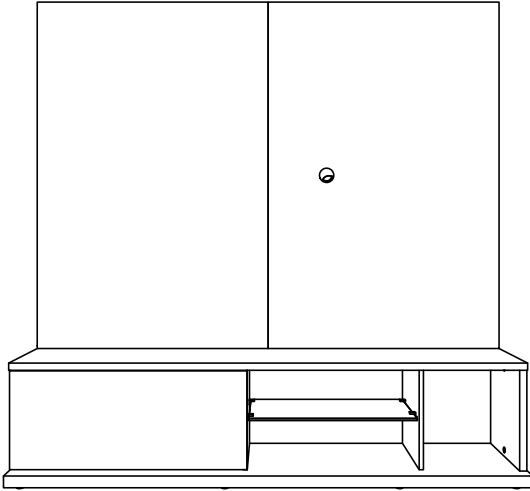



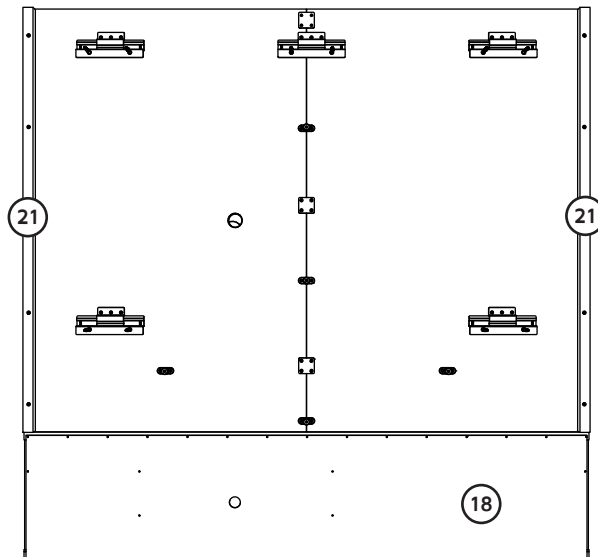
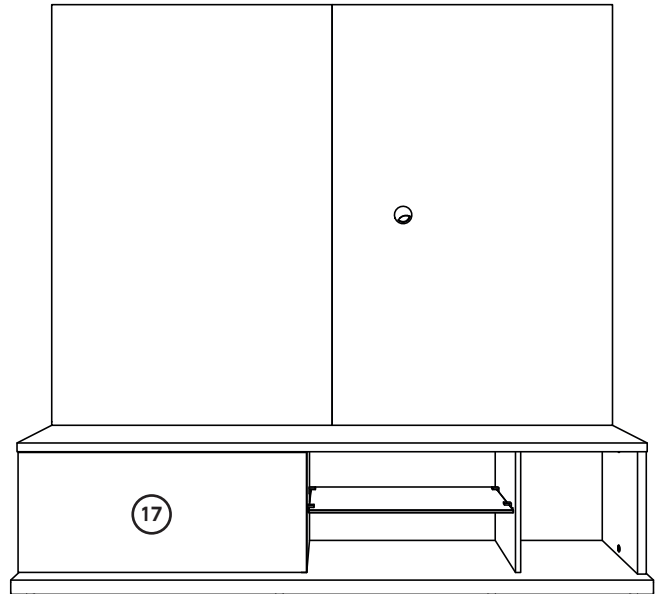
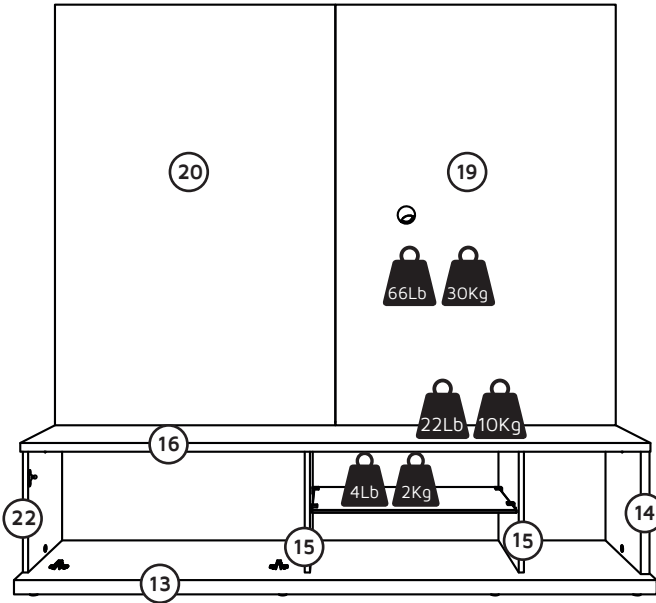

L:1800mm H:1782mm P:440mm



CÓD:400700					
PART PIEZA PIECE	QUANTITY CANTIDAD QUANTITÉ	DESCRIPTION	DESCRIPCIÓN	DESCRIPTION	BOX CAJA BOÎTE
13	01	BASE	BASE	BASE	01
14	01	SIDE	LATERAL	CÔTÉ	01
15	02	INTERNAL SIDE	LATERAL INT.	CÔTÉ INTÉRIEUR	01
16	01	TOP BOARD	CUBIERTA	PLATEAU	01
17	01	DOOR	PUERTA	PORTE	01
18	01	BACKPLATE	FONDO	FOND	01
19	01	PANEL RIGHT	PANEL DERECHO	PANNEAU DROIT	02
20	01	PANEL LEFT	PANEL IZQUIERDO	DROIT GAUCHE	02
21	02	SIDE BATTEN	SOPORTE LATERAL	LATTE LATÉRALE	02
22	01	SIDE	LATERAL	LATTES	01

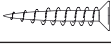
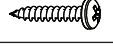

01

COD. 9425 C 	COD. 2014 E 	COD. 4157 F 	COD. 0348 J 	COD. 0607 L 	COD. 9070 M 	COD. 9895 P 	COD. 7519 T 	COD. 3557 U 
COD. 3706 V 	COD. 1861 X 							

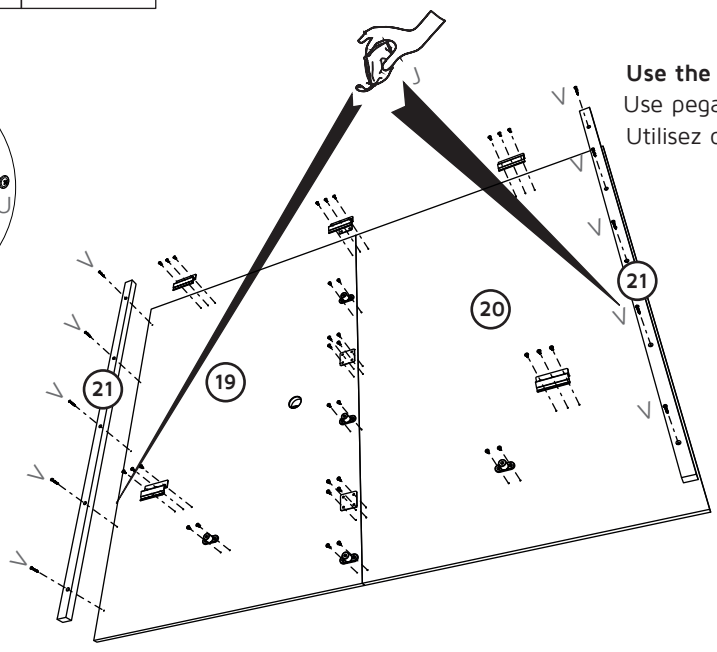
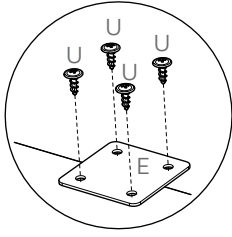
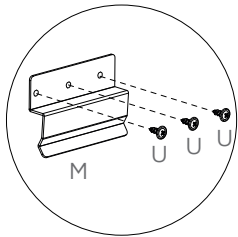

Use the PVA glue before screwing.
 Use pegamento PVA antes de atornillar.
 Utilisez de la colle PVA avant de visser.

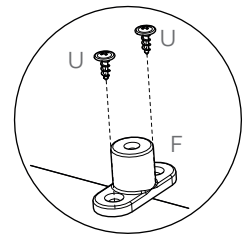

02

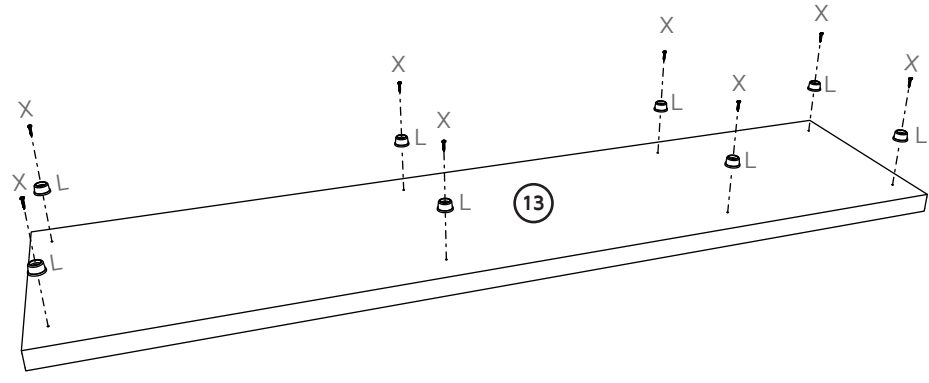

03

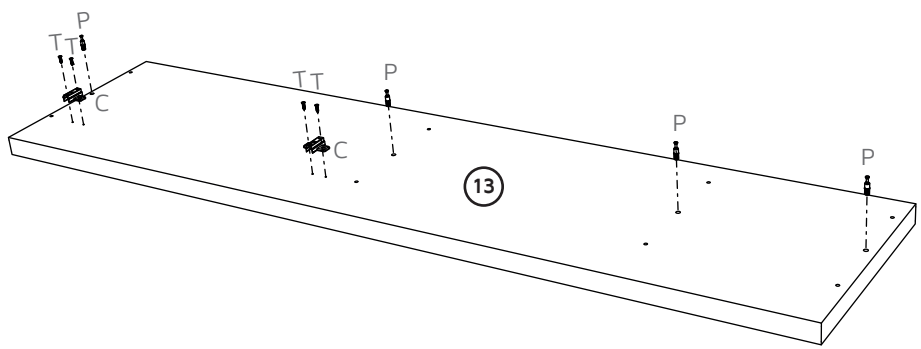

STICKER ADHESIVO AUTOCOLLANT A	COD. 1668 B	COD. 8903 D	COD. 0357 H	COD. 4439 N	COD. 10063 O	COD. 9895 P	COD. 10084 R	COD. 1533 S	COD. 7519 T
--	-----------------------	-----------------------	-----------------------	-----------------------	------------------------	-----------------------	------------------------	-----------------------	-----------------------

04

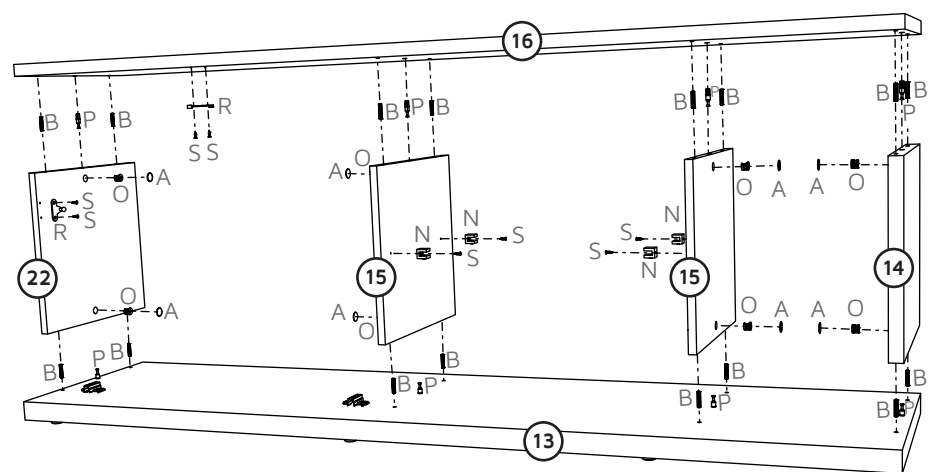

05

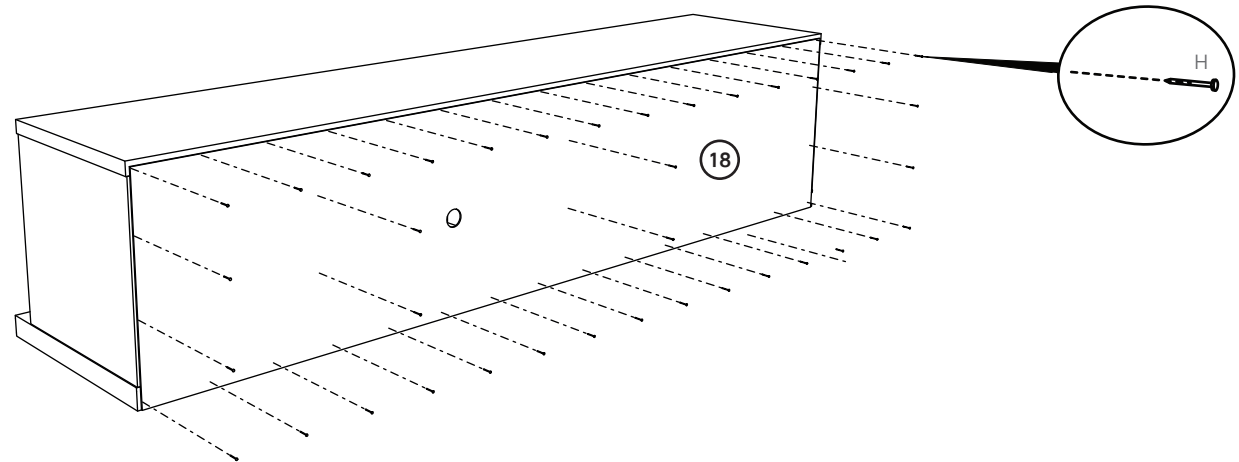

06

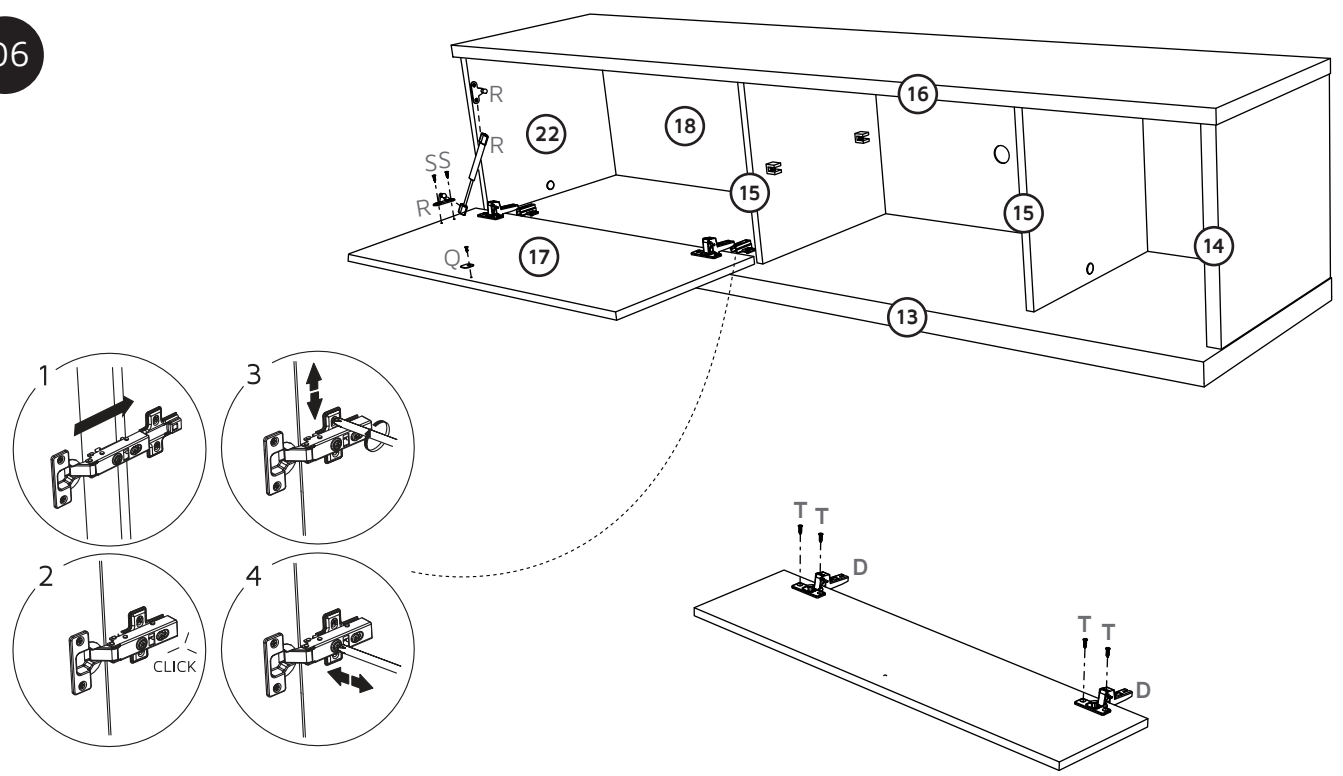

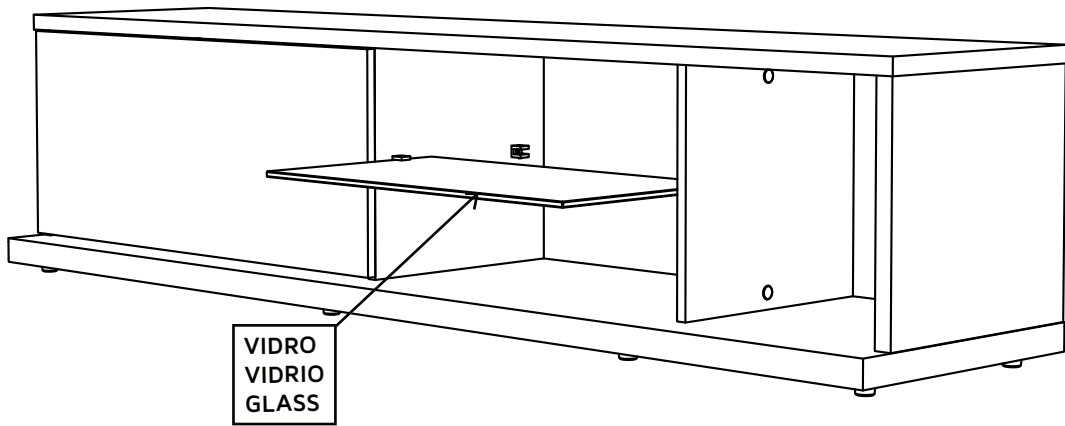

Medidas para realizar a furação da parede
(em milímetros).
Measurement to drill the wall
(in millimeters).
Medidas para realizar la perforación de la pared
(en milímetros).

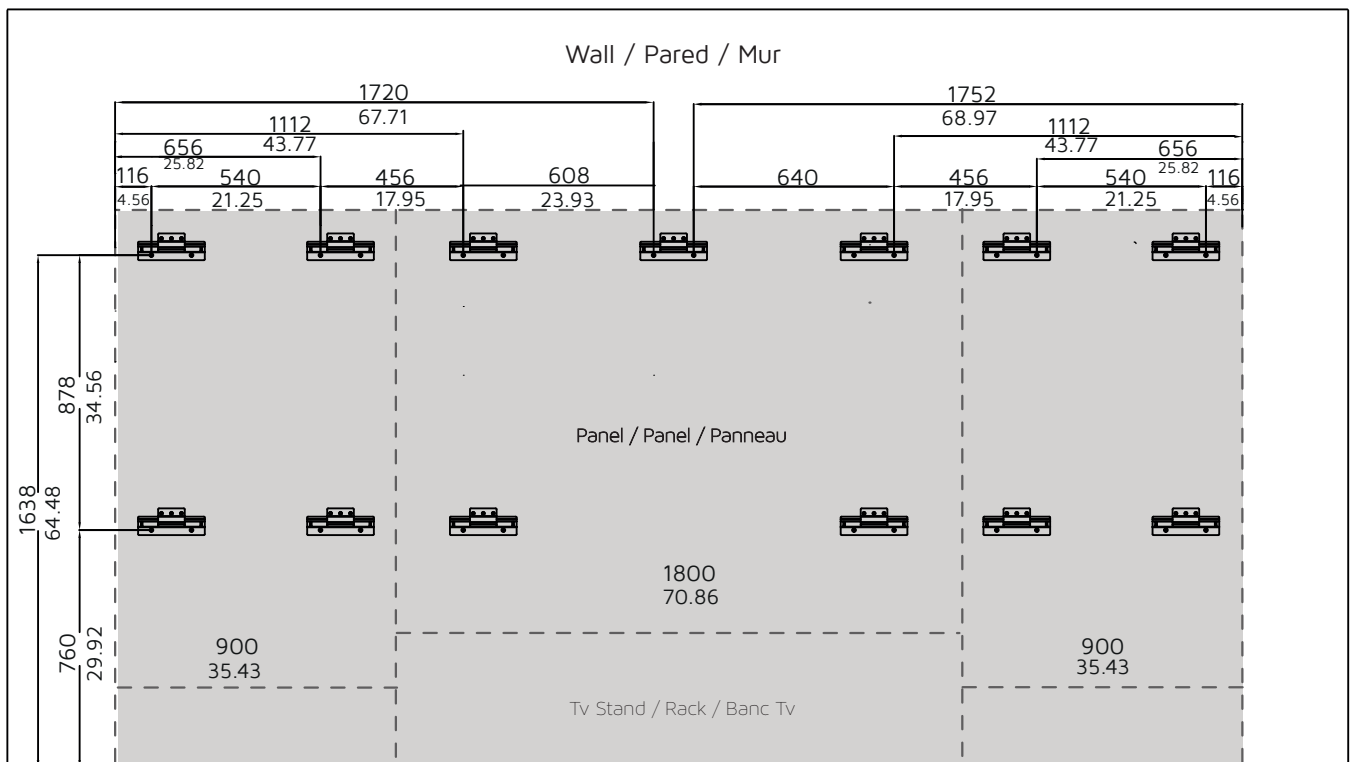
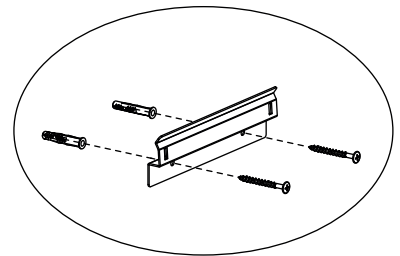
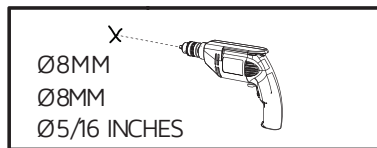
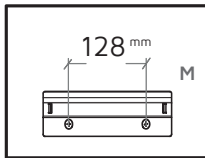

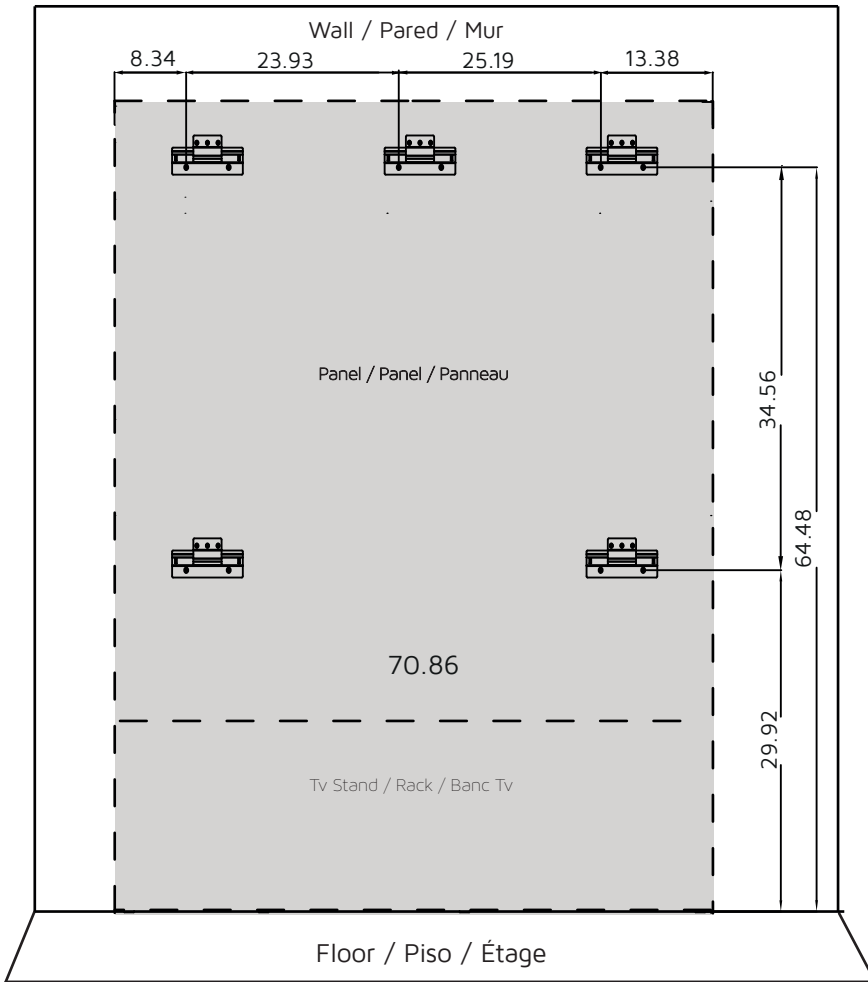
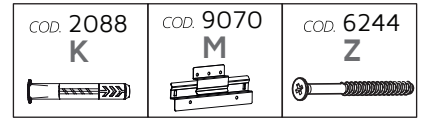

Measurement to drill the wall.
(em inches).

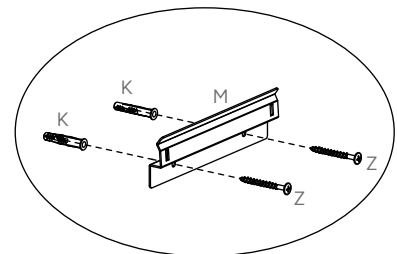
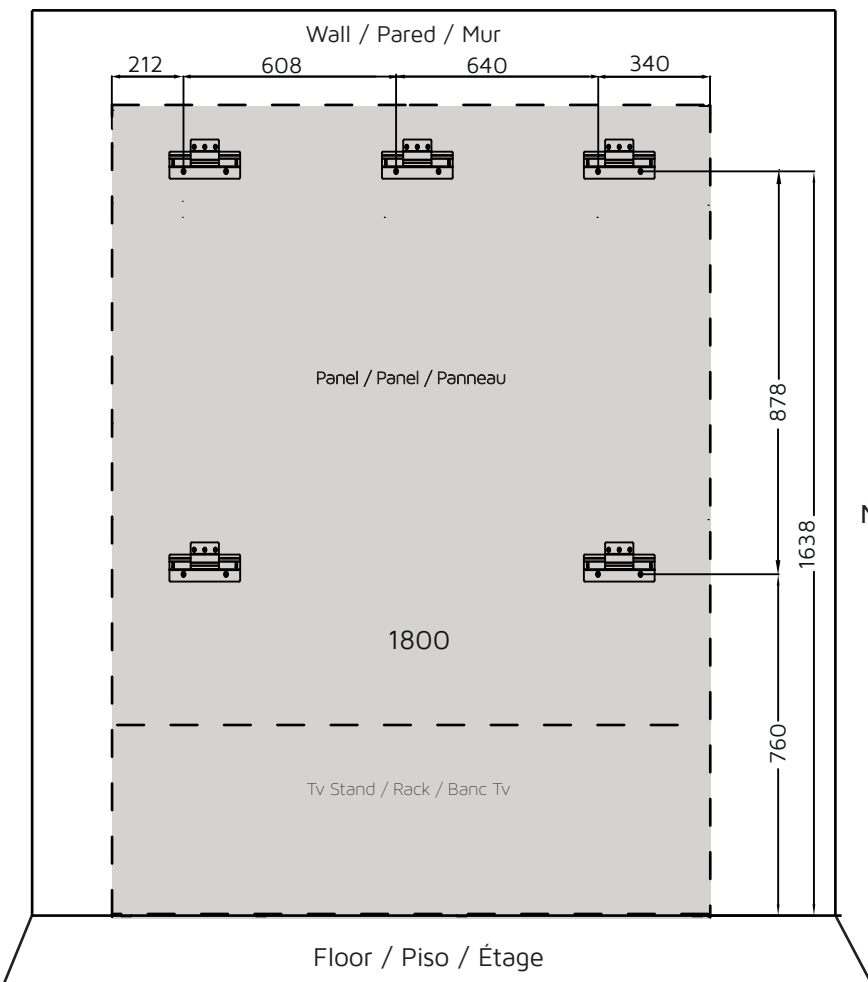
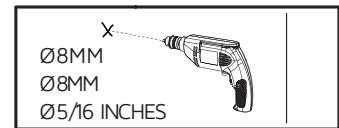
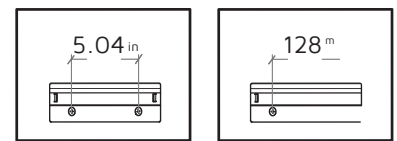

Medidas para realizar la perforación de la pared
(en milímetros).

Mesures pour percer le mur
(en millimètres).

10

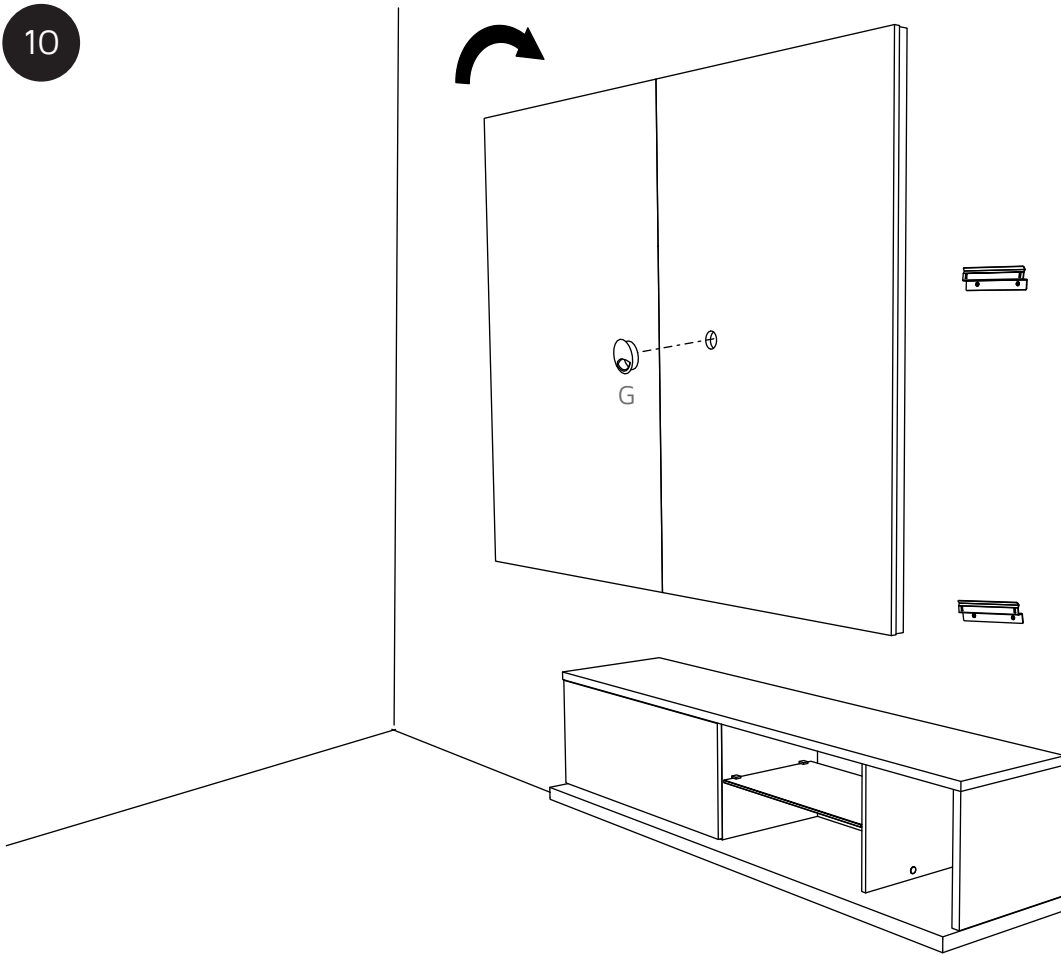

ATTENTION / ATENCIÓN / ATTENTION
Pass the cables through the back before Panel.
Lleve el cables antes de encajar el panel.
Acheminez les câbles avant de fixer le panneau.

