



INSTRUCTIONS D'ASSEMBLAGE
ASSEMBLY INSTRUCTIONS

MONARCH
SPECIALTIES INC.

I 3649

ETAGERE -
60" H / NOIR / METAL NOIR EN COIN

BOOKCASE -
60" H / BLACK / BLACK METAL CORNER ETAGERE





**POUR DE L'ASSISTANCE OU POUR COMMANDER
DES PIÈCES CONTACTEZ NOTRE DÉPARTEMENT
DE SERVICE À LA CLIENTÈLE.**

**FOR ASSISTANCE OR TO ORDER PARTS
CONTACT OUR CUSTOMER SERVICE DEPARTMENT**

WWW.MONARCHSERVICE.COM

LISTE DES PIÈCES
PARTS LIST

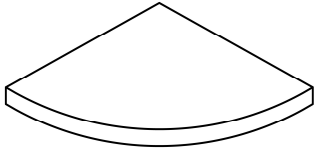
PIÈCE / PART #	IMAGE	DESCRIPTION	QTY / QTÉ
1		<p align="center">FRONT FACING LEFT LEG PATTE AVANT GAUCHE</p>	1
2		<p align="center">FRONT FACING RIGHT LEG PATTE AVANT DROITE</p>	1
3		<p align="center">SHELF ÉTAGÈRE</p>	4

LISTE DES PIÈCES DE MONTAGE
HARDWARE LIST

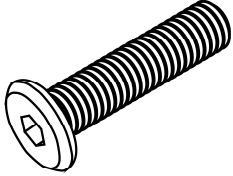
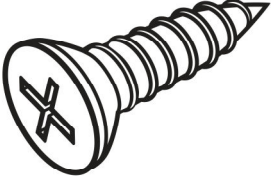
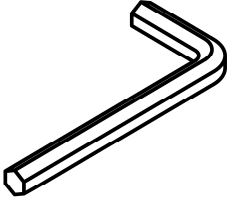
PIÈCE / PART #	IMAGE	DESCRIPTION	QTY / QTÉ
A		ASSEMBLING BOLT - Ø 1/4 X 1 1/4" BOULON D'ASSEMBLAGE - Ø 1/4 X 1 1/4"	3
B		ASSEMBLING SCREW - Ø 1/8 X 1/2" VIS D'ASSEMBLAGE - Ø 1/8 X 1/2"	16
C		HEX KEY CLÉ HEXAGONALE	1



OUTIL DE VÉRIFICATION DE DIMENSIONS DES PIÈCES
HARDWARE DIMENSIONS VERIFICATION TOOL

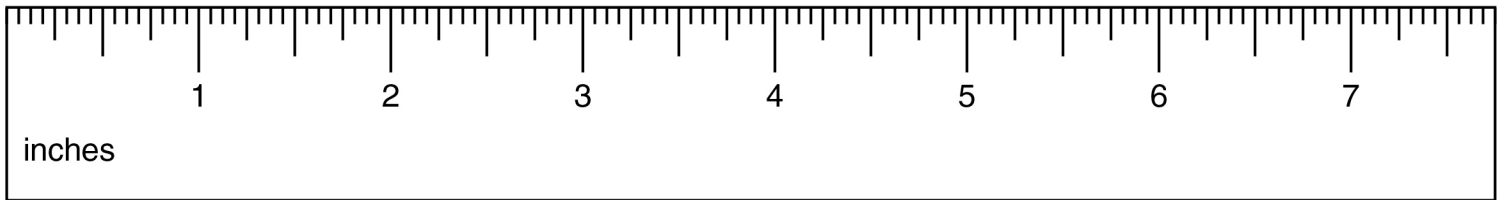

ÉTAPE / STEP 1

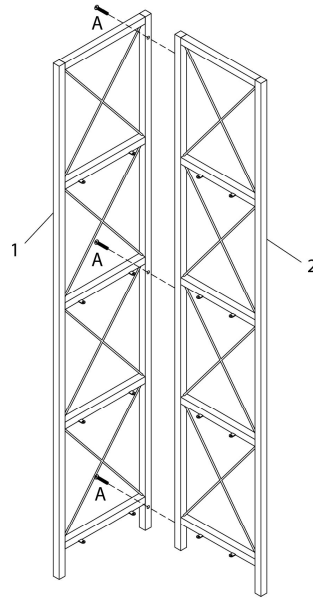

ÉTAPE / STEP 2

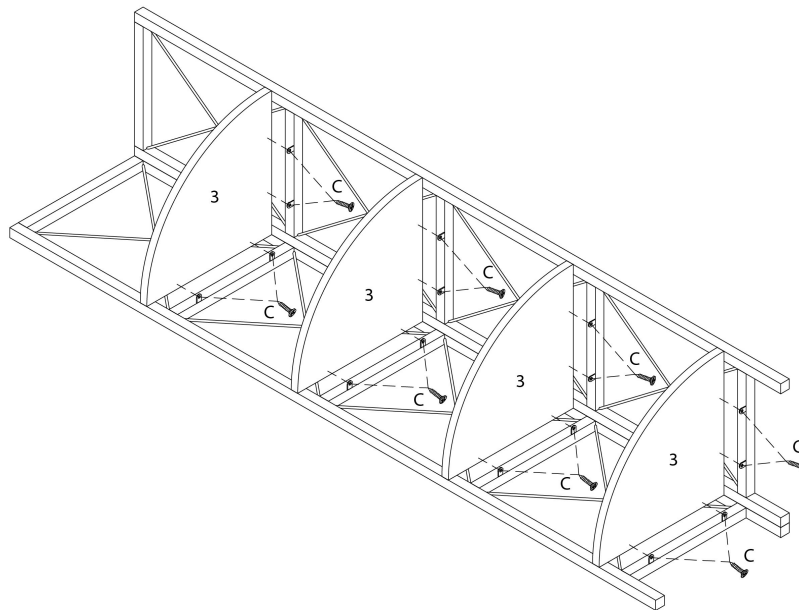

ÉTAPE / STEP 3

