

HOME SOURCE®

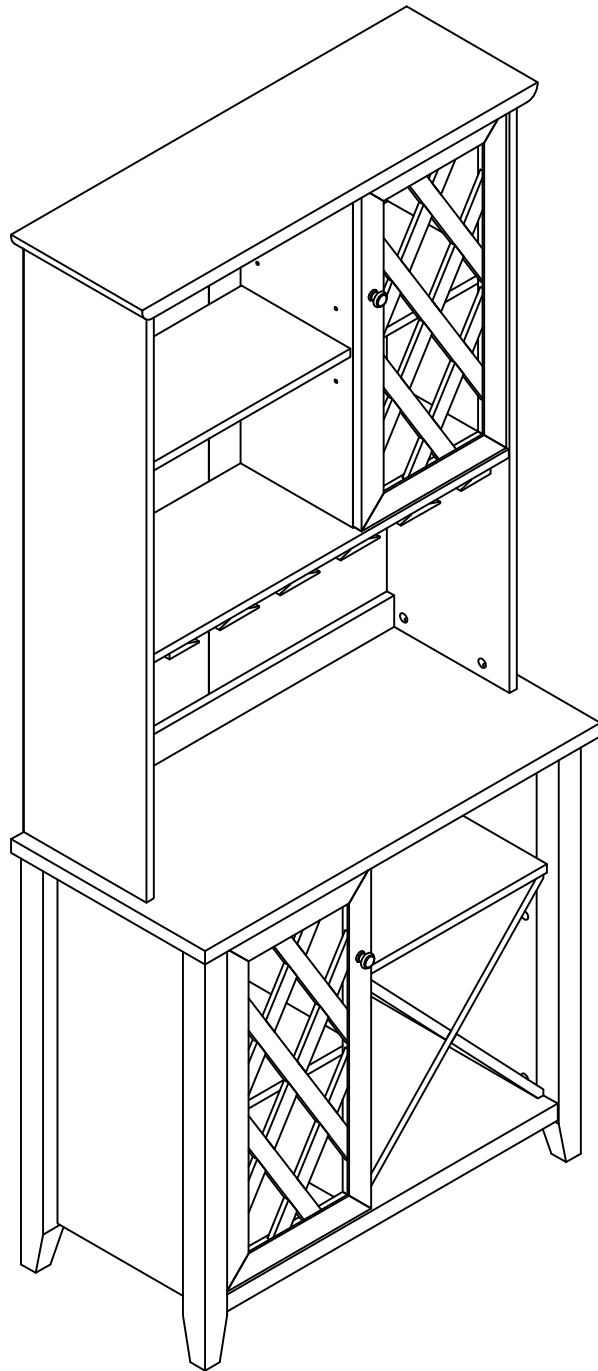

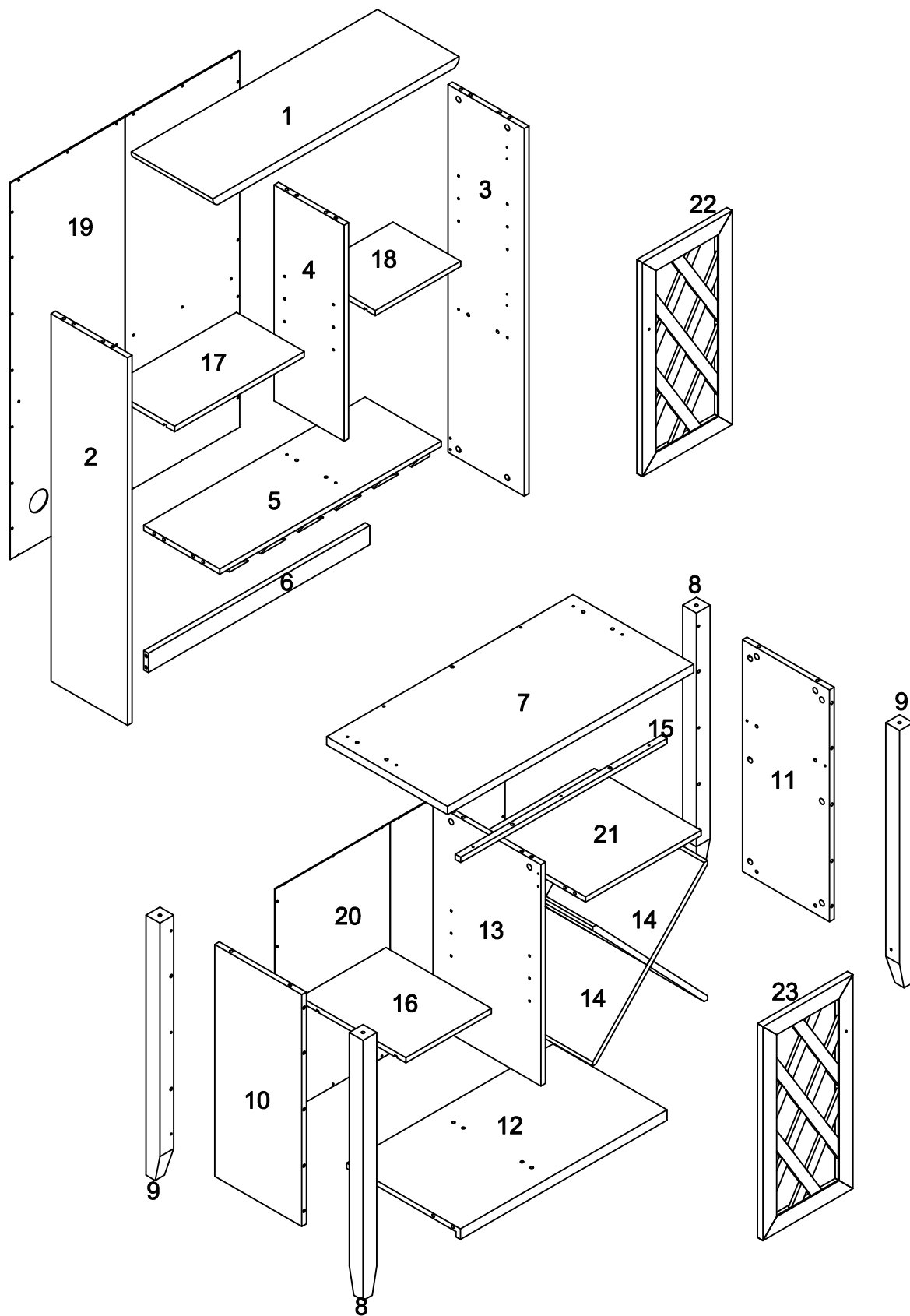















ASSEMBLY INSTRUCTION
MODEL:DC11 MOP



Parts List



Hardware List

A		Ø5*25mm	Bolt	48 pcs
B		Ø15*11mm	Nut	48 pcs
C		Ø8*30mm	Wood Dowel	43 pcs
D		Ø5*16mm	Shelf Support	12 pcs
E		Ø26mm	Hinge	4 pcs
F		Ø4*15mm	Screw	16 pcs
G		44x16x12mm	Magnet	2 pcs
H		Ø3.5*15mm	Screw	4 pcs
I		30x22x1mm	Iron Sheet	2 pcs
J		Ø2*12mm	Screw	2 pcs
K		Ø6*50mm	Bolt	2 pcs
L		M4	Allen Key	1 pc
M		Ø4*25mm	Screw	3pcs
N		Ø31*25mm	Handle	2 pcs
O		Ø4*24mm	Bolt	2 pcs
P		Ø3*15mm	Screw	48 pcs
Q			Glue	1 pc
R			Paper Cover	10 pcs
S			Anti-Tipping Kit	2 sets

Step 1

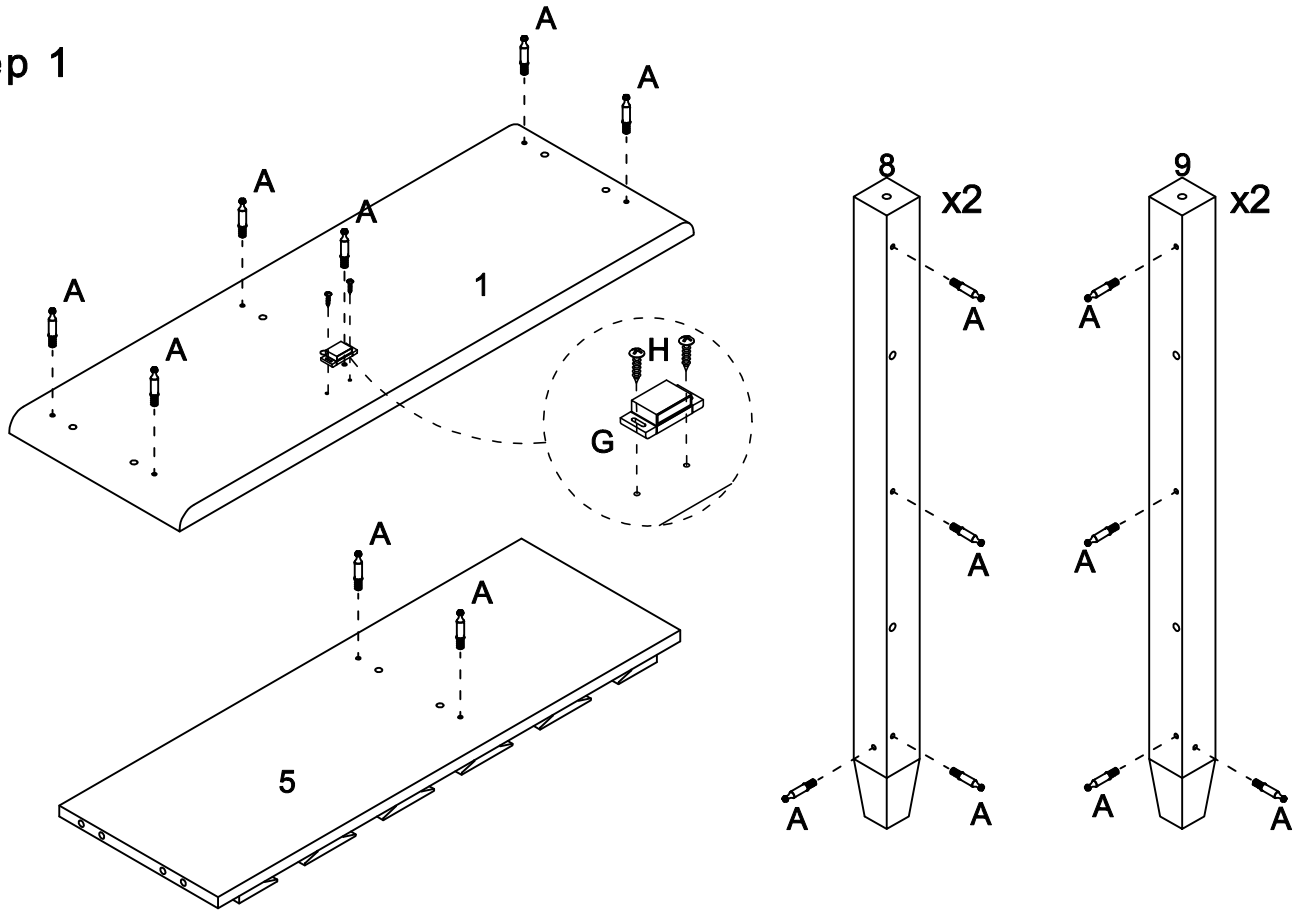

Step 2

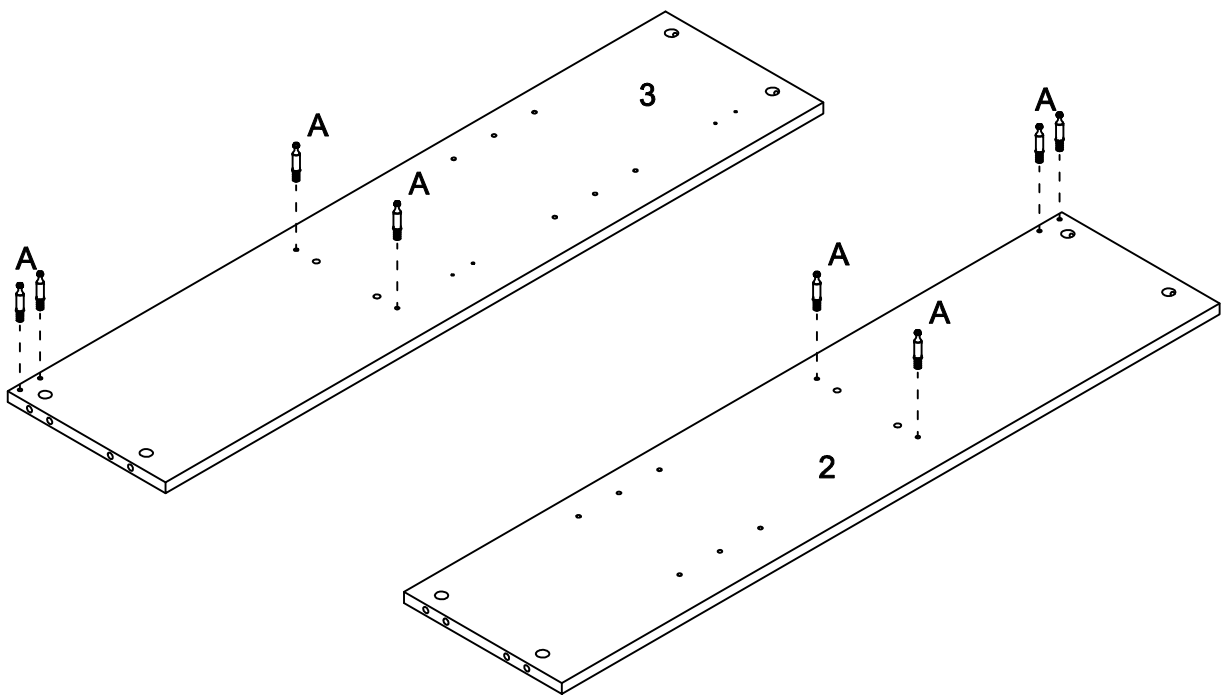

Step 3

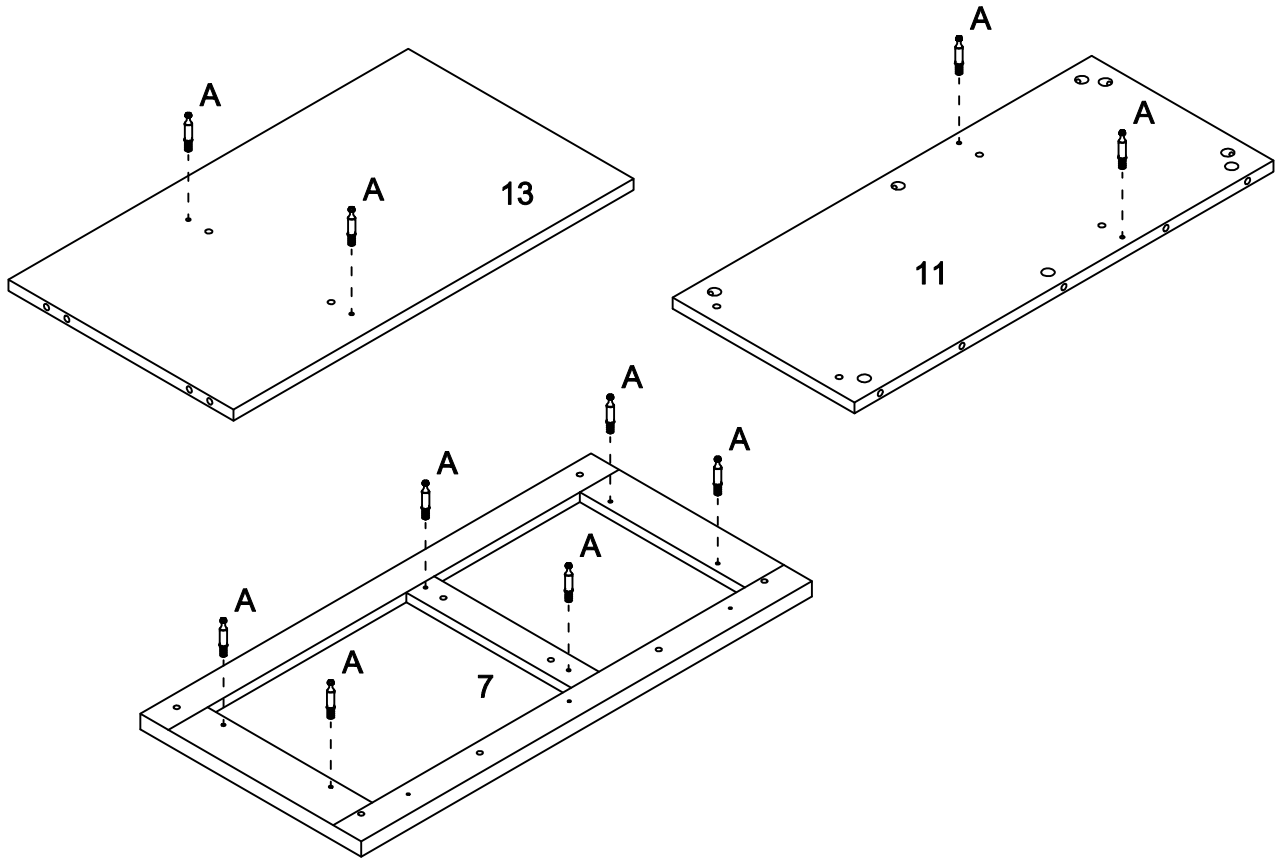

Step 4

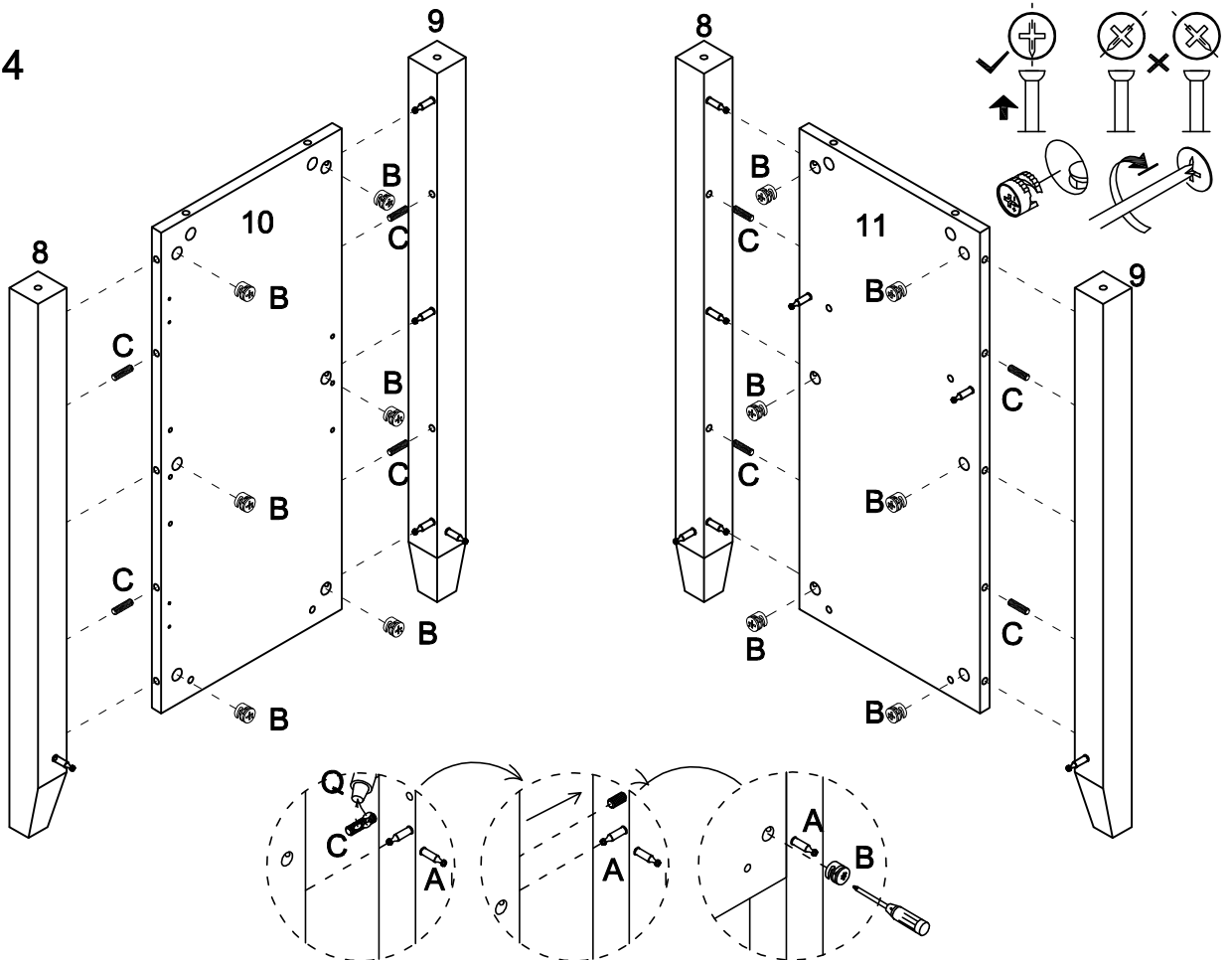

Step 5

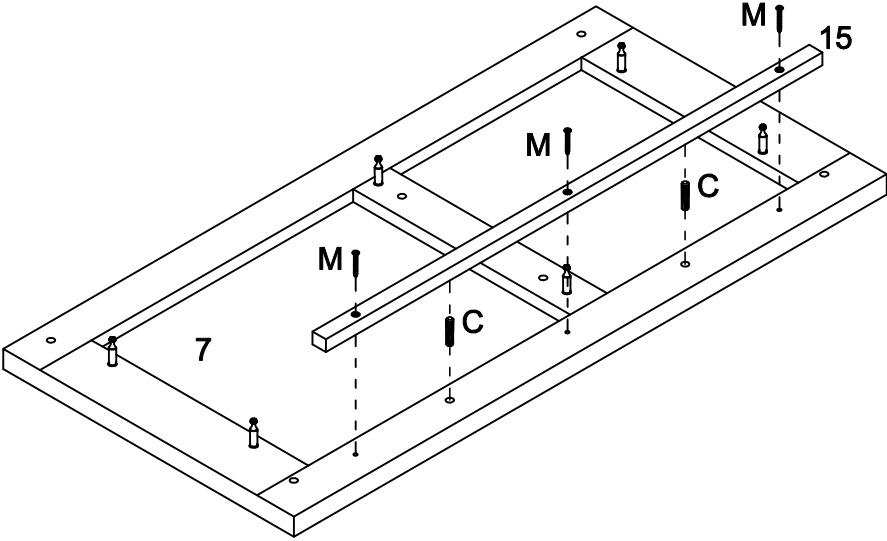

Step 6

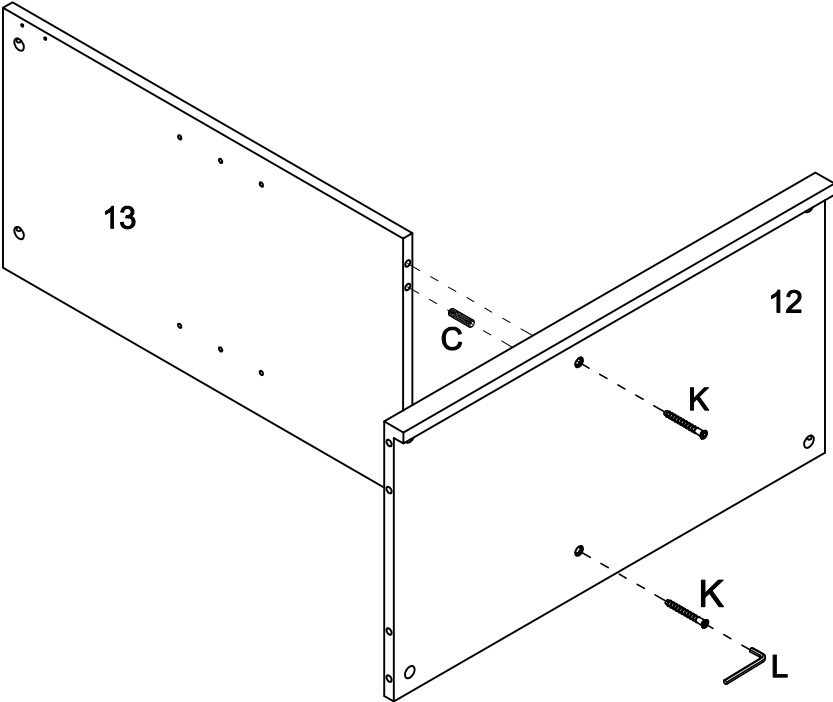

Step 7

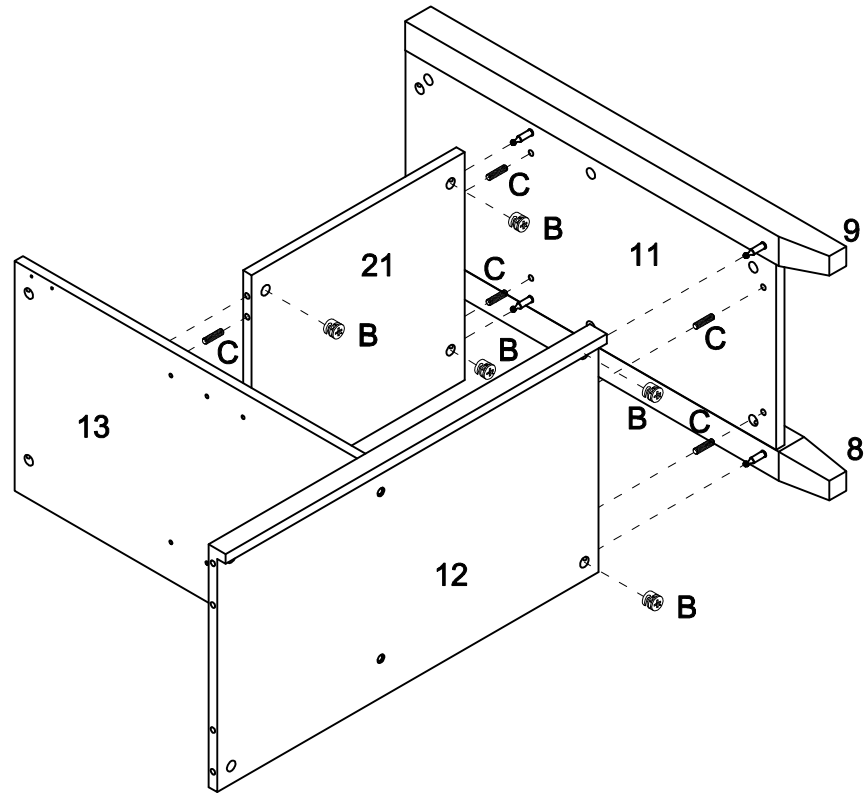

Step 8

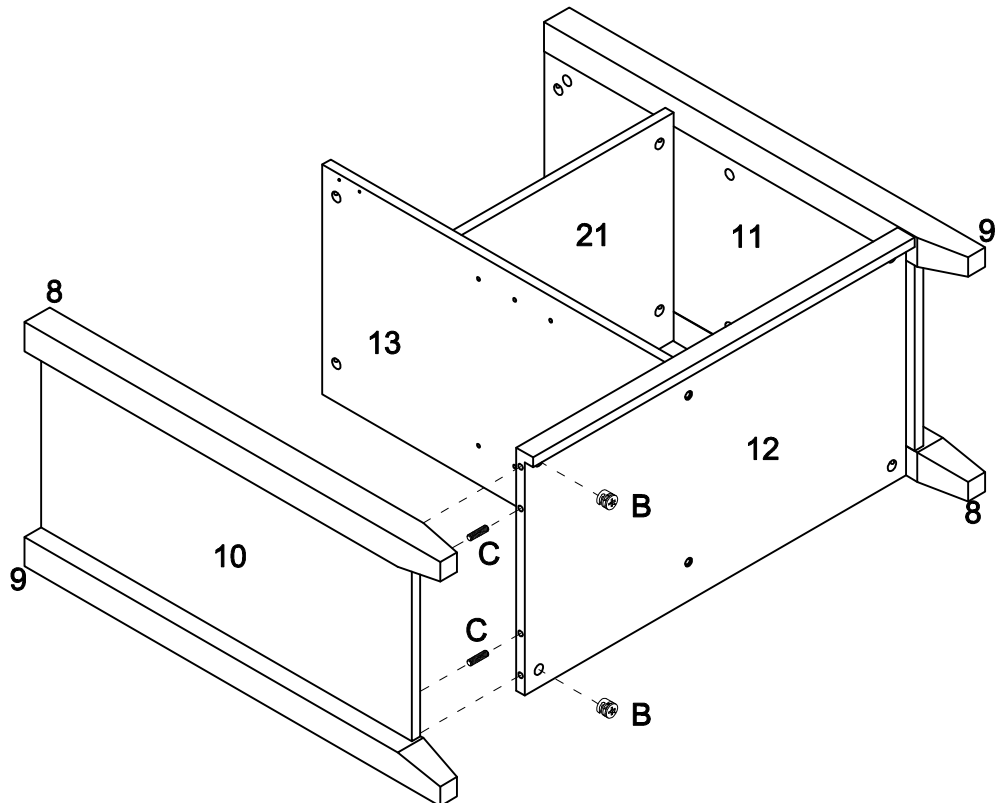

Step 9

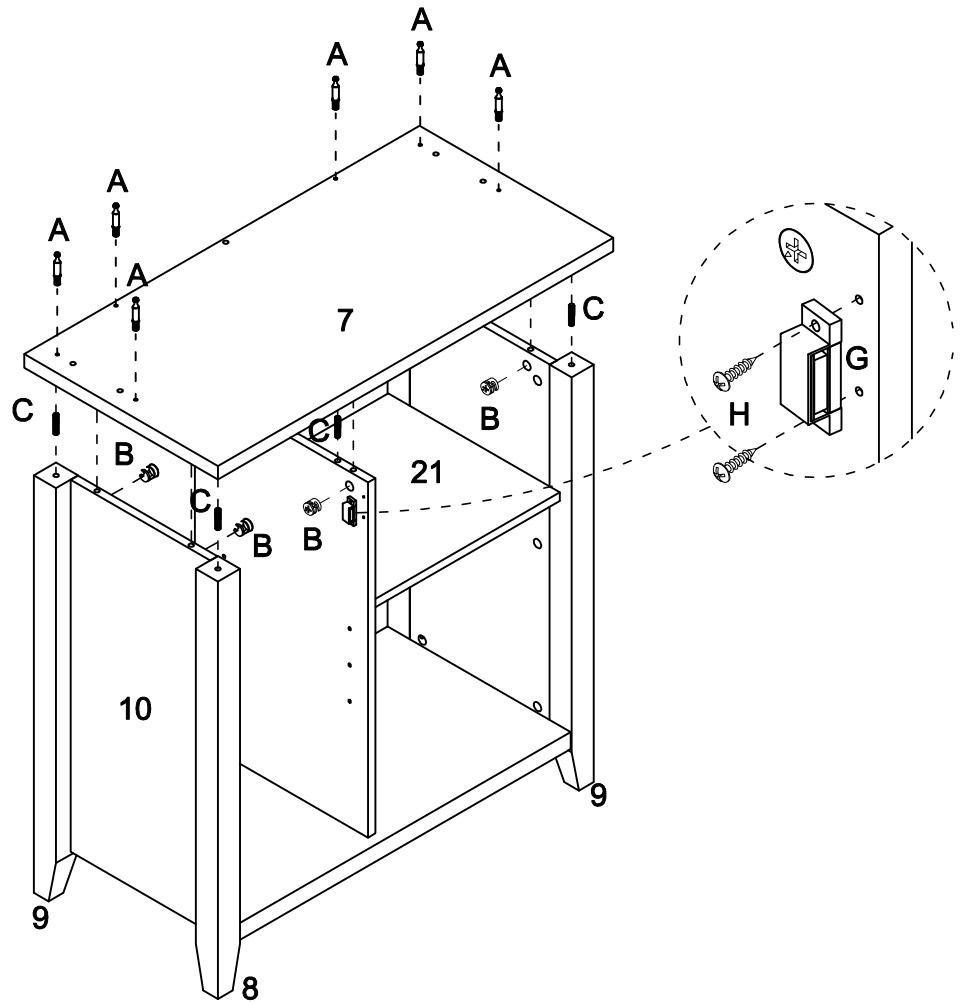

Step 10

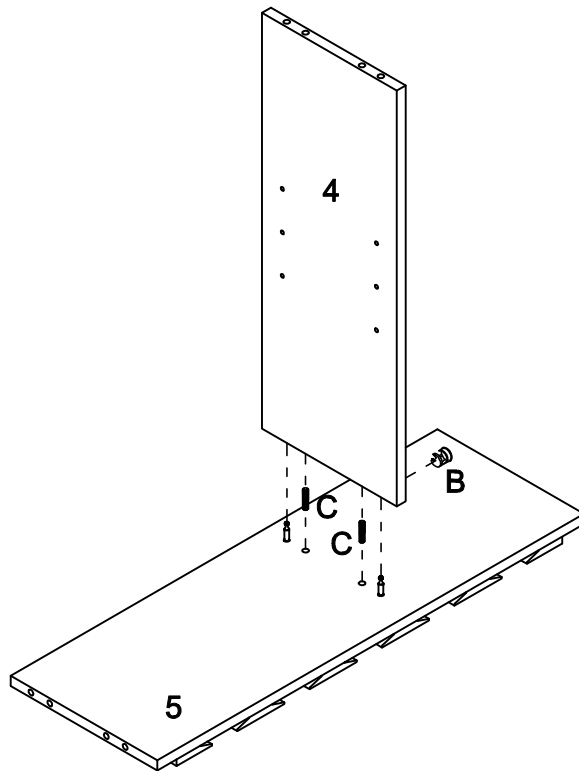

Step 11

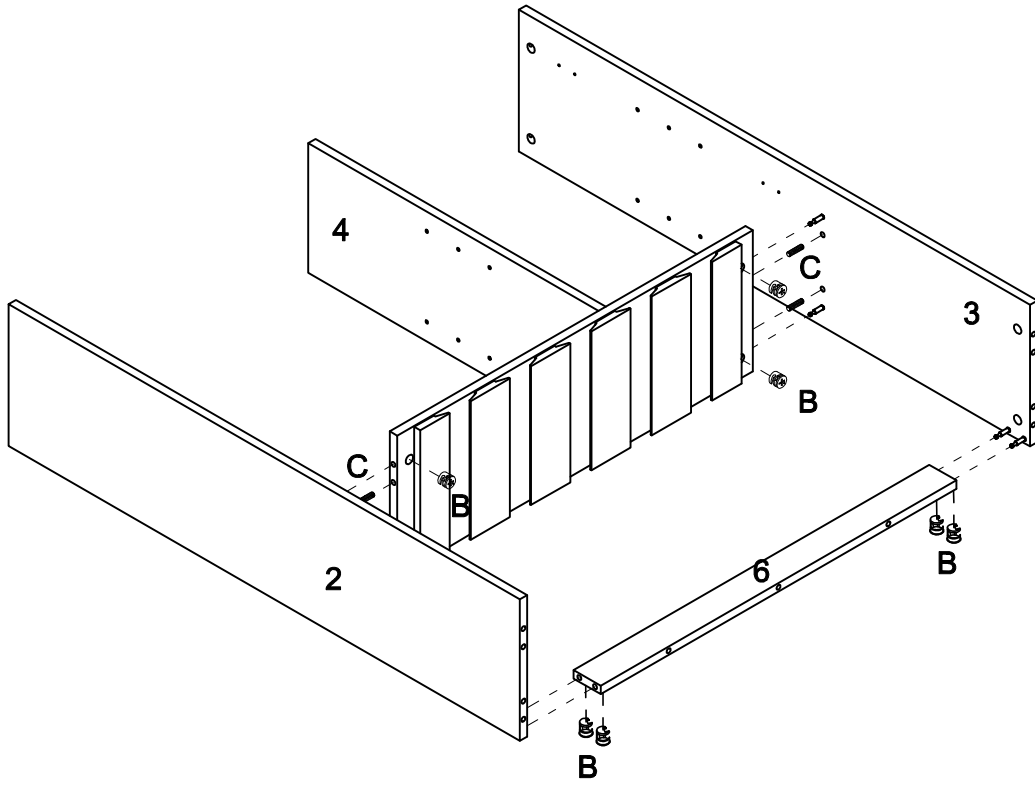

Step 12

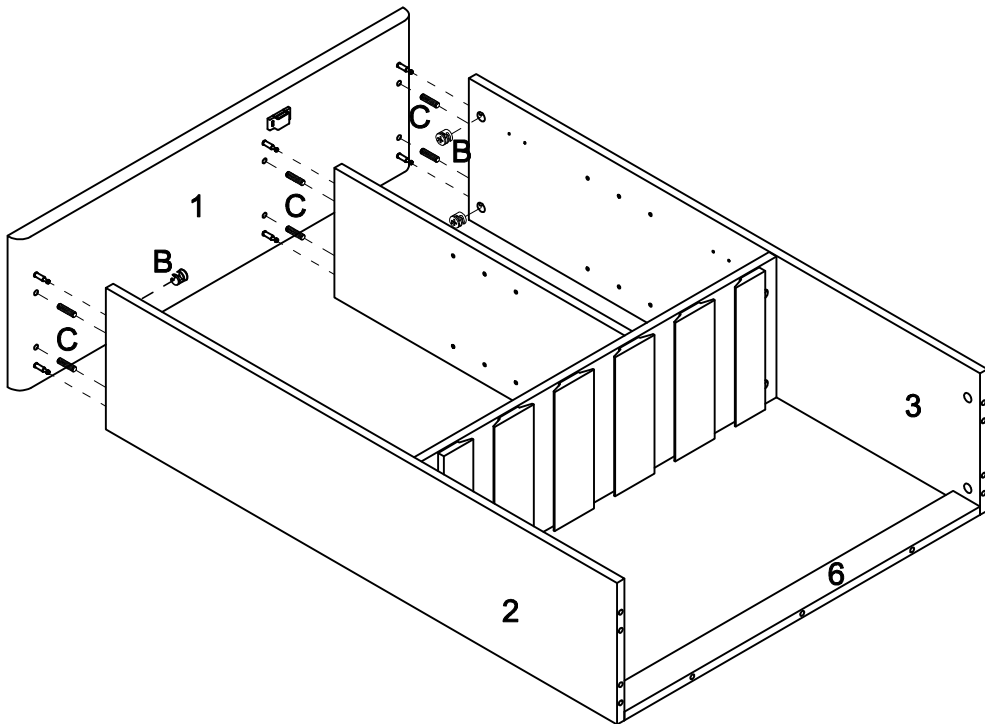

Step 13

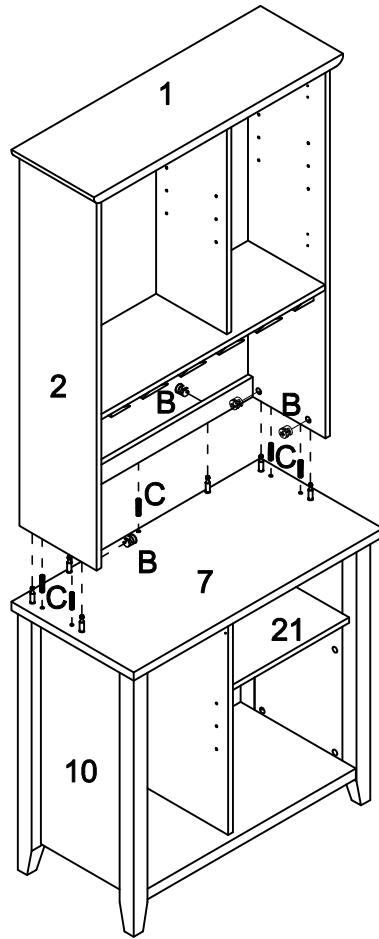

Step 14

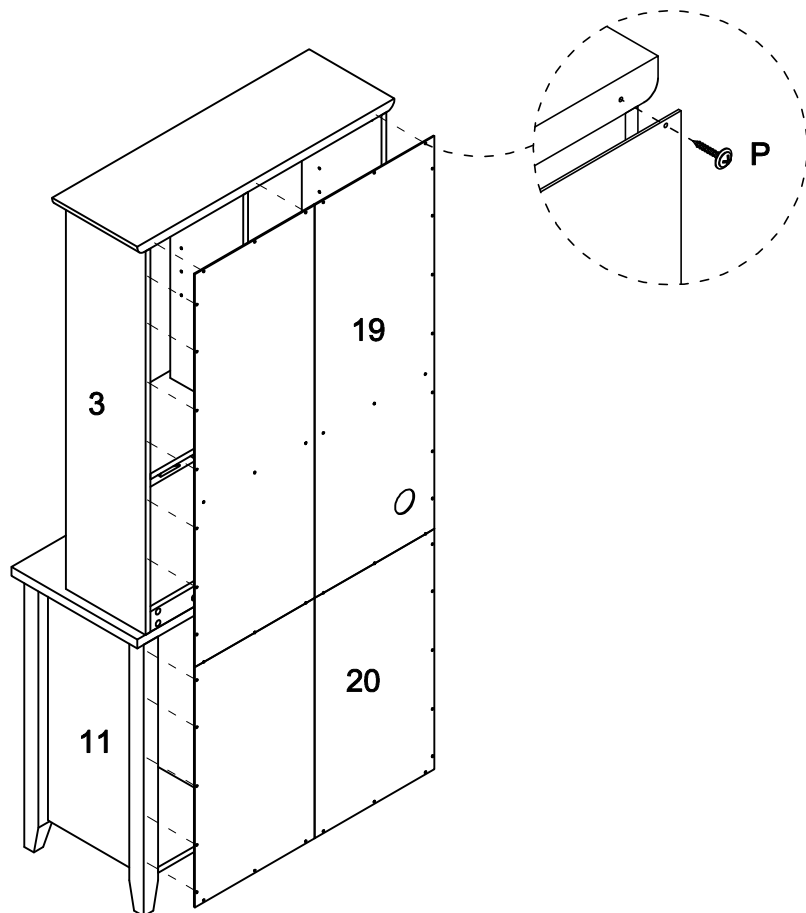

Step 15

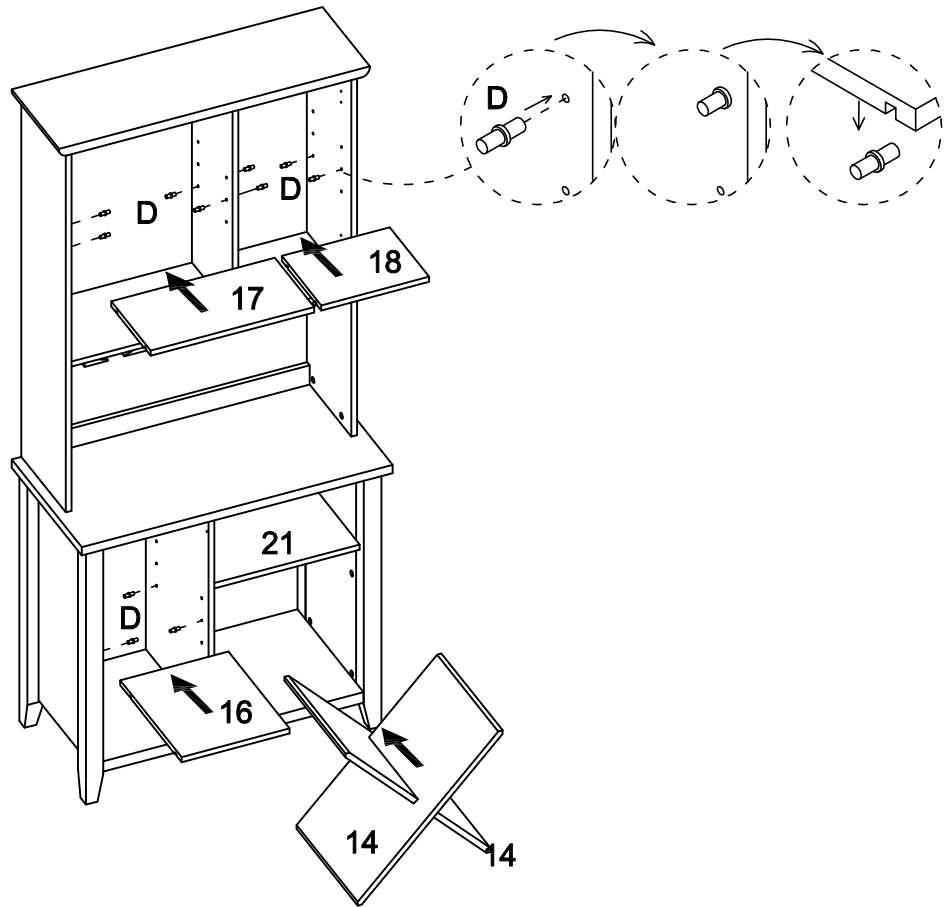

Step 16

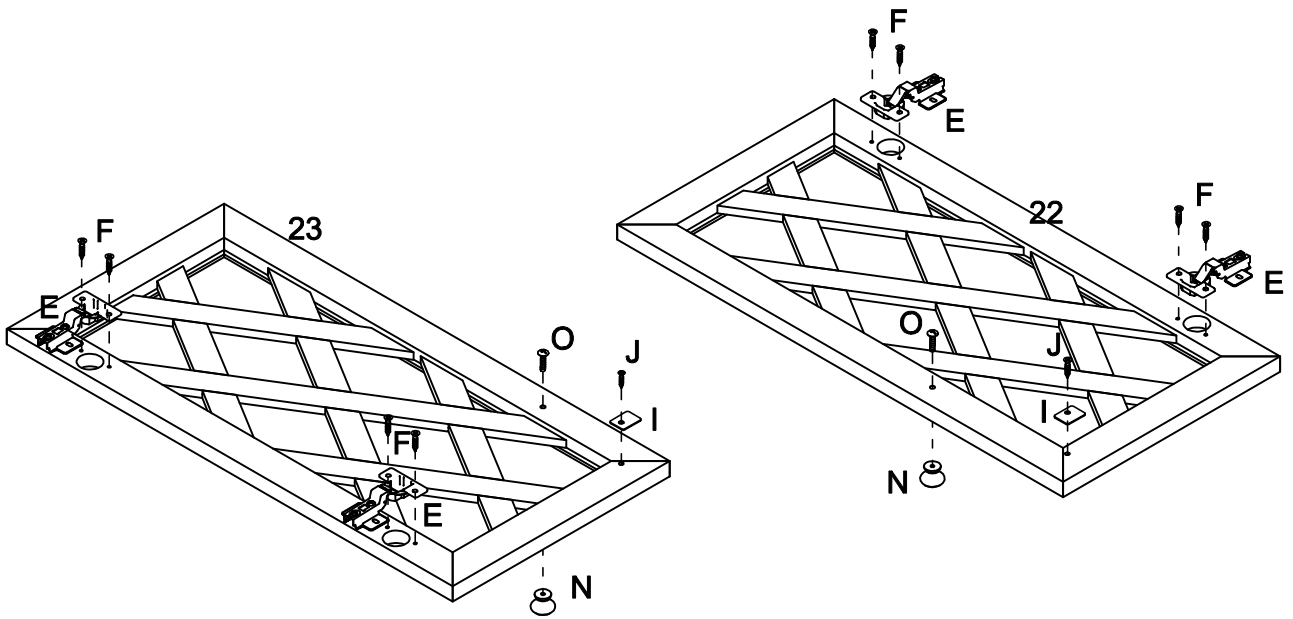

Step 17

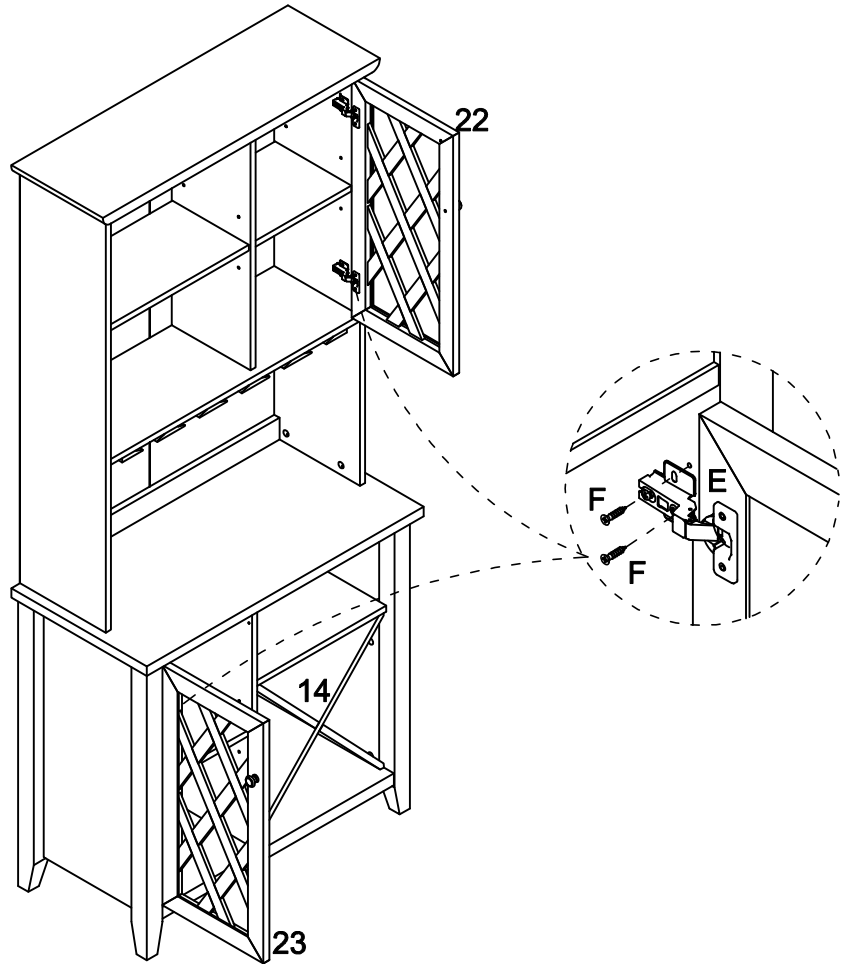

Step 18

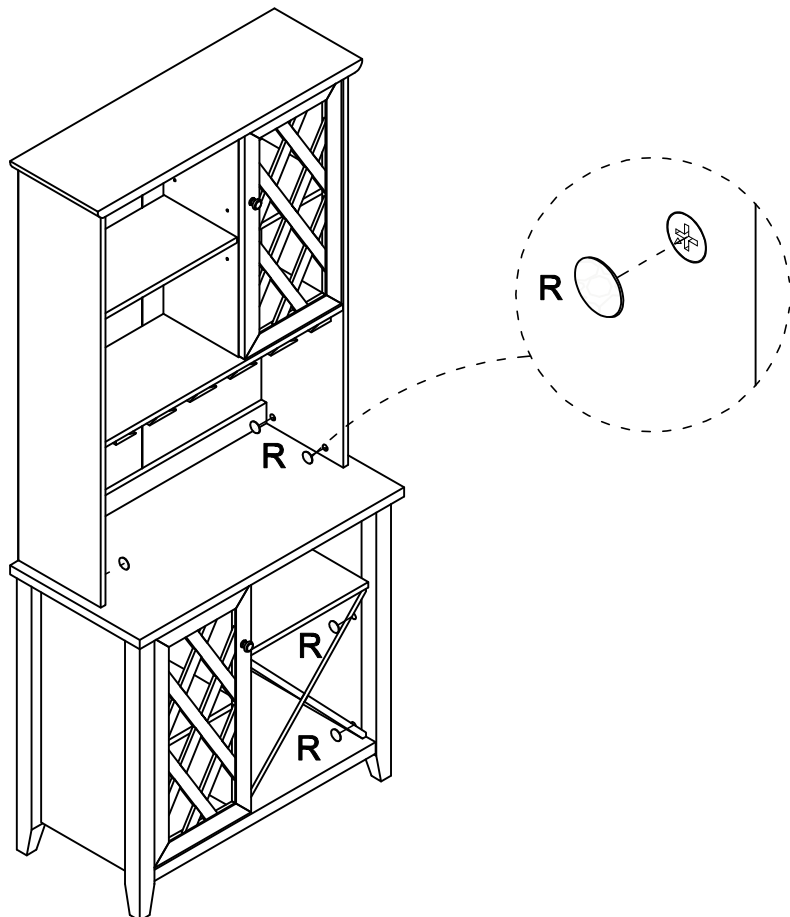

Step 19

