



**INSTRUCTIONS D'ASSEMBLAGE**  
**ASSEMBLY INSTRUCTIONS**

---

**M**ONARCH  
SPECIALTIES INC.

**I 7294**

---

**CHAISE DE BUREAU -**  
**BLANC / MECHE GRIS / MULTIPLE POSITION**

**OFFICE CHAIR -**  
**WHITE / GREY MESH / MULTI POSITION**





**POUR DE L'ASSISTANCE OU POUR COMMANDER**  
**DES PIÈCES CONTACTEZ NOTRE DÉPARTEMENT**  
**DE SERVICE À LA CLIENTÈLE.**

**FOR ASSISTANCE OR TO ORDER PARTS**  
**CONTACT OUR CUSTOMER SERVICE DEPARTMENT**

**WWW.MONARCHSERVICE.COM**

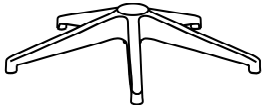
**LISTE DES PIÈCES**  
**PARTS LIST**

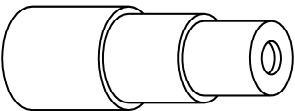
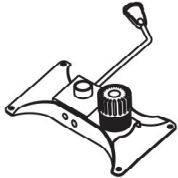
PIÈCE / PART #	IMAGE	DESCRIPTION	QTY / QTÉ
1		CASTOR ROULLETTE	5
2		BASE BASE	1
3		GASLIFT ASCENSEUR À ESSENCE	1
4		TELESCOPIC COLUMN COVER COUVERTURE DE COLONNE TÉLÉSCOPIQUE	1
5		CHAIR MECHANISM SEAT PLATE MÉCANISME DE SIÈGE	1

**LISTE DES PIÈCES**  
**PARTS LIST**

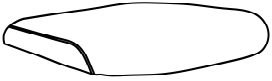
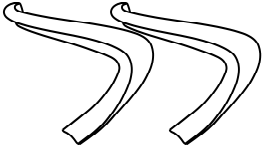
PIÈCE / PART #	IMAGE	DESCRIPTION	QTY / QTÉ
6		<p align="center"><b>BACK REST</b> <b>DOSSIER</b></p>	1
7		<p align="center"><b>SEAT CUSHION</b> <b>COUSSIN DU SIÈGE</b></p>	1
8		<p align="center"><b>ARM REST</b> <b>ACCOUDOIR</b></p>	2

**LISTE DES PIÈCES DE MONTAGE**  
**HARDWARE LIST**

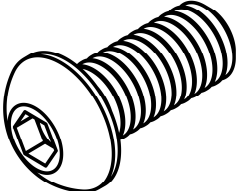
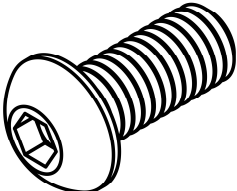
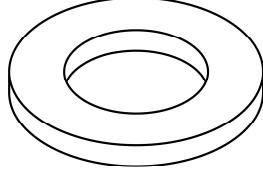
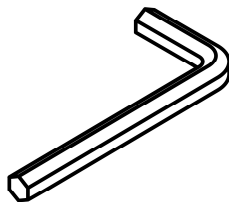
PIÈCE / PART #	IMAGE	DESCRIPTION	QTY / QTÉ
A		<p align="center">ASSEMBLING BOLT -            Ø 1/4" X 3/4"            BOULON D'ASSEMBLAGE -            Ø 1/4" X 3/4"</p>	6
B		<p align="center">ASSEMBLING BOLT -            Ø 1/4" X 1 1/4"            BOULON D'ASSEMBLAGE -            Ø 1/4" X 1 1/4"</p>	10
C		<p align="center">METAL WASHER            RONDELLE DE MÉTAL</p>	10
D		<p align="center">HEX KEY            CLÉ HEXAGONALE</p>	1



OUTIL DE VÉRIFICATION DE DIMENSIONS DES PIÈCES  
HARDWARE DIMENSIONS VERIFICATION TOOL



ÉTAPE / STEP 1

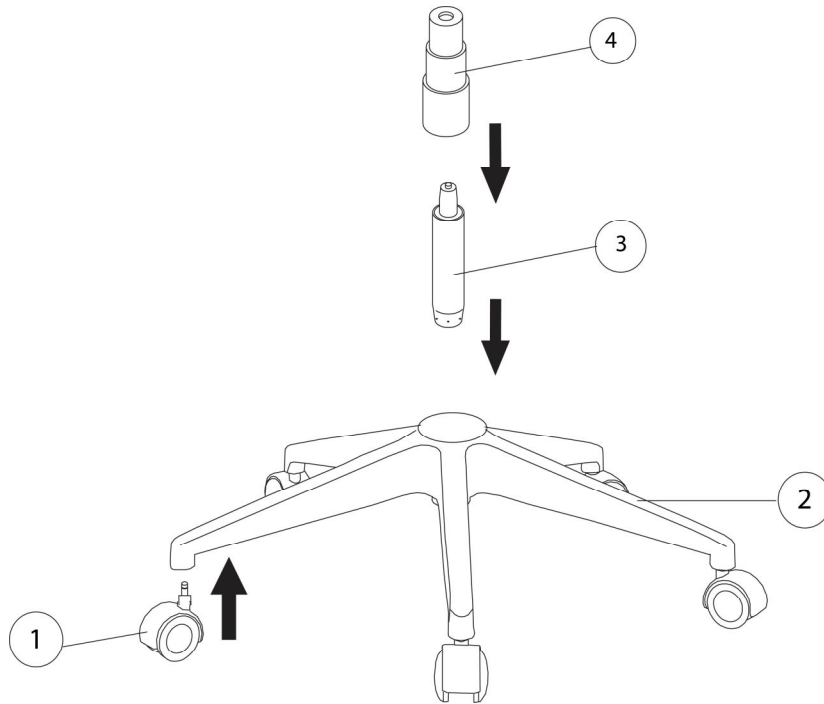

ÉTAPE / STEP 2

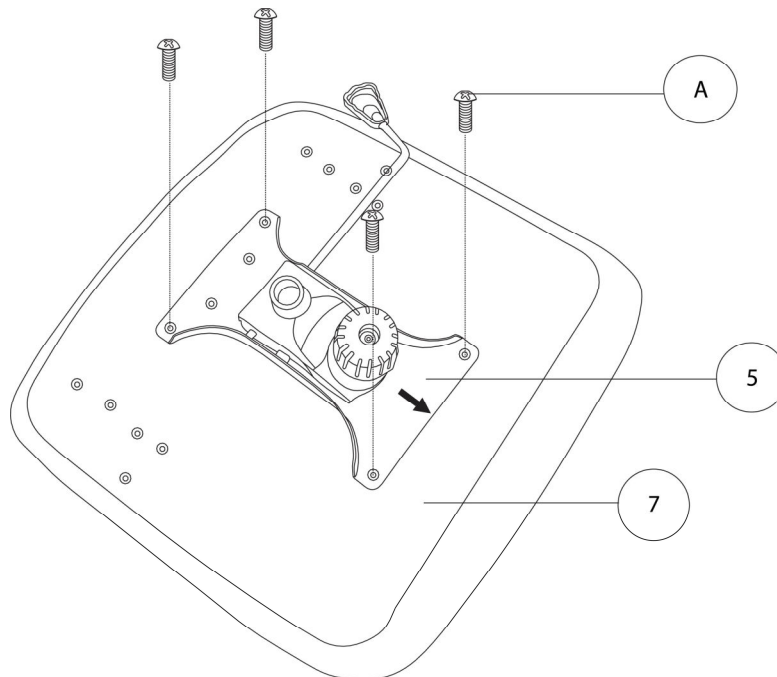

ÉTAPE / STEP 3

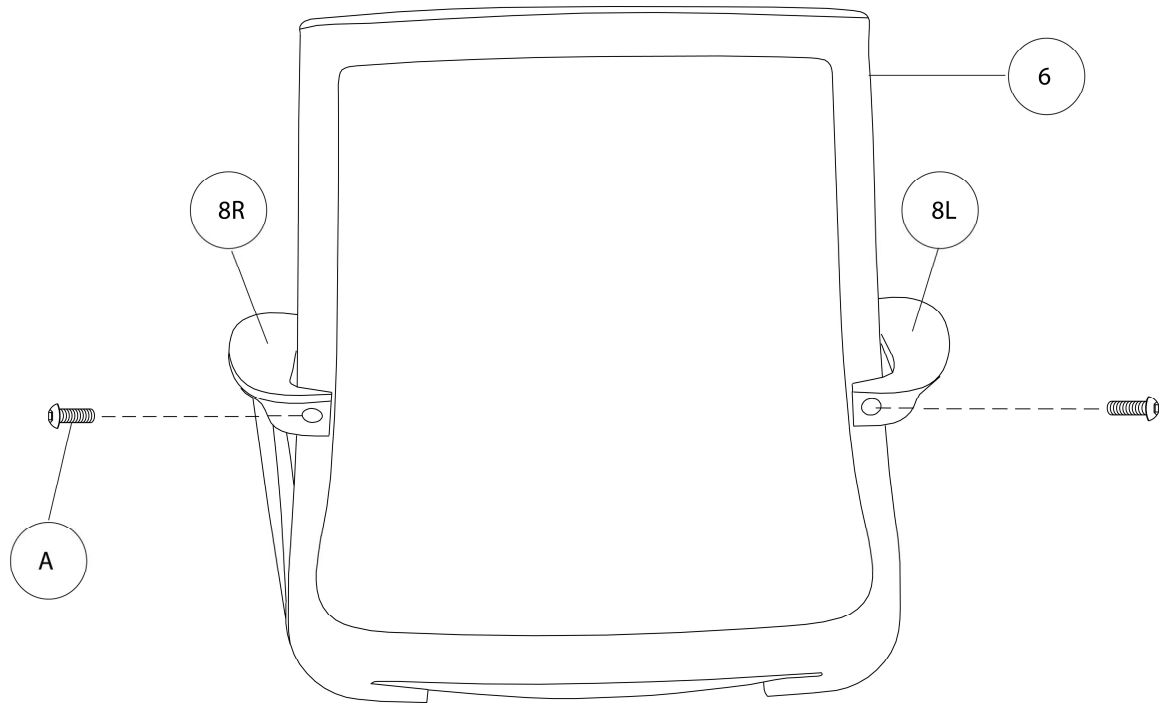

ÉTAPE / STEP 4

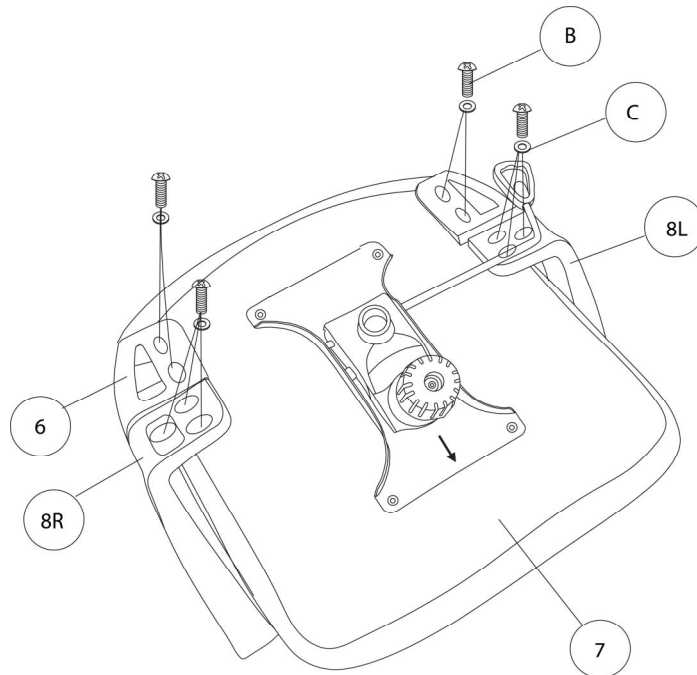

ÉTAPE / STEP 5

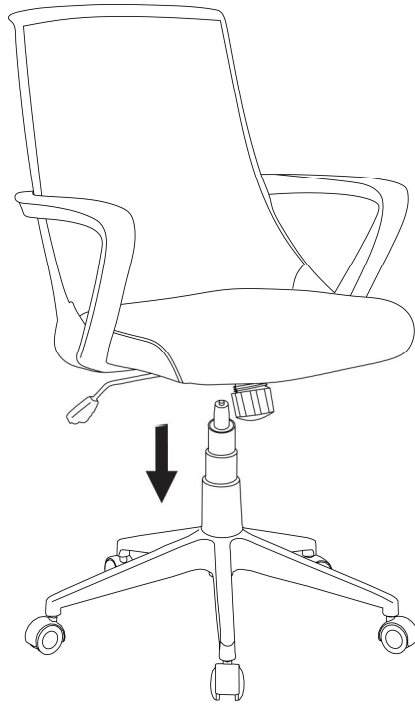



ÉTAPE / STEP 6

