



**INSTRUCTIONS D'ASSEMBLAGE
ASSEMBLY INSTRUCTIONS**

MONARCH
SPECIALTIES INC.

I 7300

**CHAISE DE BUREAU -
NOIR / TISSU NOIR / DOSSIER EXECUTIF**

**OFFICE CHAIR -
BLACK / BLACK FABRIC / HIGH BACK EXECUTIVE**





**POUR DE L'ASSISTANCE OU POUR COMMANDER
DES PIÈCES CONTACTEZ NOTRE DÉPARTEMENT
DE SERVICE À LA CLIENTÈLE.**

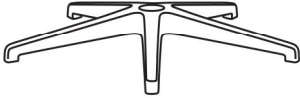

**FOR ASSISTANCE OR TO ORDER PARTS
CONTACT OUR CUSTOMER SERVICE DEPARTMENT**

WWW.MONARCHSERVICE.COM

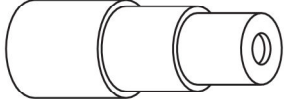
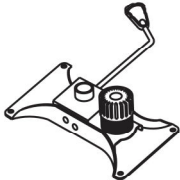
LISTE DES PIÈCES
PARTS LIST

PIÈCE / PART #	IMAGE	DESCRIPTION	QTY / QTÉ
1		<p align="center">CASTOR ROULLETTE</p>	5
2		<p align="center">BASE BASE</p>	1
3		<p align="center">GASLIFT ASCENSEUR À ESSENCE</p>	1
4		<p align="center">TELESCOPIC COLUMN COVER COUVERTURE DE COLONNE TÉLÉSCOPIQUE</p>	1
5		<p align="center">CHAIR MECHANISM SEAT PLATE MÉCANISME DE SIÈGE</p>	1

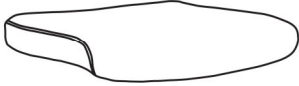
LISTE DES PIÈCES
PARTS LIST

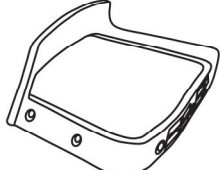
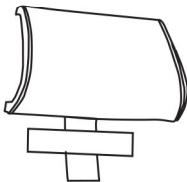
PIÈCE / PART #	IMAGE	DESCRIPTION	QTY / QTÉ
6		BACK REST DOSSIER	1
7		SEAT CUSHION COUSSIN DU SIÈGE	1
8		FRONT FACING LEFT ARMREST ACCOUDOIR AVANT GAUCHE	1
9		FRONT FACING RIGHT ARMREST ACCOUDOIR AVANT DROIT	1
10		HEADREST APPUI TÊTE	1

LISTE DES PIÈCES
PARTS LIST

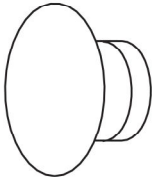
PIÈCE / PART #	IMAGE	DESCRIPTION	QTY / QTÉ
11		SCREW CAP CAPUCHON DE VIS	1
12		SCREW CAP CAPUCHON DE VIS	4

LISTE DES PIÈCES DE MONTAGE
HARDWARE LIST

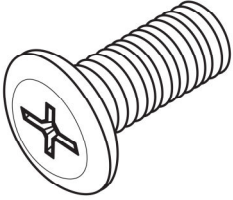
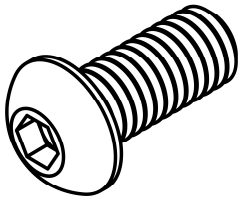
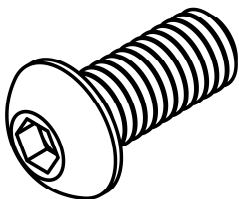
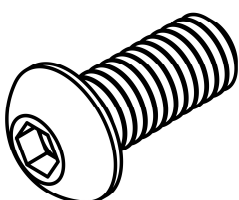
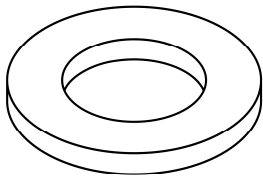
PIÈCE / PART #	IMAGE	DESCRIPTION	QTY / QTÉ
A		ASSEMBLING BOLT - Ø 1/4" X 1 1/4" BOULON D'ASSEMBLAGE - Ø 1/4" X 1 1/4"	2
B		ASSEMBLING BOLT - Ø 1/4" X 3/4" BOULON D'ASSEMBLAGE - Ø 1/4" X 3/4"	4
C		ASSEMBLING BOLT - Ø 1/4" X 1 1/4" BOULON D'ASSEMBLAGE - Ø 1/4" X 1 1/4"	6
D		ASSEMBLING BOLT - Ø 1/4" X 3/4" BOULON D'ASSEMBLAGE - Ø 1/4" X 3/4"	4
E		METAL WASHER - Ø 5/8" X 1/4" RONDELLE DE MÉTAL - Ø 5/8" X 1/4"	6

LISTE DES PIÈCES DE MONTAGE
HARDWARE LIST

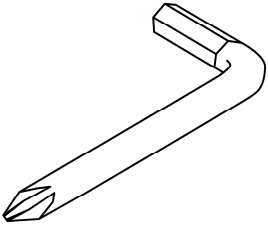
PIÈCE / PART #	IMAGE	DESCRIPTION	QTY / QTÉ
F		HEX KEY CLÉ HEXAGONALE	1

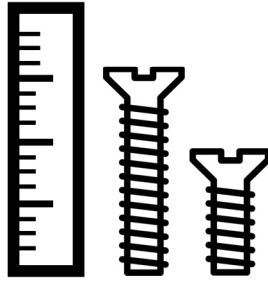

OUTIL DE VÉRIFICATION DE DIMENSIONS DES PIÈCES
HARDWARE DIMENSIONS VERIFICATION TOOL

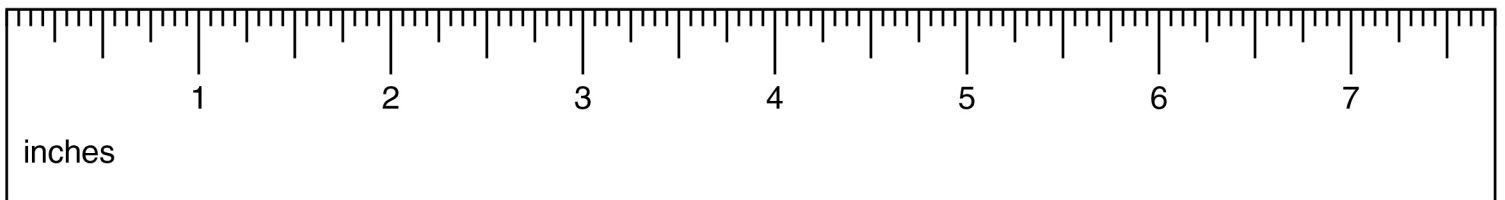

ÉTAPE / STEP 1

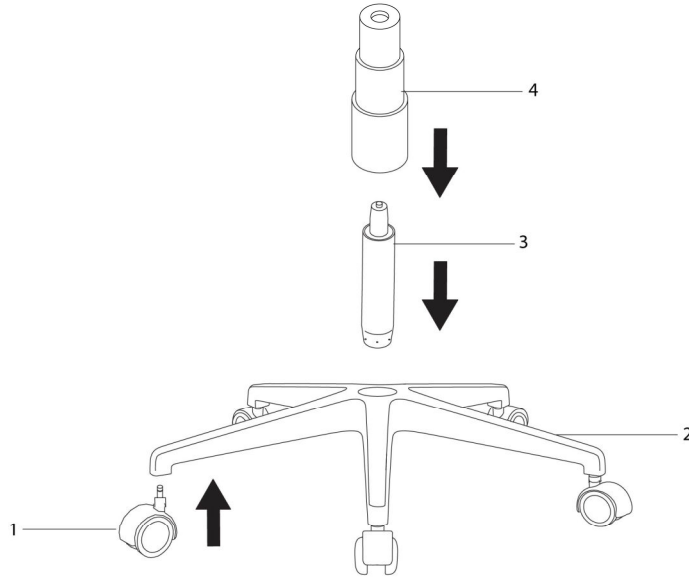

ÉTAPE / STEP 2

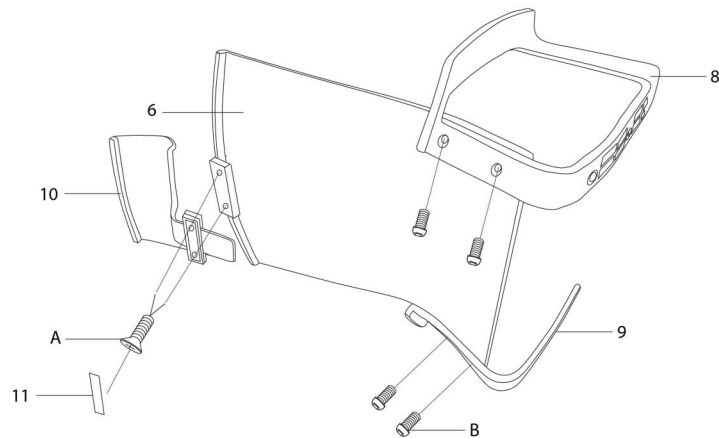

ÉTAPE / STEP 3

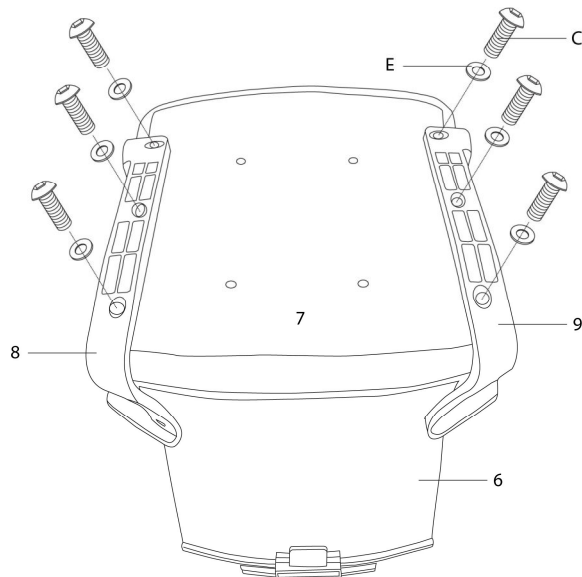

ÉTAPE / STEP 4

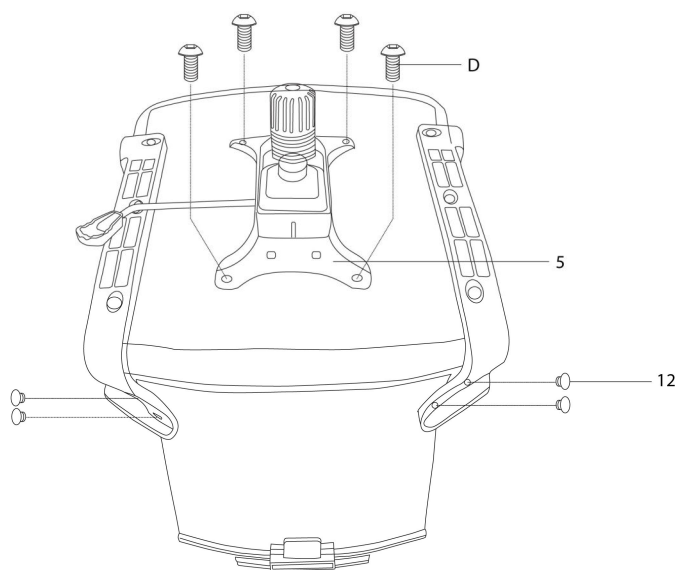

ÉTAPE / STEP 5

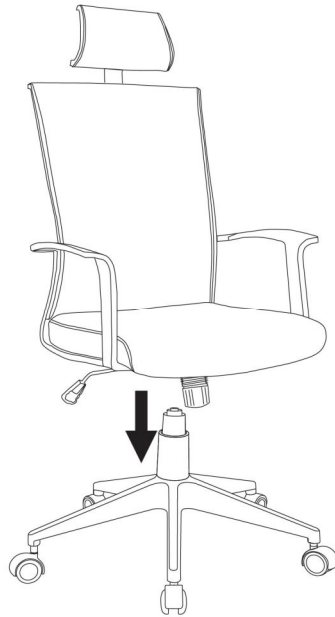

ÉTAPE / STEP 6

