







Assembly Instructions

ITEM NO.:48134/48135

Thank you for purchasing this quality product. Be sure to check all packing material carefully for small parts that may have come loose inside the carton during shipment.(Note:Loosely thread all screws/bolts first. Once the item is assembled then completely tighten.)

TOOLS REQUIRED				HARDWARE LIST:				
PARTS LIST:				No.	Sketch	Description	Size	Quantity
No.	Description	Sketch	Quantity	D		Flat Washer	φ5/16" x 3/4"	12
A	Talbe Top		1	E		Lock Washer	φ5/16"	12
B	leg		4	F		Bolt	φ5/16" x 1-3/4"	12
C	Shelf		1	G		Allen Wrench	φ5mm	1

STEP 1

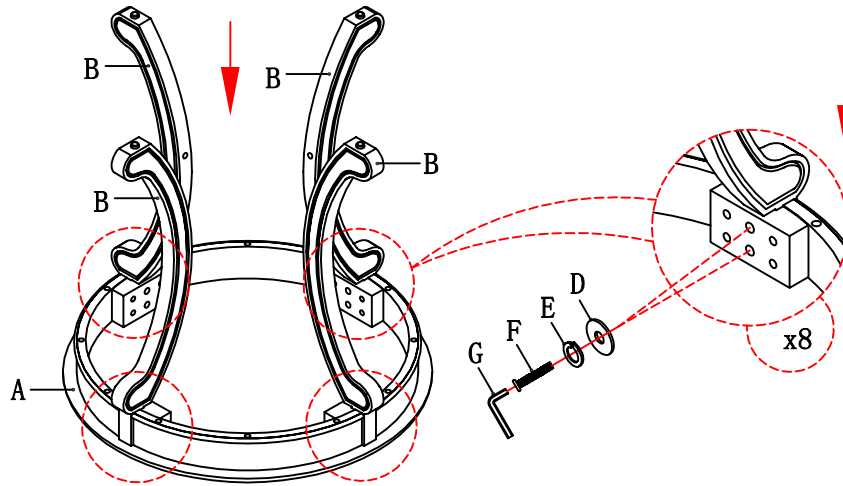

STEP 2

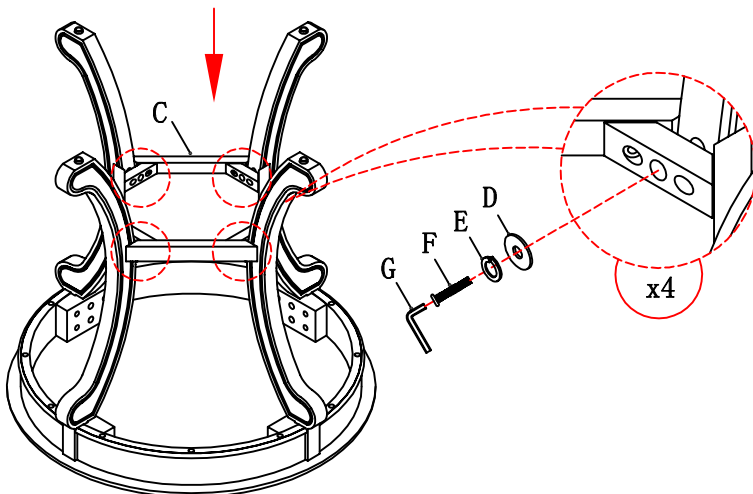

STEP 3

