











ROOMS

TO GO

SKU:22011299 ALEK 1129-2 RECTANGLE COCKTAIL TABLE ASSEMBLY INSTRUCTION

Thank you for purchasing this quality product. Be sure to check all packing material carefully for small parts which may have come loose inside the carton during shipment. Identify and count all parts and compare with the Parts list below:

No.	PART	DESCRIPTION	Q. TY
1		Allen Wrench: M4	1
2		Bol t: 1/4"*5/8"	8
4		Antiskid Pad	4
5		Pad	6
6		Leg	4
7		Top frame	1
8		Bottom frame	1
9		Bottom glass	1
10		Top glass	1
11		Metal cap	4

Step 1

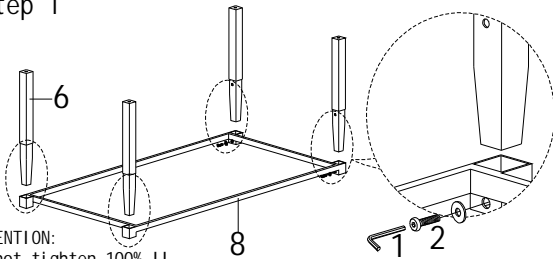

ATTENTION:
Do not tighten 100% !!
Tighten it 100% after step3

Step 2

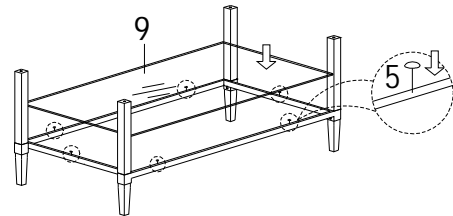

Step 3

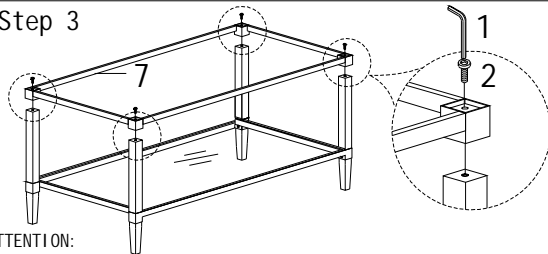

ATTENTION:
Do not tighten 100% !!
Tighten it 100% after step3

Step 4

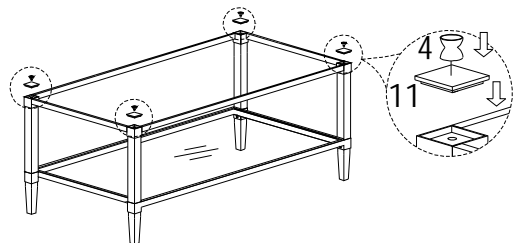

Step 5

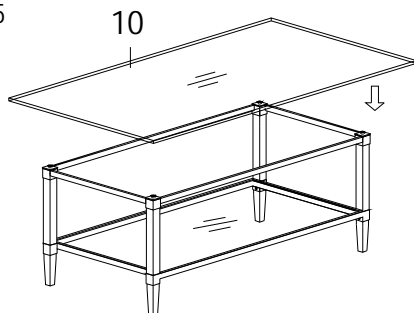

Step 6
Finish

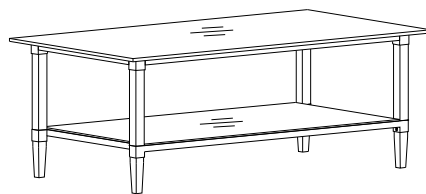

ASSEMBLY INSTRUCTION

- Carefully unwrap the furniture and place all parts on a clean soft blanket.
- Using Bolt(2), Allen Wrench(1) to assembly Leg(6) and Bottom frame(8) as step 1.
- Using Pad(5) to the Bottom frame(8), then put the Bottom glass(9) as step 2.
- Using Allen Wrench(1) and Bolt(2) to fasten the Top frame as step3.
- Using Antiskid Pad(4) and Metal Cap(11) to the Top frame as step4.
- Put the Top glass(10) to the Top frame(7) as step5.
- Enjoy your table for a long time to come.

MADE IN CHINA