

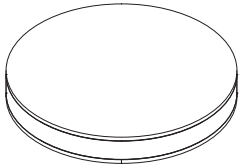
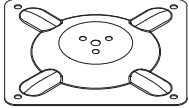

Thank you for purchasing this product. Be sure to check all packing material carefully for small parts which may have come loose inside the carton during shipment. Identify and count all parts and compare with the HARDWARE LIST below.

Caution: Please read all instructions carefully before starting the assembly process. These parts are cumbersome and heavy. Therefore, two people are recommended in order to prevent personal injury and insure the parts are not damaged during the assembly.

PARTS LIST

			
A. TOP TABLE - 1PC	B. SQUARE BRACKET - 1PC	C. ROUND PILLAR =1PC	D. BOTTOM ROUND BASE=1PC

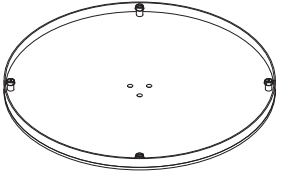
NO.	HARDWARE LIST		Q'TY
1		BOLT 5/16*18*28mm	6 PCS
		SPRING WASHER 5/16*Ø14*1.5mm	
		FLAT WASHER 5/16*Ø19*2mm	
2		BOLT 1/4*20*15mm	4 PCS
		SPRING WASHER 1/4*Ø12*1.5mm	
		FLAT WASHER 1/4*Ø16*2mm	
3		ALLEN KEY M4	1 PC

Hardware pack locations:
 5152-CKT Round Cocktail Table -sku#:22151524

Note: Do not tighten all screws & Bolts until the table is fully assembly.

STEP 1: Assemble the Square Bracket (B) to the Round Pillar (C) by bolt (1) and tighten with Allen key (3).

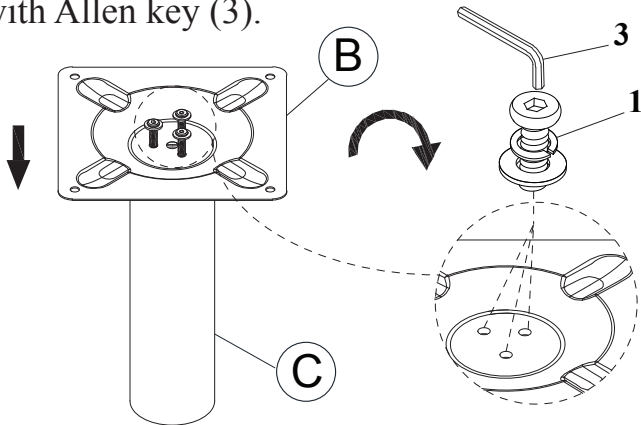

STEP 2: Assemble the STEP 1 to the Top table (A) by bolt (1) and tighten with Allen key (3).

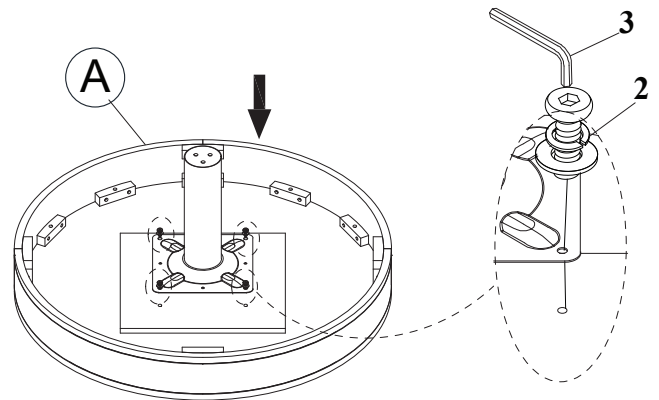

STEP 3: Assemble the Bottom round table by bolt (2) and tighten with Allen key (3).

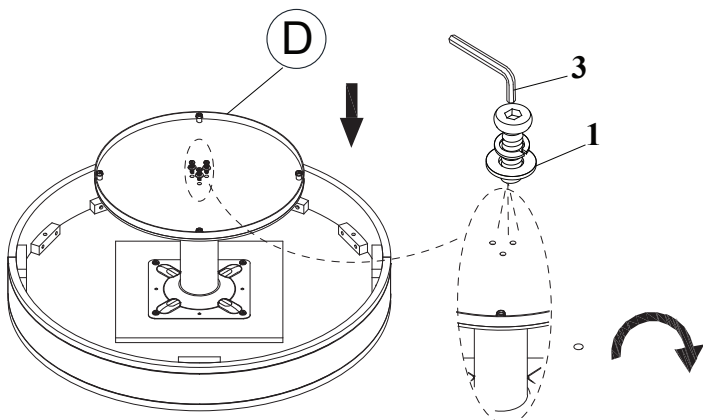

STEP 4:

