













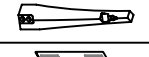

841T-1 Cocktail Table Assembly Instructions

Thank you for purchasing this quality product. Be sure to check all packing materials carefully for small parts which may have come loose inside the carton during shipment. Identify and count all parts and compare with the parts list below.

** Assemble the product on a flat, soft surface such as a carpet or cloth to prevent scratching the finish. Read all instruction and study the drawings carefully before starting the assembly process.

NO.	SKETCH	DESCRIPTION	Q'TY
A		Top frame	1pc
B		Plaque	1pc
C		Glass	1pc
D		Mirror	1pc
E		Lower frame	1pc
F		Feet	4pcs
G		Wood cap	4pcs

NO.	SKETCH	HARDWARE	Q'TY
a		5/16"x18x2"	8 pcs
b		5/16"x12x1(T)	8 pcs
c		5/16"x19x2(T)	8 pcs
d		4mm	1 pc
e		1/4"x20x2"	4 pcs
f		1/4"x12x1(T)	4 pcs
g		1/4"x19x2(T)	4 pcs
h		#8x5/8"	16 pcs
i			4 pcs

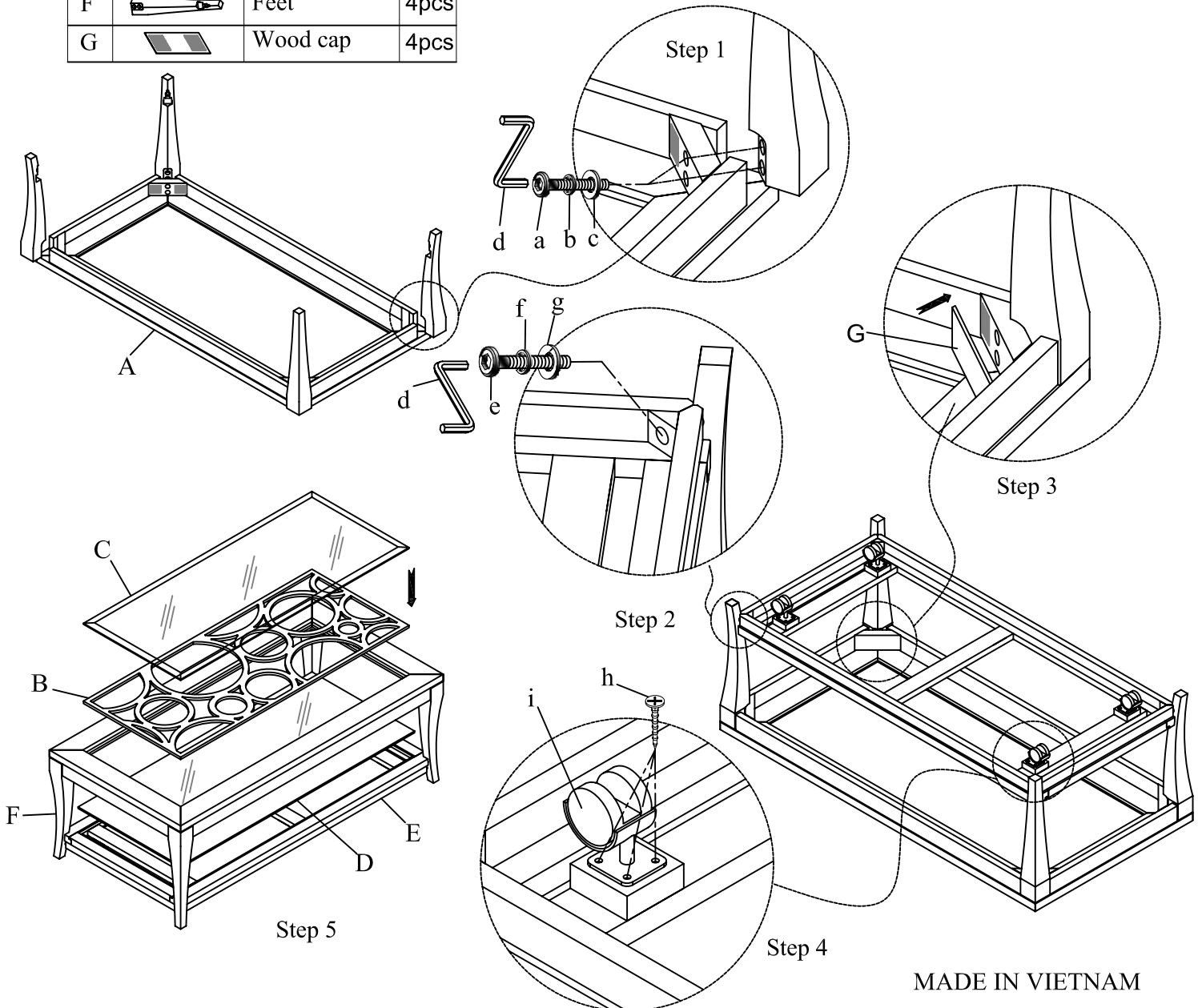
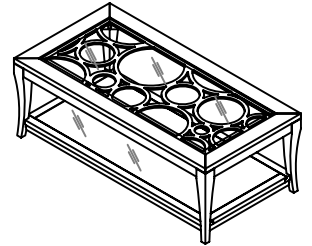















MADE IN VIETNAM

841T-2 End Table Assembly Instructions

Thank you for purchasing this quality product. Be sure to check all packing materials carefully for small parts which may have come loose inside the carton during shipment. Identify and count all parts and compare with the parts list below.

** Assemble the product on a flat, soft surface such as a carpet or cloth to prevent scratching the finish. Read all instruction and study the drawings carefully before starting the assembly process.

NO.	SKETCH	DESCRIPTION	Q'TY
A		Top frame	1 pc
B		Plaque	1 pc
C		Glass	1 pc
D		Mirror	1 pc
E		Lower frame	1 pc
F		Feet	4 pcs
G		Wood cap	4 pcs

NO.	SKETCH	HARDWARE	Q'TY
a		5/16"x18x2"	8 pcs
b		5/16"x12x1(T)	8 pcs
c		5/16"x19x2(T)	8 pcs
d		4mm	1 pc
e		1/4"x20x2"	4 pcs
f		1/4"x12x1(T)	4 pcs
g		1/4"x19x2(T)	4 pcs

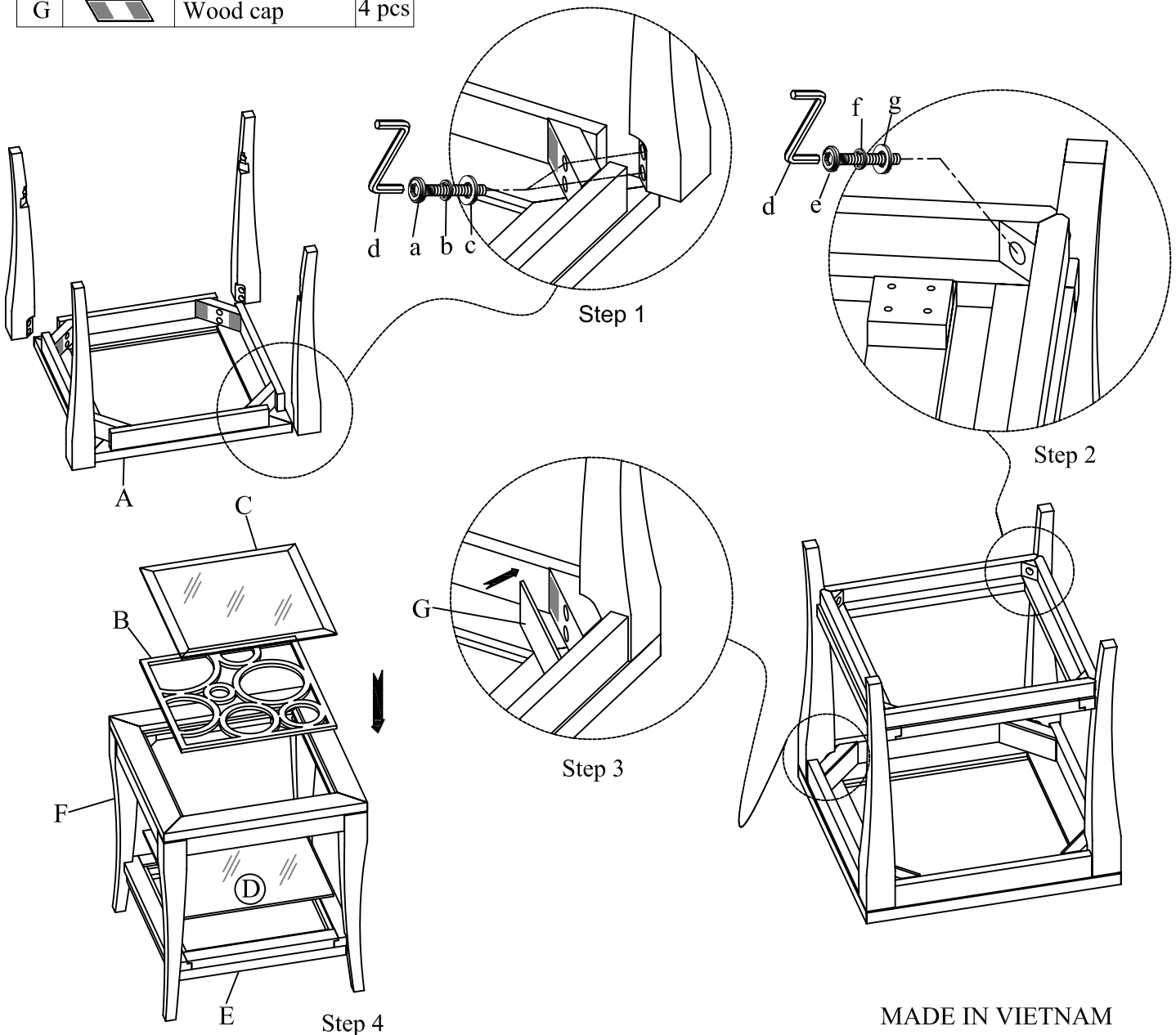







MADE IN VIETNAM







841T-3 Sofa Table

Assembly Instructions

Thank you for purchasing this quality product. Be sure to check all packing materials carefully for small parts which may have come loose inside the carton during shipment. Identify and count all parts and compare with the parts list below.

** Assemble the product on a flat, soft surface such as a carpet or cloth to prevent scratching the finish. Read all instruction and study the drawings carefully before starting the assembly process.

NO.	SKETCH	DESCRIPTION	Q'TY
A		Top frame	1pc
B		Plaque	1pc
C		Glass	1pc
D		Mirror	1pc
E		Lower frame	1pc
F		Feet	4pcs
G		Wood cap	4pcs

NO.	SKETCH	HARDWARE	Q'TY
a		5/16"x18x2"	8 pcs
b		5/16"x12x1(T)	8 pcs
c		5/16"x19x2(T)	8 pcs
d		4mm	1 pc
e		1/4"x20x2"	4 pcs
f		1/4"x12x1(T)	4 pcs
g		1/4"x19x2(T)	4 pcs

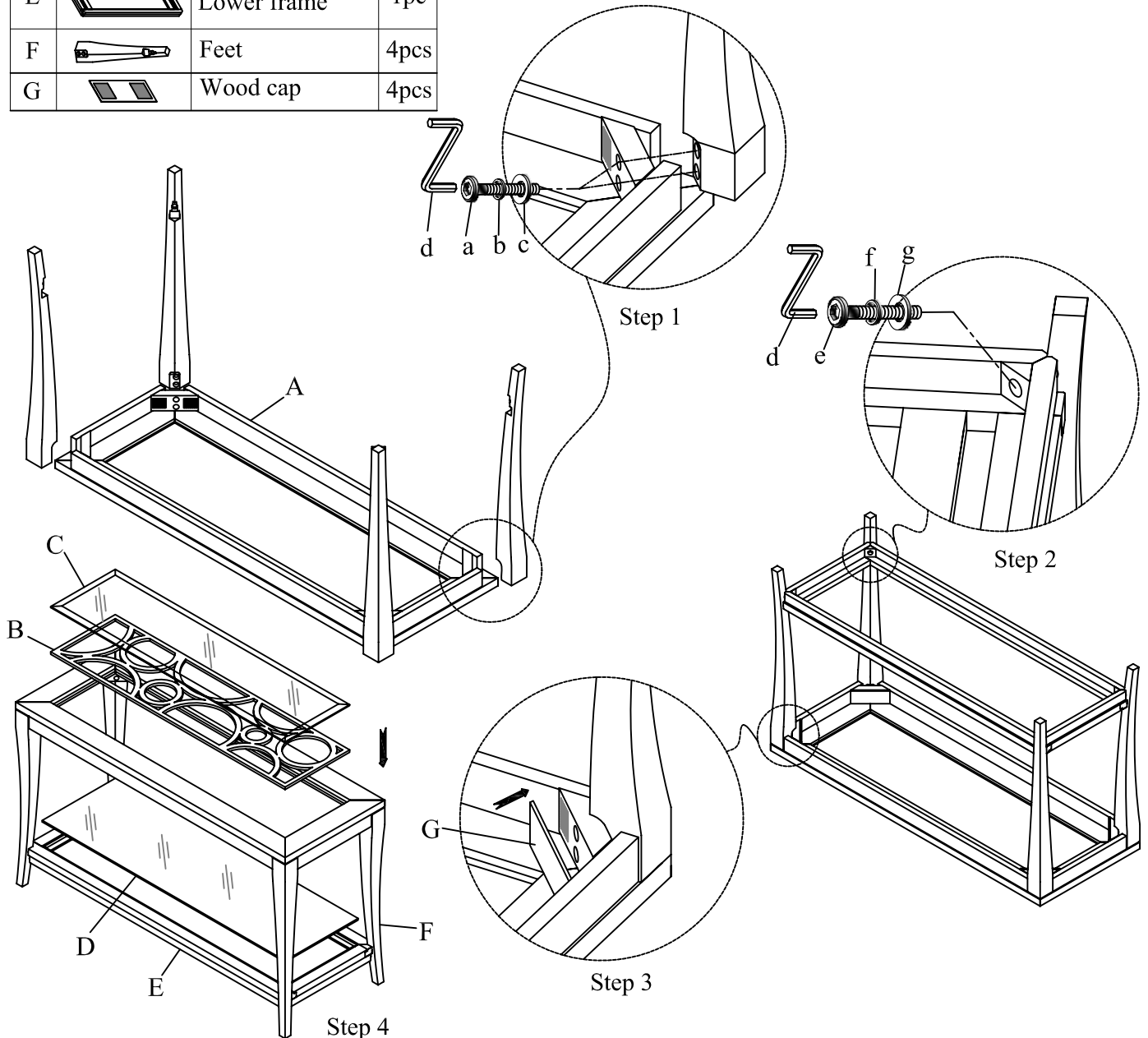
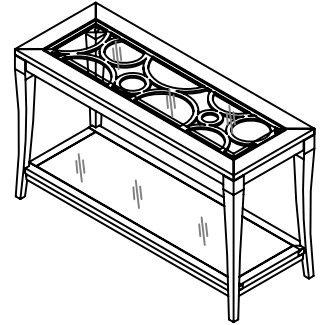

MADE IN VIETNAM