







Assembly Instructions

ITEM NO: 48110/40303

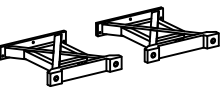
Thank you for purchasing this quality product. Be sure to check all packing material carefully for small parts that may have come loose inside the carton during shipment. (Note: Loosely thread all screws/bolts first. Once the item is assembled then completely tighten.)

PARTS LIST:				HARDWARE LIST:				
No.	Description	Sketch	Quality	No.	Sketch	Description	Size	Quality
1	Table Top		1 Pc	A		Allen Head Bolt	Ø8x40mm	8 Pcs
2	Leg Frames		2 Pcs	B		Lock Washer	Ø9xØ13mm	8 Pcs
				C		Flat Washer	Ø8xØ20mm	8 Pcs
3	Top Stretcher		1 Pc	D		Allen Key	4x110mm	1 Pc

STEP 1

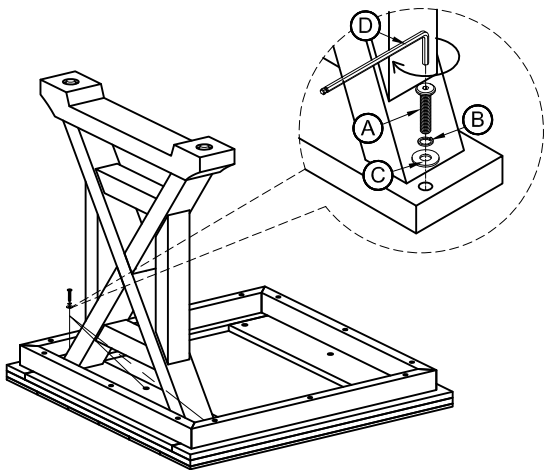

Do not fully tighten the bolts until the complete table has been assembled. Once the complete table is assembled, use the provided Allen Key to fully tighten all the bolts.

STEP 2

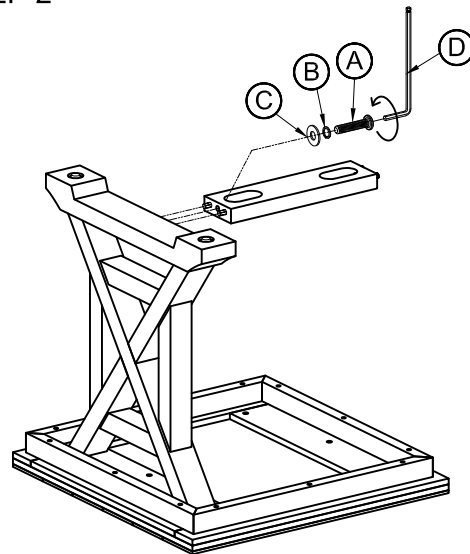

STEP 3

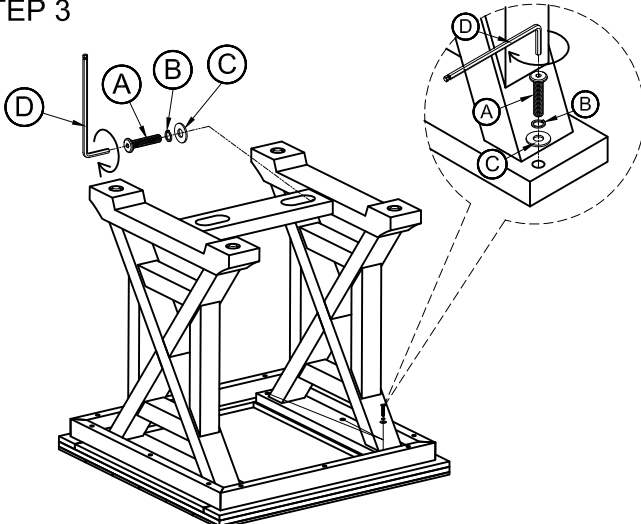

STEP 4

