

Assembly | Asamblea | Assemblage

PO#

Customer service | Servicio al cliente | Service clientèle: 800.633.5096

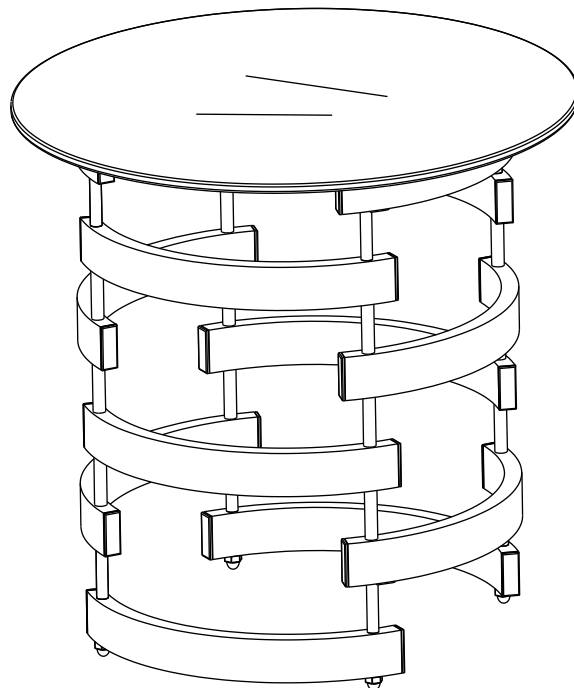

Product number | Número de producto | Numéro de produit

CK5432

Thank you for your purchase! | ¡Gracias por tu compra! | Merci pour votre achat!

Assembly | Asamblea | Assemblage

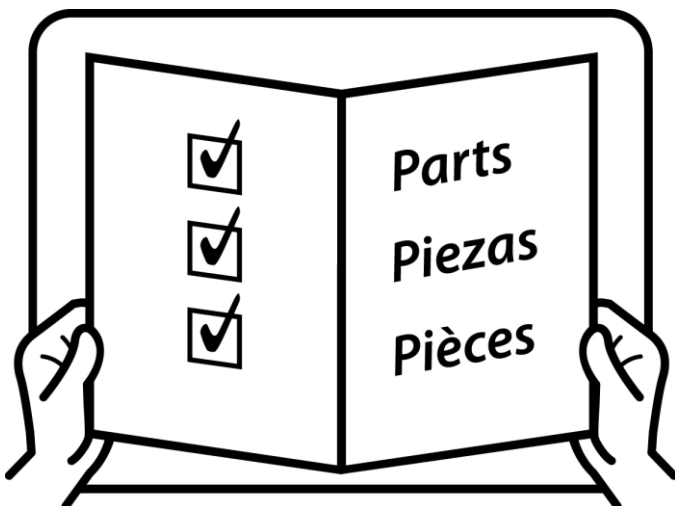
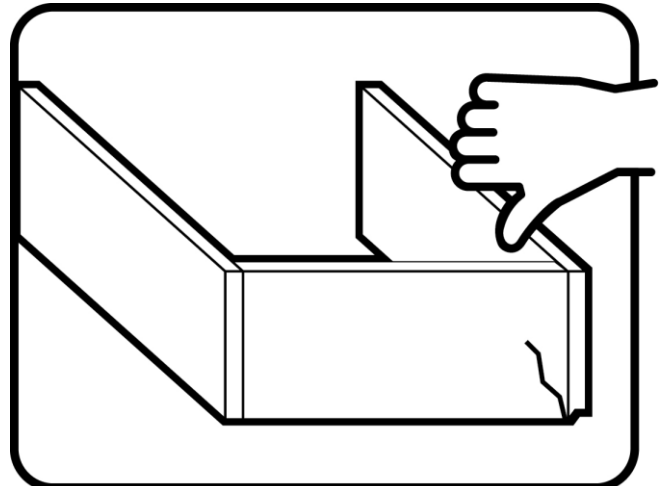
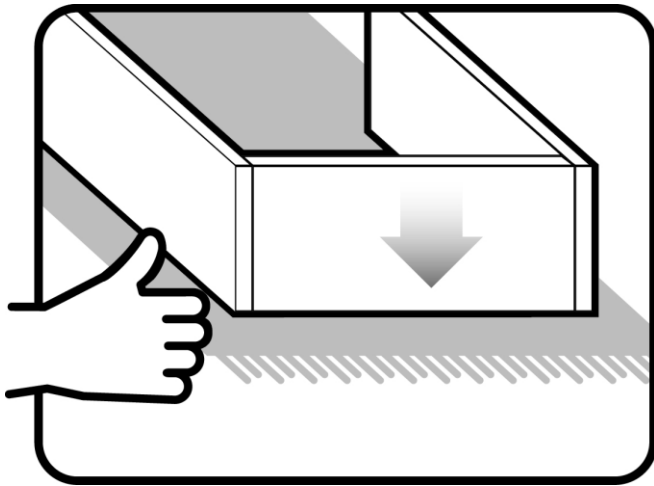
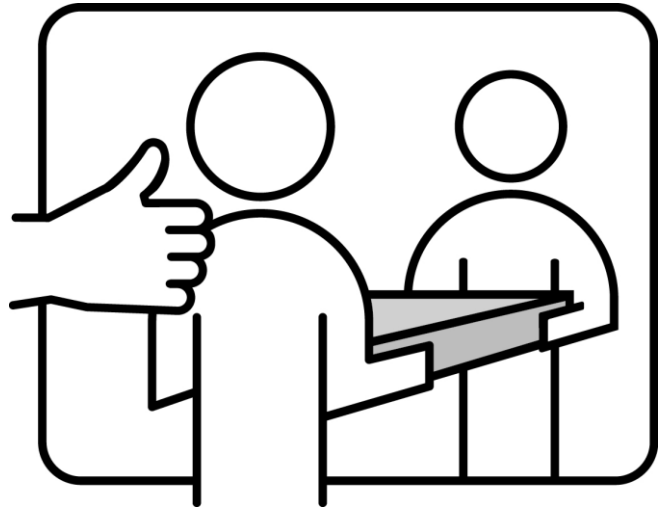
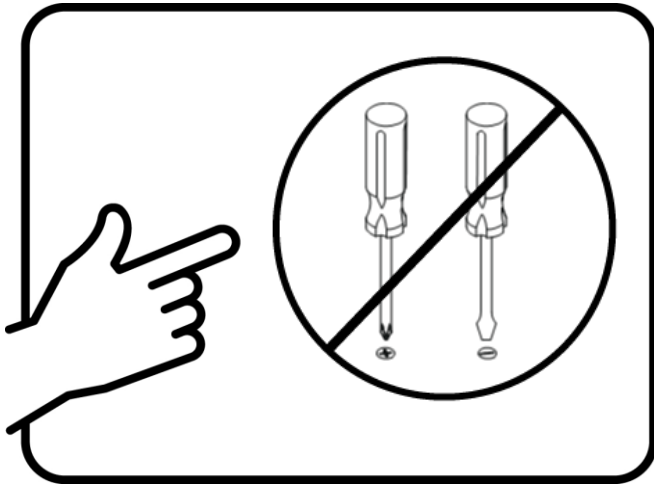

Assembly | Asamblea | Assemblage

Techniques | Técnicas | Techniques



Care | Cuidado | Entretien





Safety | Seguridad | Sécurité



Note! | ¡Nota! | Remarque!

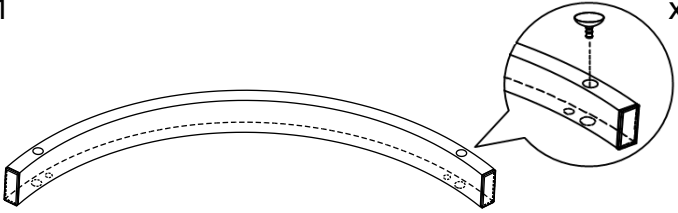
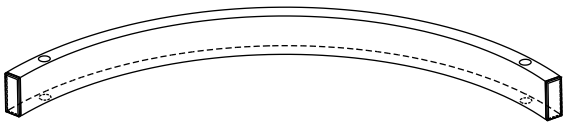
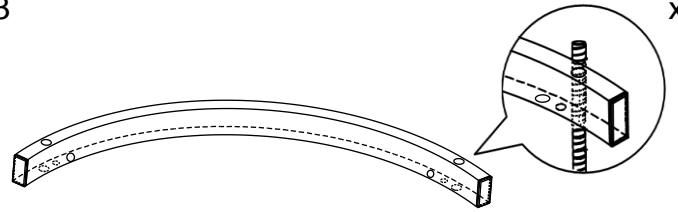
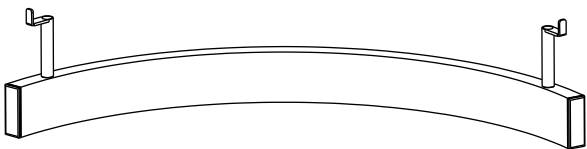
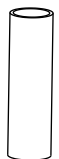
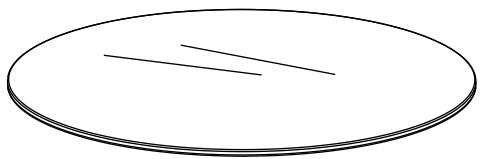
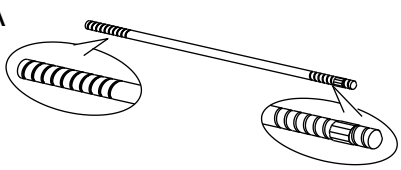

Assembly | Asamblea | Assemblage

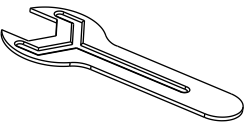
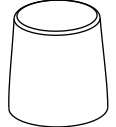
<p>1 x2</p>  <p>Stretcher Camilla Tendeur</p>	<p>2 x4</p>  <p>Stretcher Camilla Tendeur</p>	
<p>3 x2</p>  <p>Stretcher Camilla Tendeur</p>	<p>4 x4</p>  <p>Stretcher Camilla Tendeur</p>	
<p>5 x12</p>  <p>Connector Tube Tubo conector Tube de raccordement</p>	<p>6 x1</p>  <p>Glass Top Tapa de cristal Plateau en verre</p>	
<p>A x4</p>  <p>Long Bolt w/ Stopper Perno largo con tope Longue culasse bouchon 493mm</p>	<p>B x4</p>  <p>Nut Nuez Écrou</p>	<p>C x4</p>  <p>Glass Pad Almohadilla de vidrio Patin de verre</p>
<p>D x1</p>  <p>Open Wrench Llave abierta Clé ouverte</p>	<p>E x4</p>  <p>Plastic Cap Tapa de plástico Casquette en plastique</p>	

Assembly | Asamblea | Assemblage

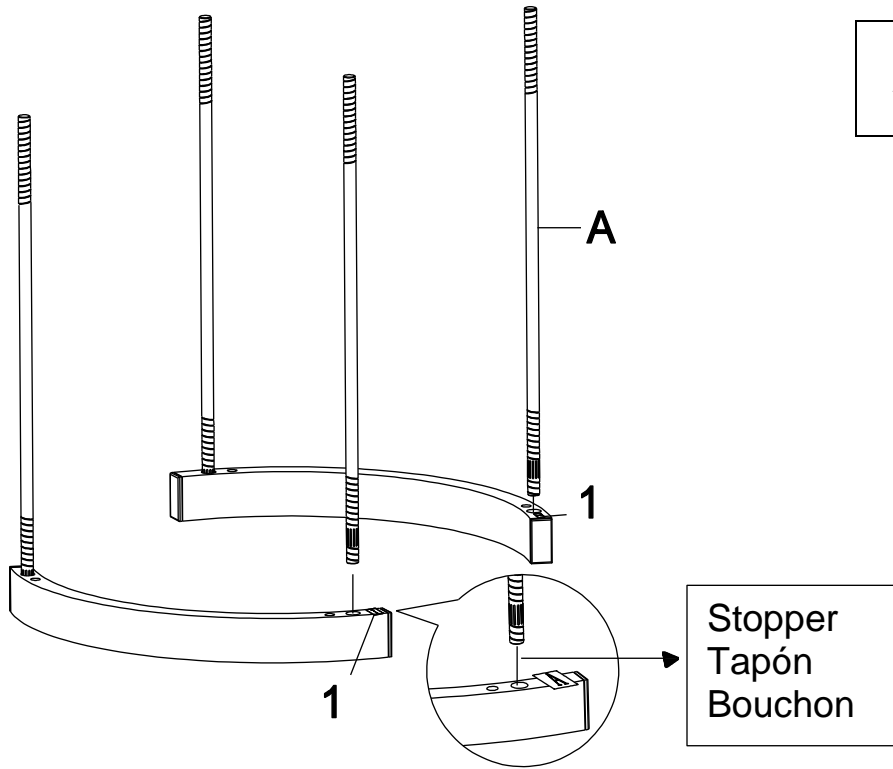

1

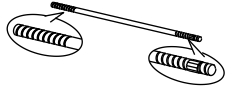

A		X4
---	---	----

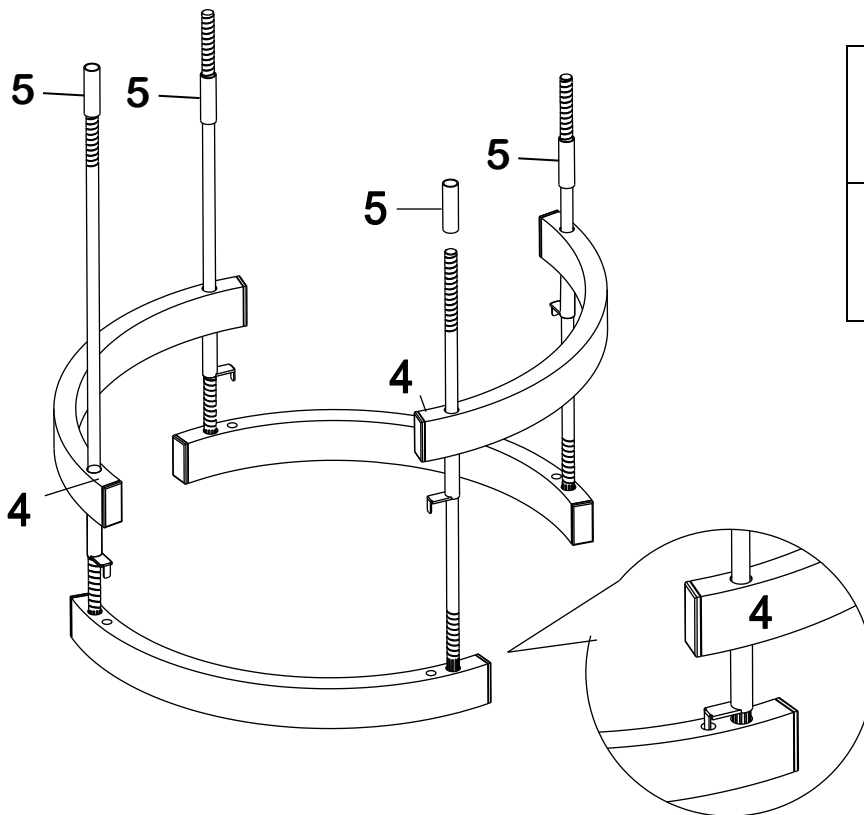
2





5		X4
4		X2

Assembly | Asambla | Assemblage

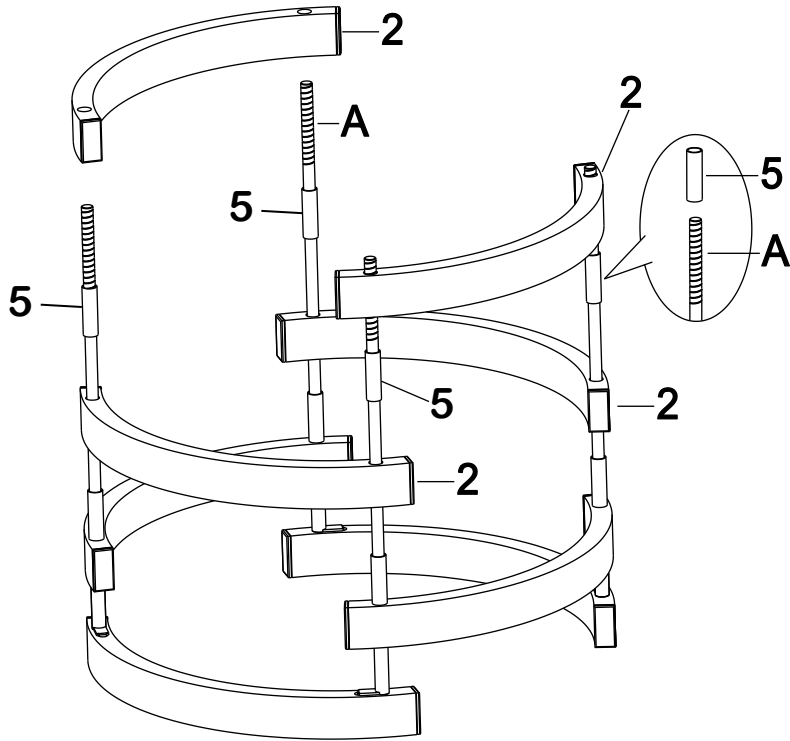
3



5		X4
2		X4

4

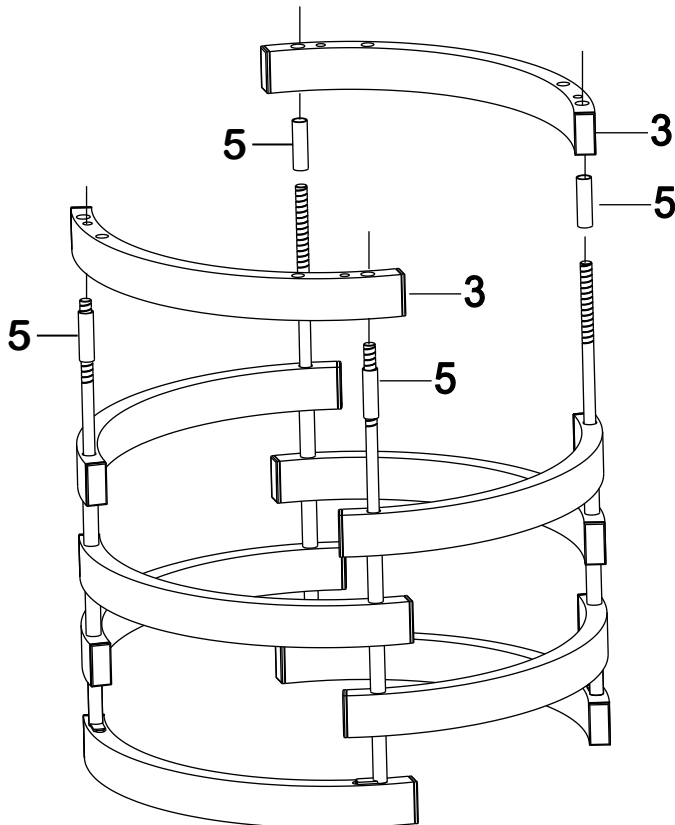

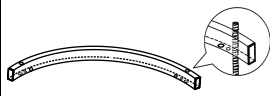
5		X4
3		X2

Assembly | Asambla | Assemblage

5

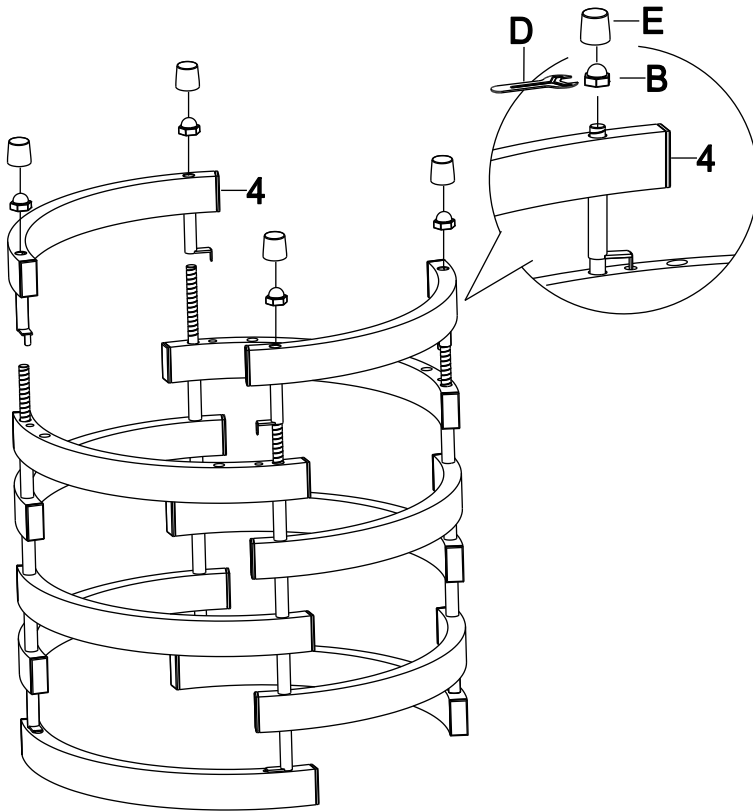

B		X4
D		X1
E		X4

6

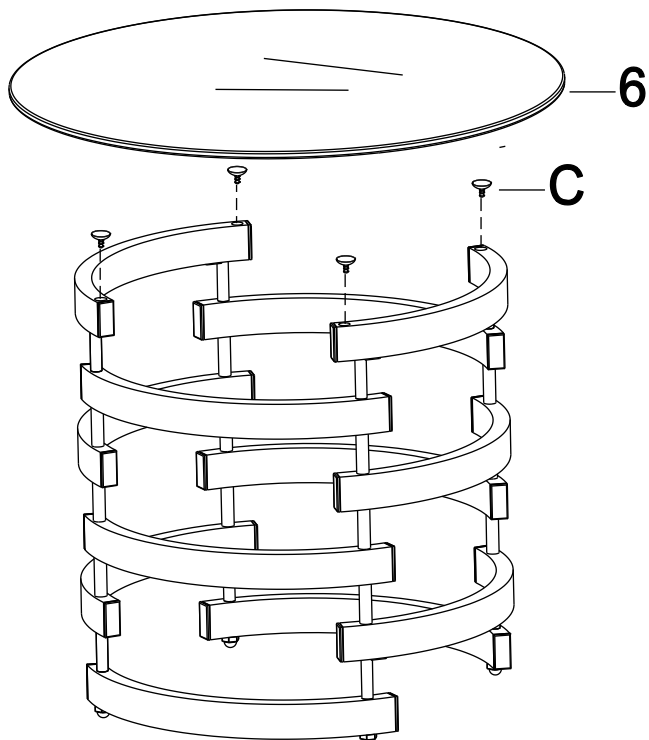

C		X4
---	--	----

Assembly | Asamblea | Assemblage

May We Help You?
800.633.5096

Please have this information ready when you call:

- Item Number
- PO #
- Purchaser Name
- Place of Purchase
- Purchase Date
- Date Product Arrived

Please immediately examine this product carefully. Any request for missing or damaged parts replacement must be received 90 days following the date you received the product. Requests for replacement parts, if available, will be honored within this time frame. Parts will not be available for items that were received fully assembled. We do not recommend modifying products and we are not responsible for any damages due to product modifications. If damages or missing parts are not reported within 90 days of the date you received the product, we are under no obligation to provide parts or replacement merchandise. For product issues, please contact customer service at 800-633-5096 (toll-free) Mon-Fri 8:30am – 4pm CST. For assembly issues, please contact customer service and ask for technical assistance. Regarding product returns, please contact the retailer from whom you purchased the product.

Please note, for items purchased in a retail store, you will need to contact the retailer for all part needs.

Product purchased at garage sales or discount stores is sold as-is and is not covered by the above policy.

¿Podemos ayudarle?
800.633.5096

Tenga a mano esta información cuando llame:

- Número de artículo
- PO #
- Nombre del comprador
- Lugar de compra
- Fecha de compra
- Fecha en que llegó el producto

Por favor, examine este producto detenidamente. Cualquier solicitud de reemplazo de piezas faltantes o dañadas debe recibirse 90 días después de la fecha en que recibió el producto. Las solicitudes de piezas de repuesto, si están disponibles, se cumplirán dentro de este marco de tiempo. Las piezas no estarán disponibles para los artículos que se recibieron completamente ensamblados. No recomendamos modificar los productos y no nos hacemos responsables de los daños debidos a modificaciones del producto. Si los daños o las piezas faltantes no se informan dentro de los 90 días a partir de la fecha en que recibió el producto, no estamos obligados a proporcionar piezas o mercancía de reemplazo. Para problemas con el producto, comuníquese con el servicio al cliente al 800-633-5096 (línea gratuita) de lunes a viernes de 8:30 a.m. a 4 p.m. CST. Para problemas de montaje, comuníquese con el servicio al cliente y solicite asistencia técnica. En cuanto a devoluciones de productos, póngase en contacto con el distribuidor al que le compró el producto.

Tenga en cuenta que para los artículos comprados en una tienda minorista, deberá ponerse en contacto con el minorista para todas las necesidades de la pieza.

El producto comprado en las ventas de garaje o tiendas de descuento se vende tal cual y no está cubierto por la política anterior.

Pouvons-nous vous aider?
800.633.5096

Veillez avoir cette information à portée de main lorsque vous appelez:

- Numéro d'article
- PO #
- Nom de l'acheteur
- Lieu d'achat
- Date d'achat
- Date d'arrivée du produit

S'il vous plaît examiner immédiatement ce produit avec soin. Toute demande de remplacement de pièces manquantes ou endommagées doit être reçue dans les 90 jours suivant la date de réception du produit. Les demandes de pièces de rechange, si elles sont disponibles, seront honorées dans ce délai. Les pièces ne seront pas disponibles pour les articles reçus entièrement assemblés. Nous ne recommandons pas de modifier les produits et nous ne sommes pas responsables des dommages causés par les modifications du produit. Si les dommages ou les pièces manquantes ne sont pas signalés dans les 90 jours suivant la date à laquelle vous avez reçu le produit, nous ne sommes pas tenus de fournir des pièces ou des marchandises de remplacement. Pour les problèmes de produits, veuillez contacter le service à la clientèle au 800-633-5096 (sans frais) du lundi au vendredi de 8h30 à 16h00, heure du Pacifique. Pour les problèmes d'assemblage, veuillez contacter le service clientèle et demander une assistance technique. En ce qui concerne les retours de produits, veuillez contacter le revendeur auprès duquel vous avez acheté le produit.

S'il vous plaît noter, pour les articles achetés dans un magasin de détail, vous devrez contacter le détaillant pour tous les besoins en pièces.

Les produits achetés dans les ventes de garage ou dans les magasins discount sont vendus tels quels et ne sont pas couverts par la politique cidessus.