





ASSEMBLY INSTRUCTIONS











NEFS N630-02 END TABLE
23105302

Thank you for purchasing this quality product . Be sure to check all packing materials carefully for small parts ,which may have come loose inside the carton during shipment . Identify and count all parts and compare with the **HARDWARE LIST** below.

Caution : Please read instructions thoroughly before unpacking assembly parts.

- 1.We recommend that you assemble this product with the assistance of the another person; this will make assembly easier, and will help to eliminate damage to the product or injury to persons during assembly.
- 2,Please do not over tighten screws or bolts until the assembly is completed.
- 3,Please put all parts on a non-abrasive floor before assembly, and follow the assembly steps to assemble your newly purchased product correctly and efficiently.

No.	Parts List	QTY
A	 TABLE TOP BOX	1
B	 BOTTOM PANEL	1
C	 LEG	2

No.	Parts List	QTY
STEP 1	 Allen bolt: $\varnothing 5/16'' \times 1 \ 3/4''$	8
	 Spring washer: $\varnothing 5/16'' \times \varnothing 12\text{mm}$	8
	 Flat washer: $\varnothing 5/16'' \times \varnothing 19 \times 1.5\text{mm}$	8
	 Allen wrench: 4mm	1
STEP 2	 Allen bolt: $\varnothing 5/16'' \times 1 \ 3/4''$	2
	 Spring washer: $\varnothing 5/16'' \times \varnothing 12\text{mm}$	2
	 Flat washer: $\varnothing 5/16'' \times \varnothing 19 \times 1.5\text{mm}$	2
STEP 3	 Allen bolt: $\varnothing 5/16'' \times 1 \ 3/4''$	4
	 Spring washer: $\varnothing 5/16'' \times \varnothing 12\text{mm}$	4
	 Flat washer: $\varnothing 5/16'' \times \varnothing 19 \times 1.5\text{mm}$	4

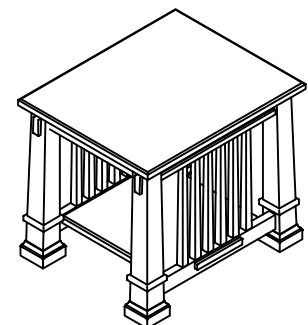
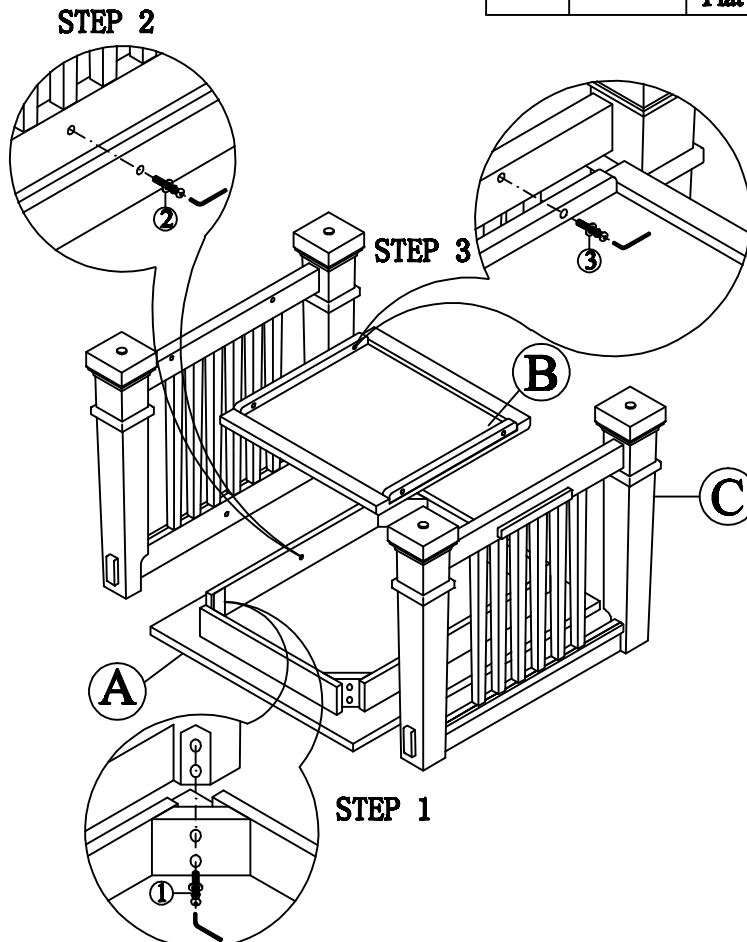

Assembly completed
MADE IN VIETNAM