

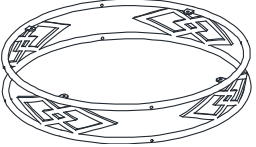

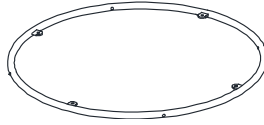
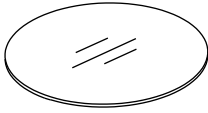
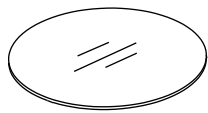
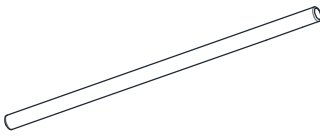

ASSEMBLY INSTRUCTION

E619-04 END TABLE

A Top Frame  1pc	B Bottom Frame  1pc	C Clear Glass  1pc	D Black Glass  1pc
E Metal Bar  4pcs	F End Cap $\Phi 1''$  4pcs	G End Cap $\Phi 1''$  4pcs	H Bolt $1/4'' \times 1''$  12pcs
I Pad $\Phi 12\text{mm}$  8pcs	J Allen Wrench $1/4''$  1pc		

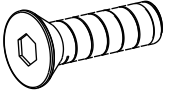
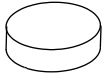

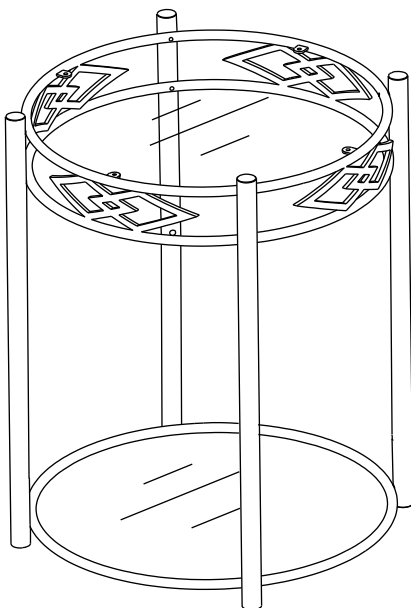
This page lists all the contents included in the box. Please take the time to identify the hardware as well as the individual components to this product. As you unpack and prepare for assembly, place the contents on a carpeted or padded area to protect them from damage.

***** Do not tighten screws & bolts until the entire unit is completely assembled.**

1 Attach Metal Bar (E) to Top Frame (A) and Bottom Frame (B) by Bolt (H) and Allen Wrench (J) as shown.

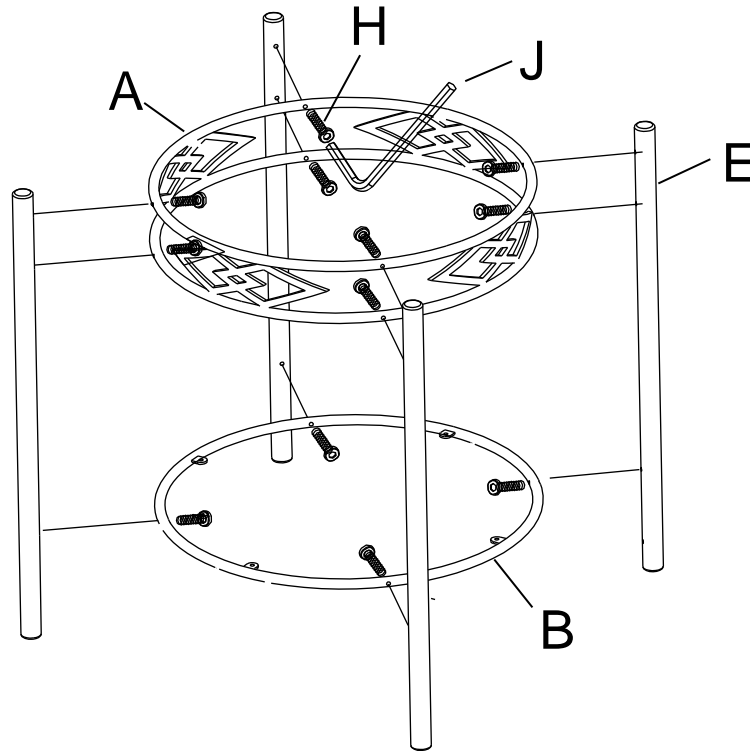

2 Attach End Cap (G) to the top of Metal Bar (E). Attach End Cap (F) to the bottom of Metal Bar (E). Then attach Pad (I) to Top Frame (A) and Bottom Frame (B) as shown.

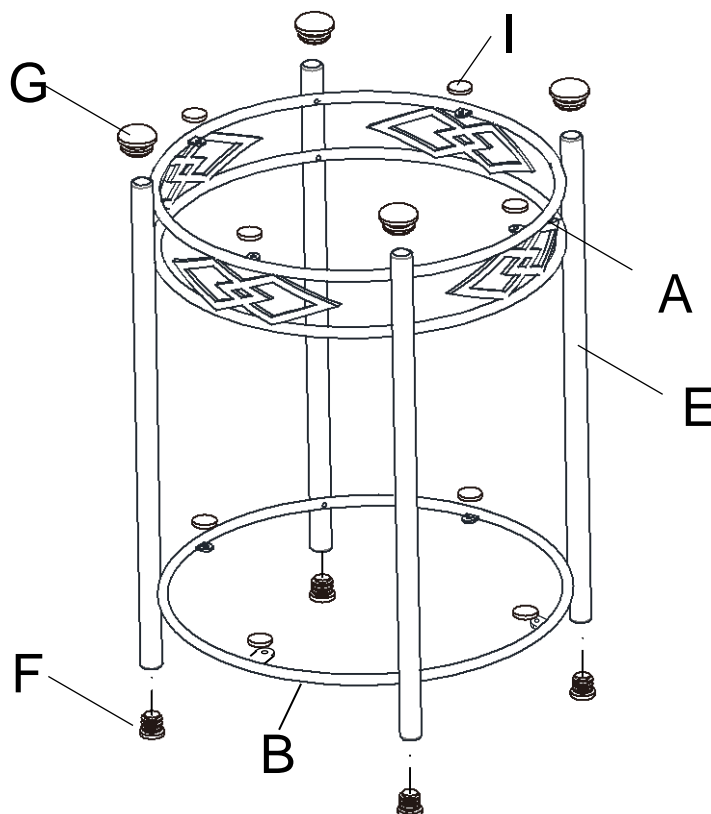

3

Place Clear Glass (C) to the Top Frame (A), and place Black Glass (D) to the Bottom Frame (B) as shown.

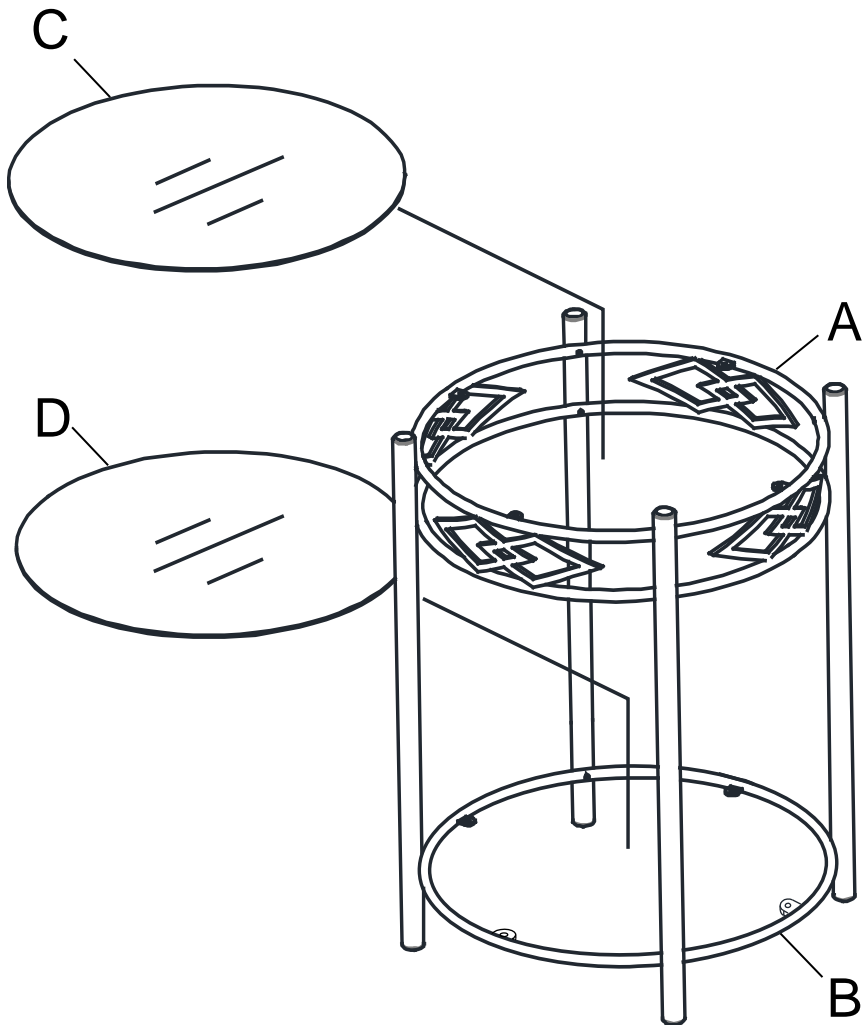

Cleaning & Care

Treat surface with care. Surface is resistant to scratches but is not scratch resistant. Clean surfaces with a dry or damp soft cloth. Do not use abrasive cleaners. Hardware may loosen over time. Periodically check that all connections are tight.