







# Assembly Instructions

DHAR 2677 BLACK/WHITE 4 DOOR CREDENZA SKU# 26026775

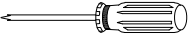
Manufactured by DHAR for Rooms To Go

Version 01 – Date created: 2025/12/17

Step	Code	Hardware List	Q'TY
	a	Allen Key 4x59x20mm 	1Pc
2	b	Bolt(Ø1/4" *20 *15mm)  Pre-installed	10pcs
3	c	Anti-tipping kit 	2 sets
		 Phillip head screwdriver( not included)	

Step	Code	Parts List	Q'TY
1	A	 Cabinet	1pc
2	B	 Legs	2pcs
2	C	 Center leg	1pc

1. We recommend that you should assemble this product with the assistance of another person; this will make assembly easier and will eliminate damage to the product or injury to persons during assembly.
2. Please do not over tighten screws or bolts until assembly is complete.
3. Please put all parts on a non-abrasive floor before assembly, and follow assembly steps to assemble your newly purchased product correctly and efficiently.

## Components

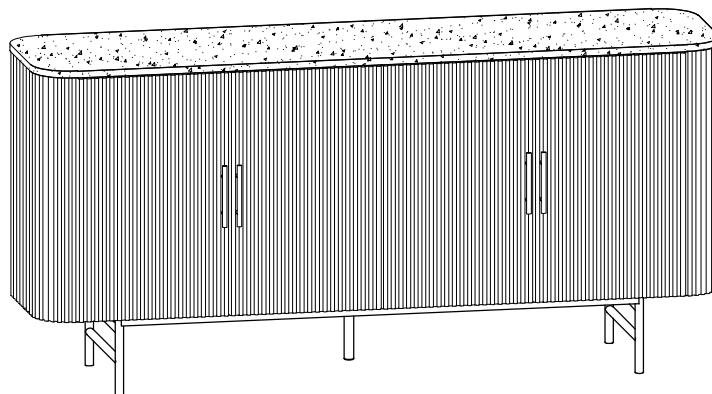

Hardware Pack Location(s): DHAR 2677 BLACK/WHITE 4 DOOR CREDENZA SKU# 26026775

# Assembly Instructions

DHAR 2677 BLACK/WHITE 4 DOOR CREDENZA SKU# 26026775

Version 01 – Date created: 2025/12/17

\*\*\* Caution: Please read all instructions carefully before starting the assembly process. These parts are cumbersome and heavy. Therefore, two people are recommended in order to prevent personal injury and ensure the parts are not damaged during the assembly.

## STEP1:

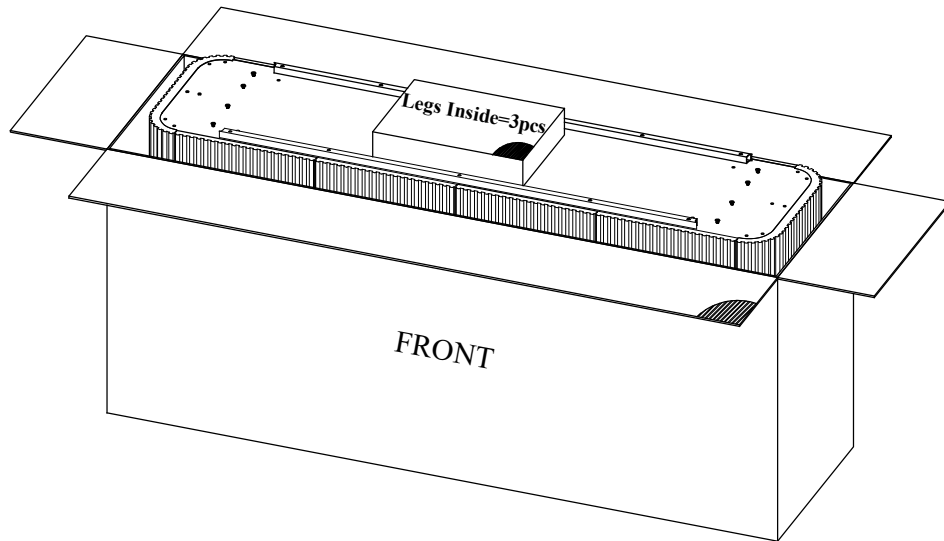

## STEP2:

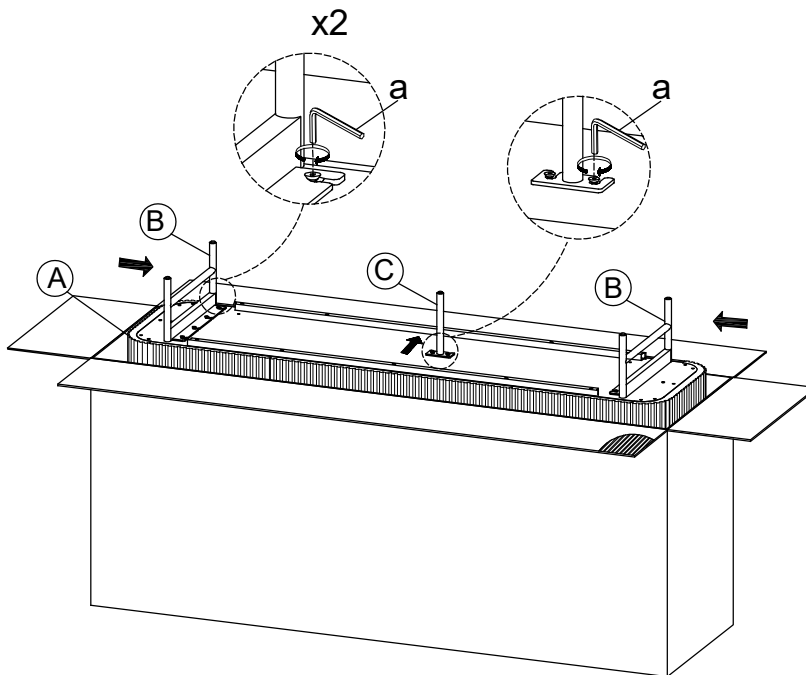

Notes:  
The bolts were pre-assembled on the cabinet bottom

Install the two legs B and the middle leg C onto cabinet A using the pre-installed bolts underneath the bottom of A, then tighten with a hex key.

Hardware Pack Location(s): DHAR 2677 BLACK/WHITE 4 DOOR CREDENZA SKU# 26026775

# Assembly Instructions

DHAR 2677 BLACK/WHITE 4 DOOR CREDENZA SKU# 26026775

Version 01 – Date created: 2025/12/17

## STEP 3:

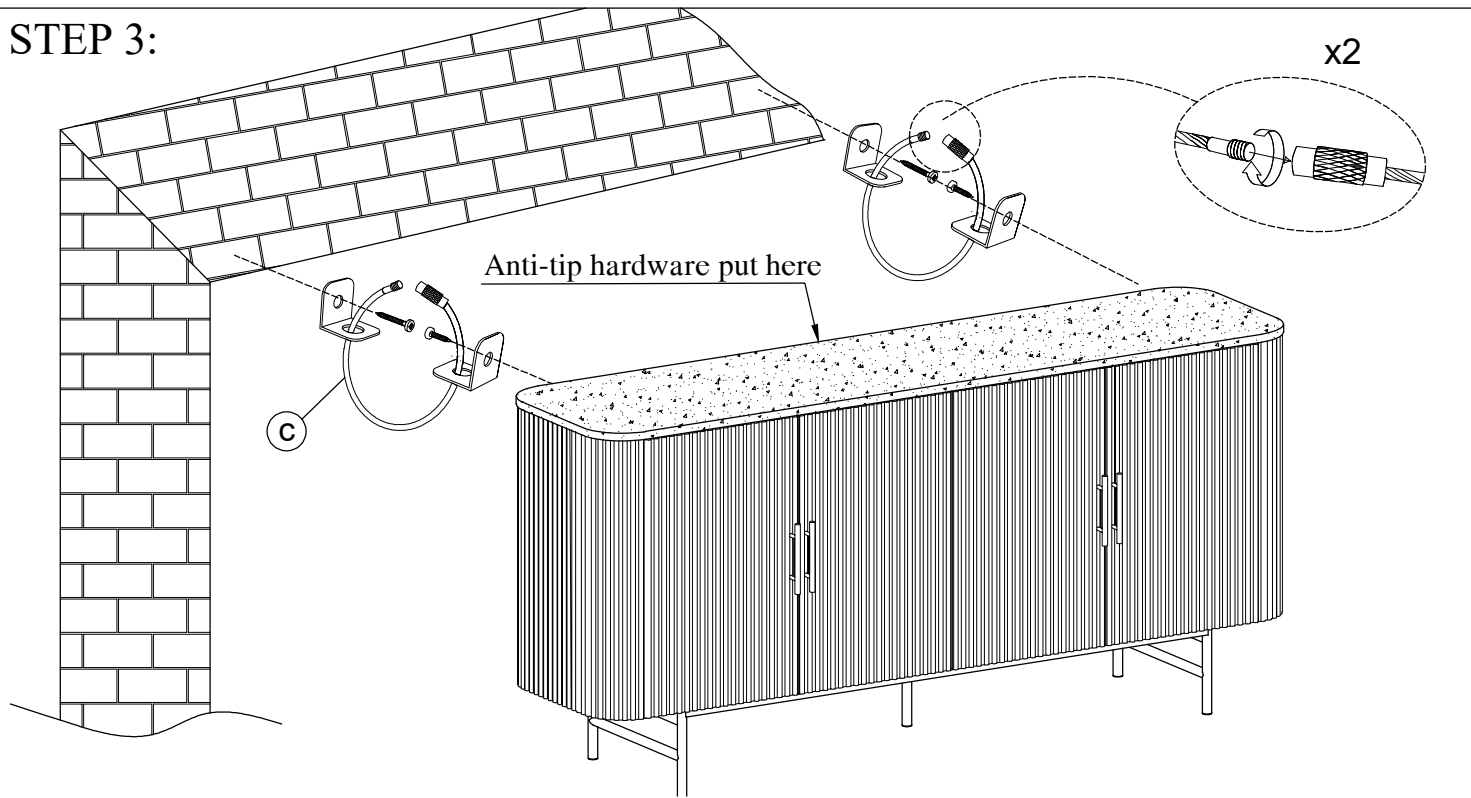

## STEP 4:

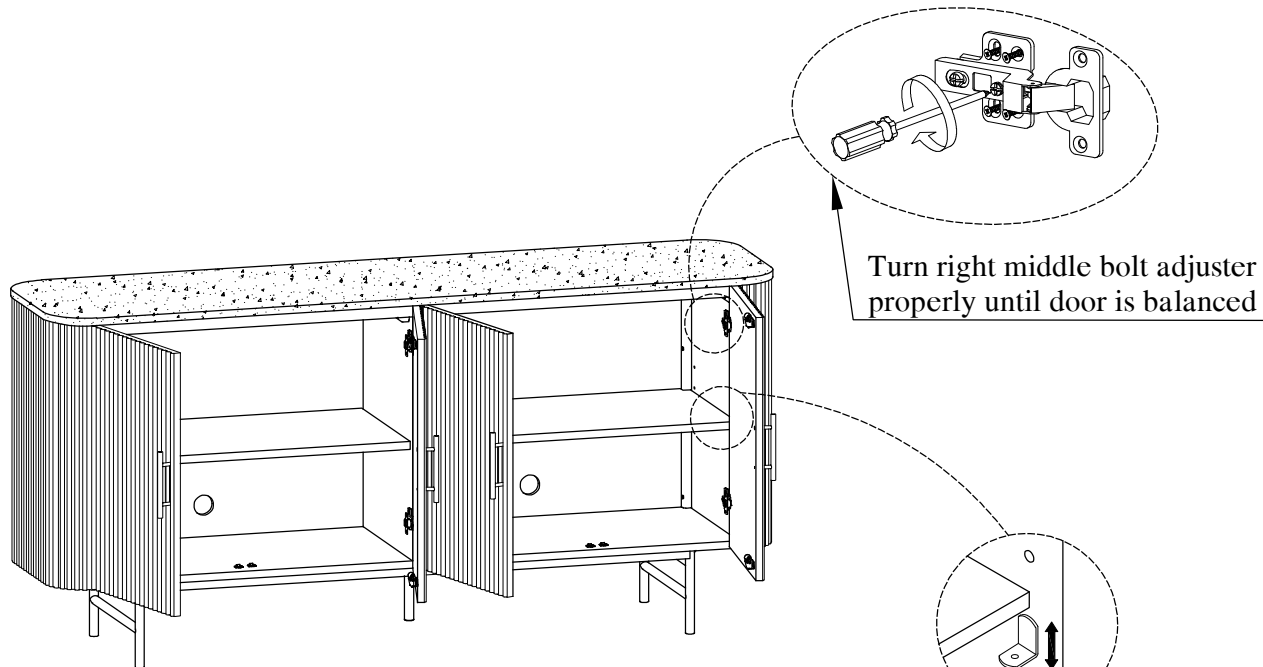

Shelves are secured in place with screws through a metal shelf pin for packing and shipping. In order to adjust the shelf remove the screw with phillips head screwdriver (not included) and reposition to desired height.

Hardware Pack Location(s): DHAR 2677 BLACK/WHITE 4 DOOR CREDENZA SKU# 26026775

# Assembly Instructions

DHAR 2677 BLACK/WHITE 4 DOOR CREDENZA SKU# 26026775

Version 01 – Date created: 2025/12/17

**STEP 5:** DEAR CUSTOMER,  
Caution: Please read all instructions before assembly and check the carton for any parts that may have come loose during shipment. It is recommended to use two or more persons during the assembly process.

\* Press to rotate to the side

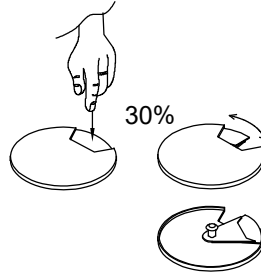

\* Rotate fixed

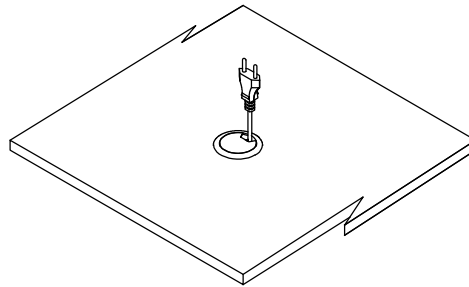

**STEP6:**

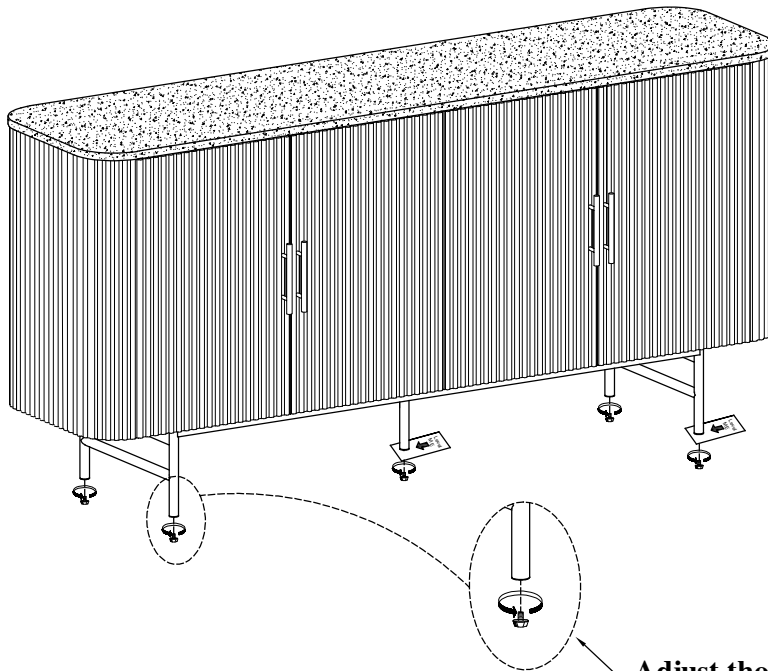

**Adjust the leveler as needed (5 pcs)**

Hardware Pack Location(s): DHAR 2677 BLACK/WHITE 4 DOOR CREDENZA SKU# 26026775