

STEP 2

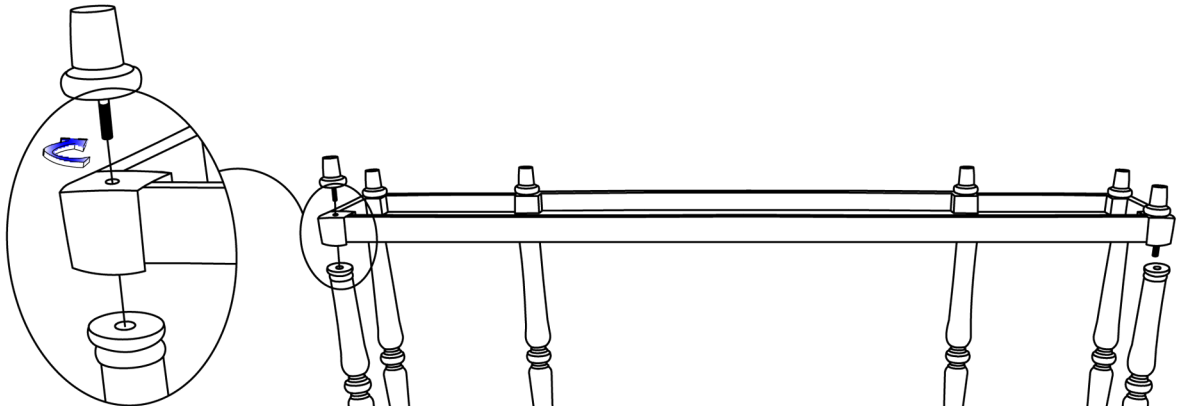

STEP 1

