

# ASSEMBLY INSTRUCTION

## SH2017F-1 FULL SIZE METAL BED

### PART LIST:



A: Finial  
4PCS

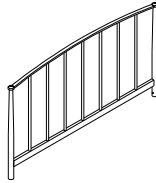

B: Headboard  
1PC

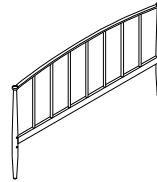

C: Footboard  
1PC

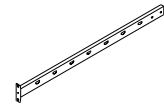

D: Side Rail  
2PCS

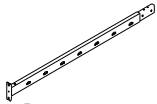

E: Side Rail  
2PCS

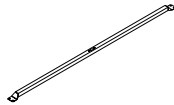

F: Brace  
1PC

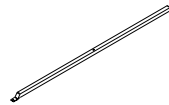

G: Brace  
2PCS

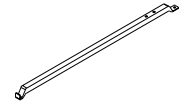

H: Brace  
2PCS



I: Leg  
3PCS



J: Center Support  
Legs  
2PCS

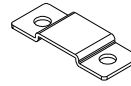

K: Bracket  
1PC

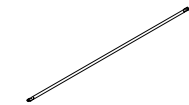

L: Slat  
14PCS



M: Slat Connector  
28PCS



N: Headboard Leg  
1PC



O: Headboard Leg  
1PC

### HARDWARE LIST:



1 : Bolt  
1/4"-20\*22mm  
16PCS



2 : Bolt  
5/16"-20\*19mm  
8PCS



3 : Bolt  
1/4"-20\*17.5mm  
10PCS



4 : Bolt  
1/4"-20\*40mm  
4PCS



5 : 1/4"  
4PCS

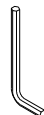

6 : 4mm  
1PC

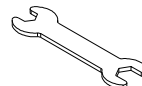

7 : Wrench  
1PC

NOTE: PLEASE DO NOT TIGHTEN ALL BOLTS UNTIL THE BED IS ASSEMBLED COMPLETELY.

### STEP 1:

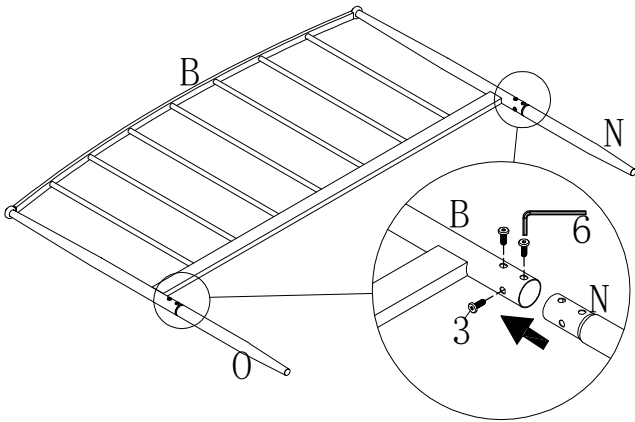

Hardware 3: 6 pcs

### STEP 2:

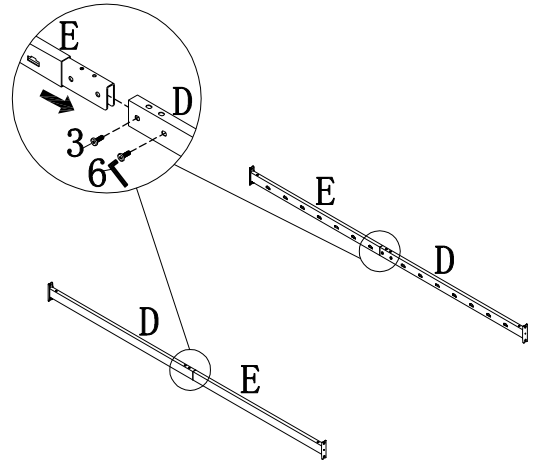

Hardware 3: 4 pcs

### STEP 3:

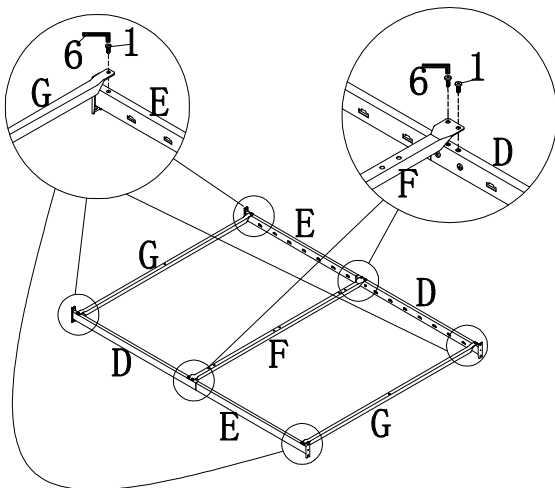

Hardware 1: 8 pcs

### STEP 4:

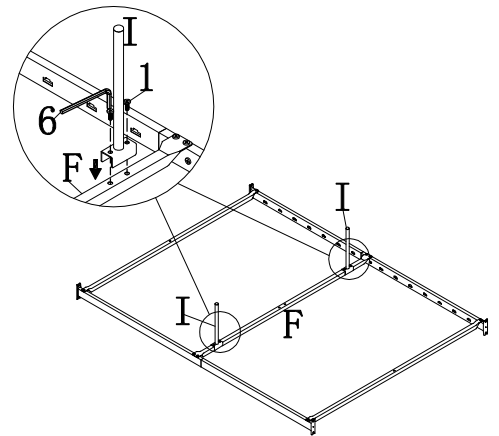

Hardware 1: 4 pcs

### STEP 5:

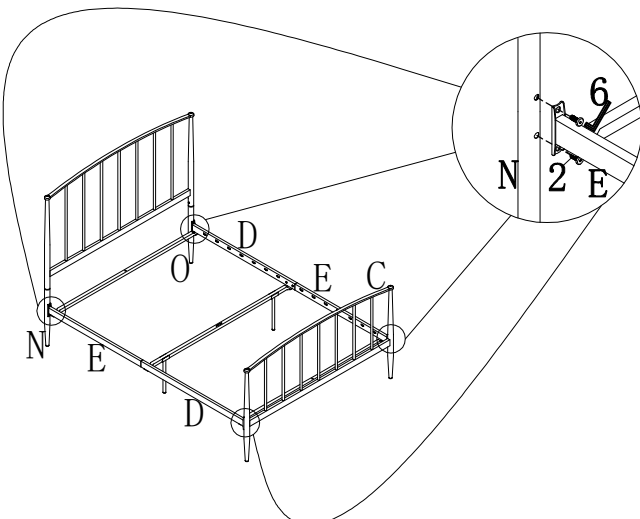

Hardware 2: 8 pcs

### STEP 6:

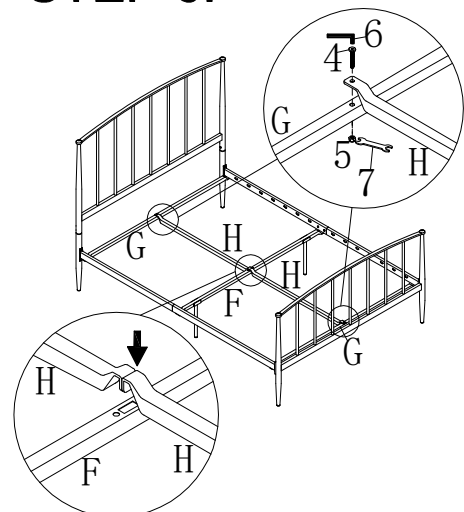

Hardware 4: 2 pcs  
Hardware 5: 2 pcs

NOTE: PLEASE DO NOT TIGHTEN ALL BOLTS UNTIL THE BED IS ASSEMBLED COMPLETELY.

## STEP 7:

Hardware 1: 4 pcs  
Hardware 4: 2 pcs  
Hardware 5: 2 pcs

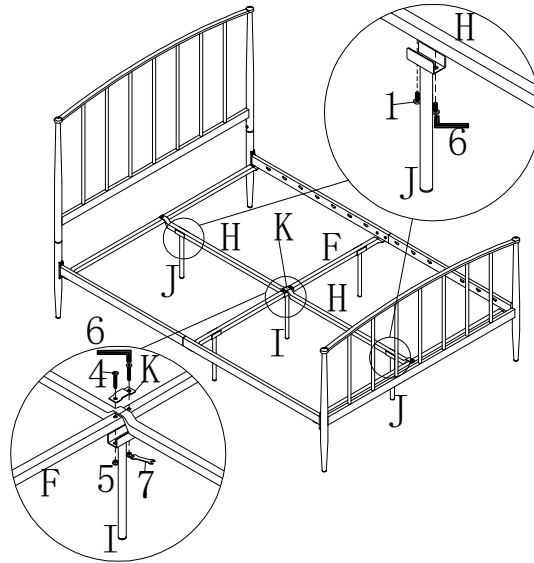

## STEP 8:

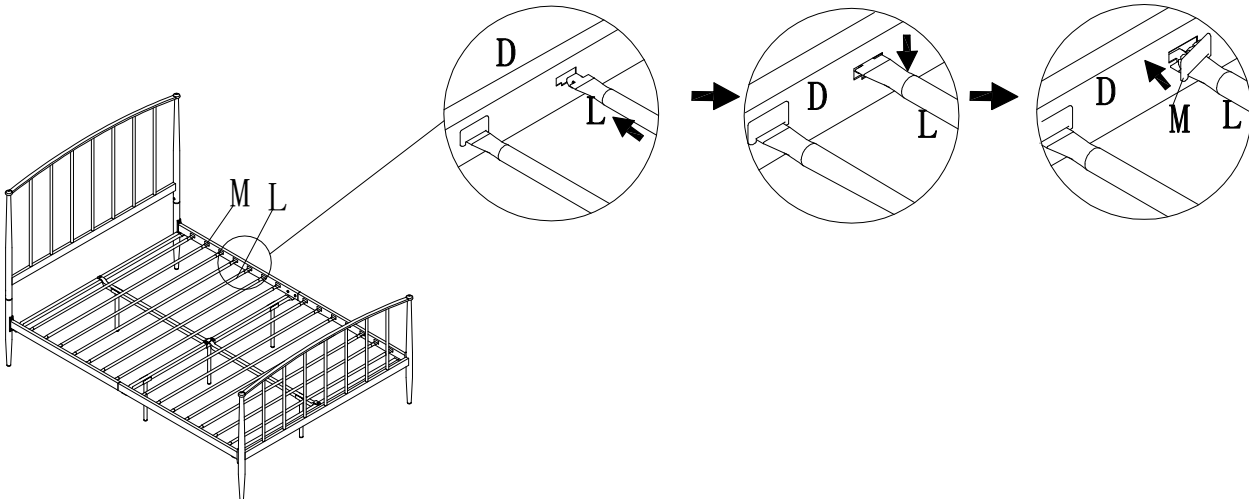

## STEP 9:

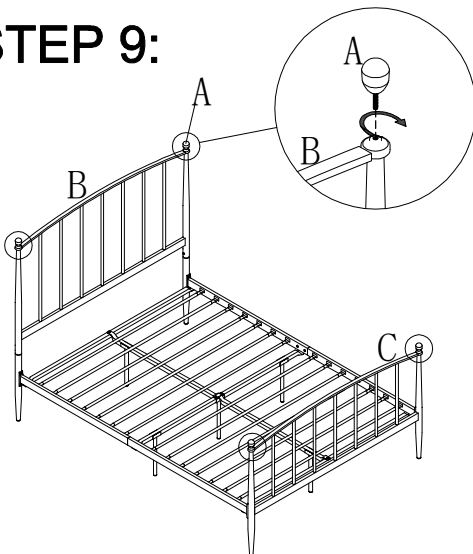

## COMPLETED:

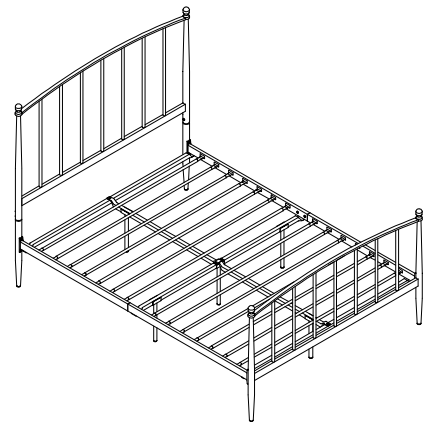

**!** For items use on wooden floor, hard surfaces or carpets, it is recommended to install protective pads under all legs and supports to avoid/prevent from damages/scratches and discoloration.