

PARTS LIST / LISTE DES PIÈCES / LISTA DE PIEZAS

ITEM NO. / ARTICLE NO. / ARTICULO NO :DS-D538-289-1

DESCRIPTION / LA DESCRIPTION / DESCRIPCIÓN : FULL BED / LIT DOUBLE / CAMA DOBLE

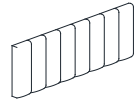
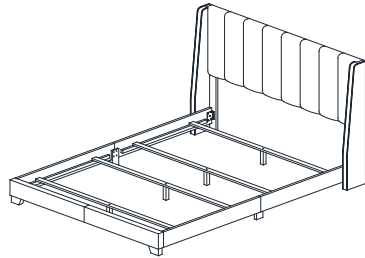

A

x1 Headboard Panel
x1 Tête de lit
x1 Panel de cabecera



B1

x1 Left leg *
x1 Patte de gauche
x1 Pata izquierda

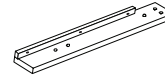

B2

x1 Right Leg *
x1 Patte de droite
x1 Pata derecha

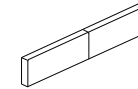

C

x1 Footboard Panel
x1 Pied de lit
x1 Tablero de pie de cama



D

x2 Footboard Leg *
x2 Pattes de pied de lit
x2 Patas del pie de cama

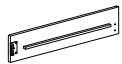

E

x2 Side Rail
x2 Côtés de lit
x2 Largueros laterales

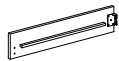

F

x2 Side Rail
x2 Côtés de lit
x2 Largueros laterales



G

x1 Headboard Left Wings
x1 Panneaux latéraux de tête de lit gauche
x1 Laterales de cabecera izquierda



H

x1 Headboard Right Wings
x1 Panneaux latéraux de tête de lit droite
x1 Laterales de cabecera derecha



I

x2 Center Leg *
x2 Pattes centrales
x2 Patas centrales



J

x4 Slat *
x4 Lattes
x4 Listones

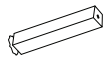

K

x4 Support Leg *
x4 Pied
x4 Pierna de soporte



L

x8 Allen Bolt M8 x 20 *
x8 Vis à tête creuse hexagonale
M8 x 20
x8 Perno Allen M8 x 20



M

x8 Allen Bolt M6 x 25 *
x8 Vis à tête creuse hexagonale
M6 x 25
x8 Perno Allen M6 x 25



N

x16 Allen Bolt M6 x 35 *
x16 Vis à tête creuse hexagonale
M6 x 35
x16 Perno Allen M6 x 35

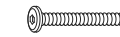

O

x2 Allen Bolt M6 x 70 *
x2 Vis à tête creuse hexagonale
M6 x 70
x2 Perno Allen M6 x 70



P

x2 Wood Dowel *
x2 Goujon en bois
x2 Tarugo de madera



Q

x20 Spring Washer *
x20 Rondelle à ressort
x20 Arandela auto-bloquante



R

x20 Flat Washer *
x20 Rondelle plate
x20 Arandela plana



S

x8 Screw M4 x 32 *
x8 Vis M4 x 32
x8 Tornillo M4 x 32



T

x6 Screw M4 x 38 *
x6 Vis M4 x 38
x6 Tornillo M4 x 38



U

x1 Allen Wrench M5 x 65 *
x1 Clé hexagonale M5 x 65
x1 Llave Allen M5 x 65



V

x1 Allen Wrench M4 x 100 *
x1 Clé hexagonale M4 x 100
x1 Llave Allen M4 x 100

* Replaceable Part



ASSEMBLY INSTRUCTIONS / NOTICE DE MONTAGE / INSTRUCCIONES DE MONTAJE

ITEM NO. / ARTICLE NO. / ARTICULO NO :DS-D538-289-1

DESCRIPTION / LA DESCRIPTION / DESCRIPCIÓN : FULL BED / LIT DOUBLE / CAMA DOBLE

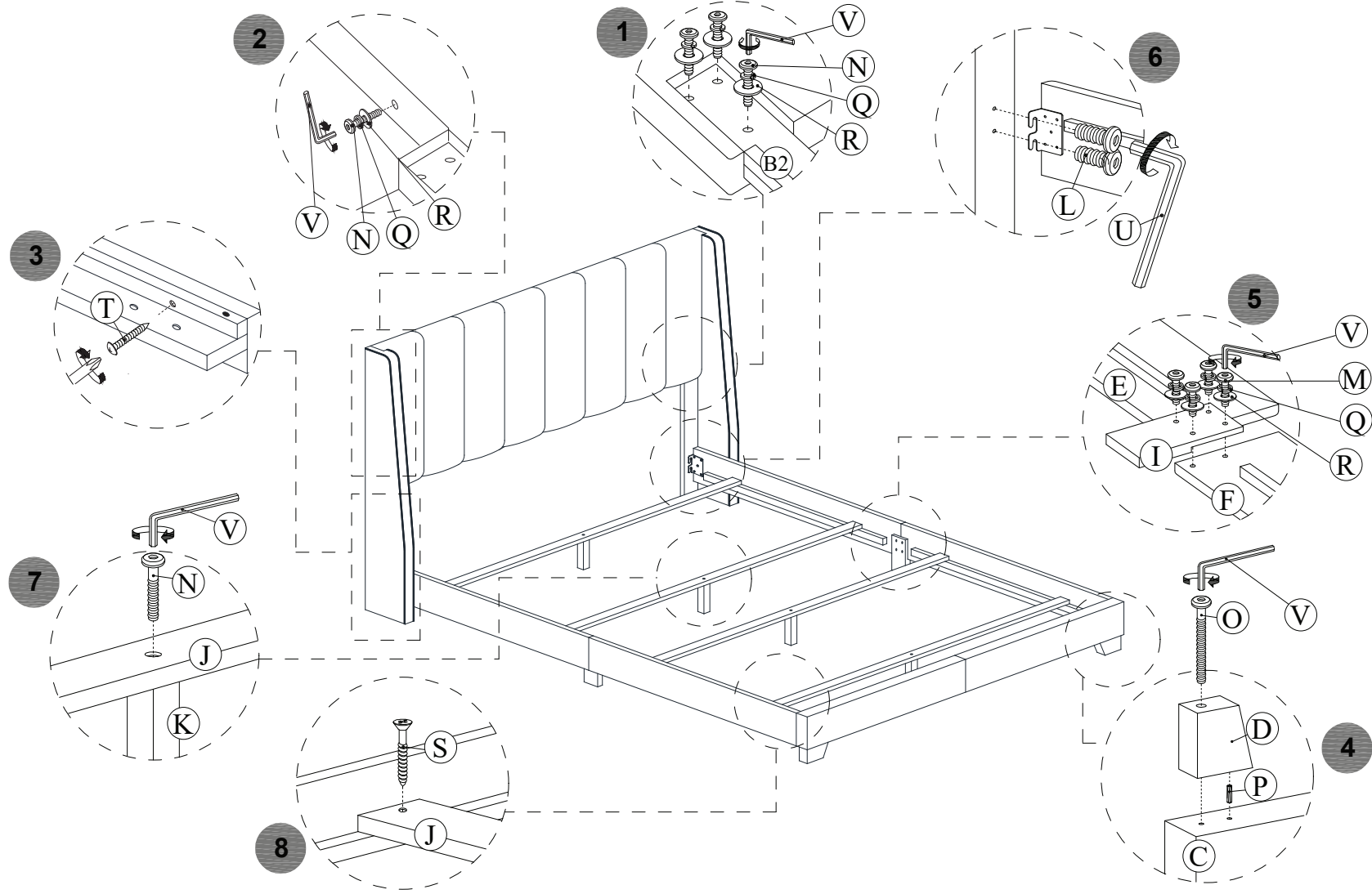



REPLACEABLE PART / PARTIE REMPLACABLE / PARTE REEMPLAZABLE

ITEM NO. / ARTICLE NO. / ARTICULO NO :DS-D538-289-1

DESCRIPTION / LA DESCRIPTION / DESCRIPCIÓN : FULL BED / LIT DOUBLE / CAMA DOBLE

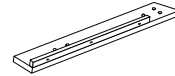

x1 RD538-290-LEGL-Headboard Left Leg *
Patte de gauche
Pata izquierda

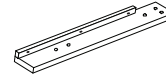

x1 RD538-290-LEGR-Headboard Right Leg *
Patte de droite
Pata derecha



x2 RD538-290-FOOT-Foot *
Pattes de pied de lit
Patas del pie de cama



x2 RD538-290-CELEG-Center Leg *
Pattes centrales
Patas centrales



x4 RD538-289-SLAT-Slat *
Lattes
Listones

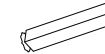

x4 RD538-290-SULEG-Slat Support Leg *
Pied
Pierna de soporte

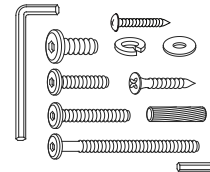
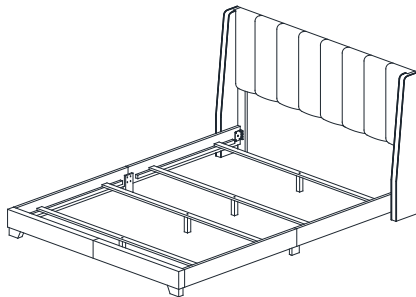

x1 RD538-288-HWKIT-Hardware kit *
Liste des pièces de quincaillerie
Lista del kit de materiales

* Replaceable Part

Protect Your Wood or Laminate Flooring

*This statement applies to any floor without carpet.

If not careful, all furniture including upholstery and case pieces can scratch, scuff and even gouge floors. The recommendation is to have felt, rubber pads or area rugs under furniture on flooring without carpet.

Moving your furniture

Pushing and dragging furniture over floors without carpet can lead to scratches and scuffs. Have someone help when moving the larger pieces of furniture by lifting, try using a dolly or moving pads.

Felt and rubber pads

Applying furniture pads to the feet of furniture helps cushion contact points. Furniture pads can be found at local hardware stores. Felt pads slide easily across the floor, making them ideal for dining chairs and other pieces that move with use. Rubber pads will help furniture stay in place and are perfect for larger pieces, like sofas and loveseats.

Area rugs and rug pads

Using an area rug under furniture is another way to protect your floor from scratches and scuff marks. A rug pad under the area rug will provide extra cushion and added protection.