

ASSEMBLY INSTRUCTIONS  
INSTRUCTIONS D'ASSEMBLAGE  
INSTRUCCIONES PARA EL ENSAMBLAJE

Page 1 of 4  
Page 1 de 4  
Página 1 de 4

**Item/ No d' article/ Artículo:**

**D218-270 6/6 Headboard**

**Tête de très grand lit standard et californien**

**Cabecera de 6/6**

**D218-271 6/6 Footboard & Rails**

**Pied de très grand lit standard avec traverses**

**Pie de cama y travesaños de 6/6**

Thank you for purchasing this quality product. Be sure to check all packing material carefully for small hardware which may have come loose inside the carton during shipment. Identify and count all hardware and compare with the hardware list below.

Merci d'avoir acheté ce produit de qualité. Vérifier de bien avoir toutes les petites pièces de quincaillerie en votre possession; certaines ont pu se retrouver dans le fond de la boîte durant le transport. Identifier et compter les pièces de quincaillerie, puis les comparer avec la liste ci-dessous.

Gracias por su compra de este producto de calidad. Revise con cuidado el cajón donde se encuentra el paquete de materiales. Algunos materiales pequeños podrían haber salido del paquete durante el transporte. Identifique y cuente el material y compárelo con la lista proporcionada abajo.

When placing furniture on non-carpeted flooring, HMI recommends the use of floor protection such as an area rug or furniture pads. Area rugs and padding not included with purchase.

Avant de déposer le meuble sur un revêtement de sol rigide, HMI recommande de protéger le plancher en utilisant une carpeite ou des patins, par exemple. Carpeite et patins non compris.

Antes de colocar el mueble en un suelo sin alfombra, HMI recomienda protegerlo con un tapete o almohadillas, por ejemplo. Tapete y almohadillas no incluidos.

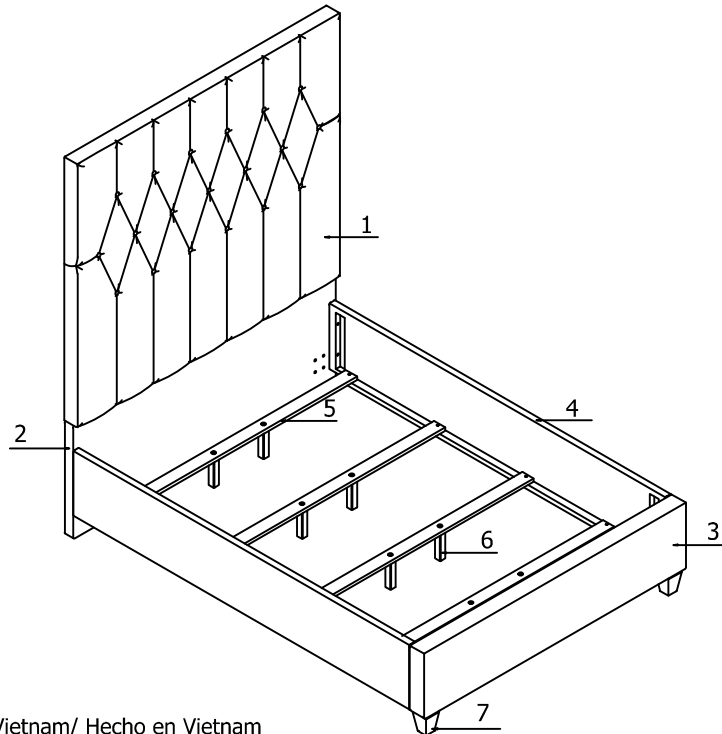

	<b>Parts List/ Liste des pièces/ Lista de piezas</b>	
1	Headboard/ Tête de lit/ Cabecera	<b>1 PC</b>
2	Base/ Base/ Base	<b>1 PC</b>
3	Footboard/ Pied de lit/ Pie de cama	<b>1 PC</b>
4	Side Rail/ Traverse/ Travesaño lateral	<b>2 PCS</b>
5	Slat/ Latte/ Listone	<b>4 PCS</b>
6	Slat Support/ Support de lattes/ Soporte de listones	<b>8 PCS</b>
7	Footboard Leg/ Patte de pied de lit/ Pata del pie de cama	<b>2 PCS</b>

ASSEMBLY INSTRUCTIONS  
 INSTRUCTIONS D'ASSEMBLAGE  
 INSTRUCCIONES PARA EL ENSAMBLAJE

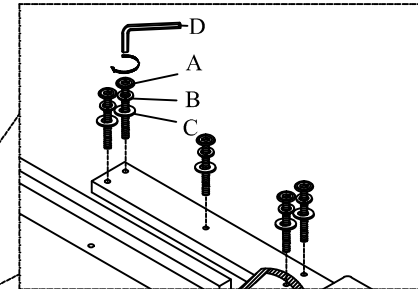
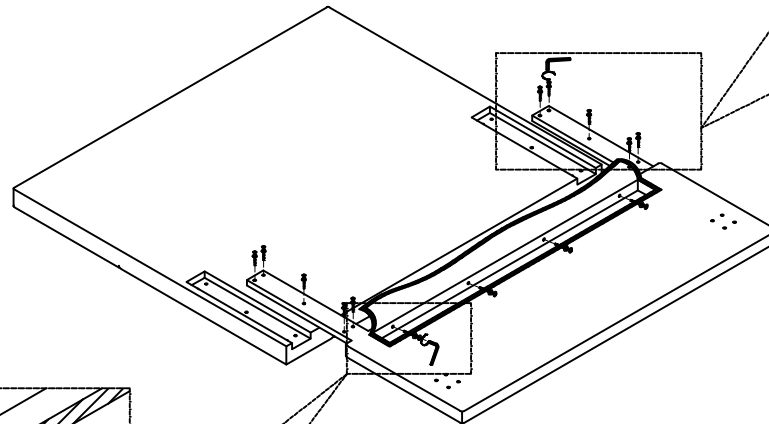
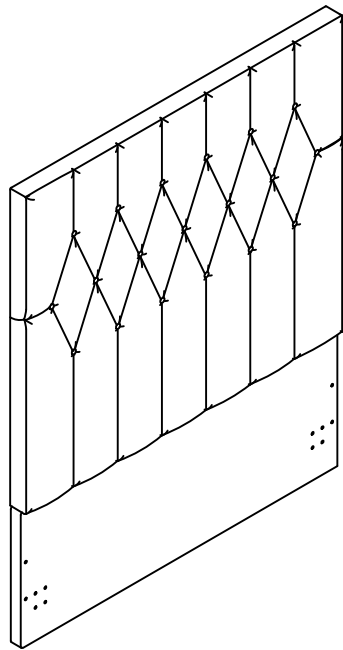



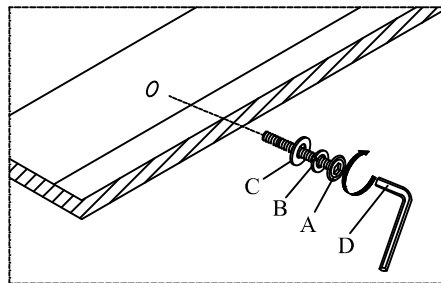

Step 2  
 Étape 2  
 Paso 2





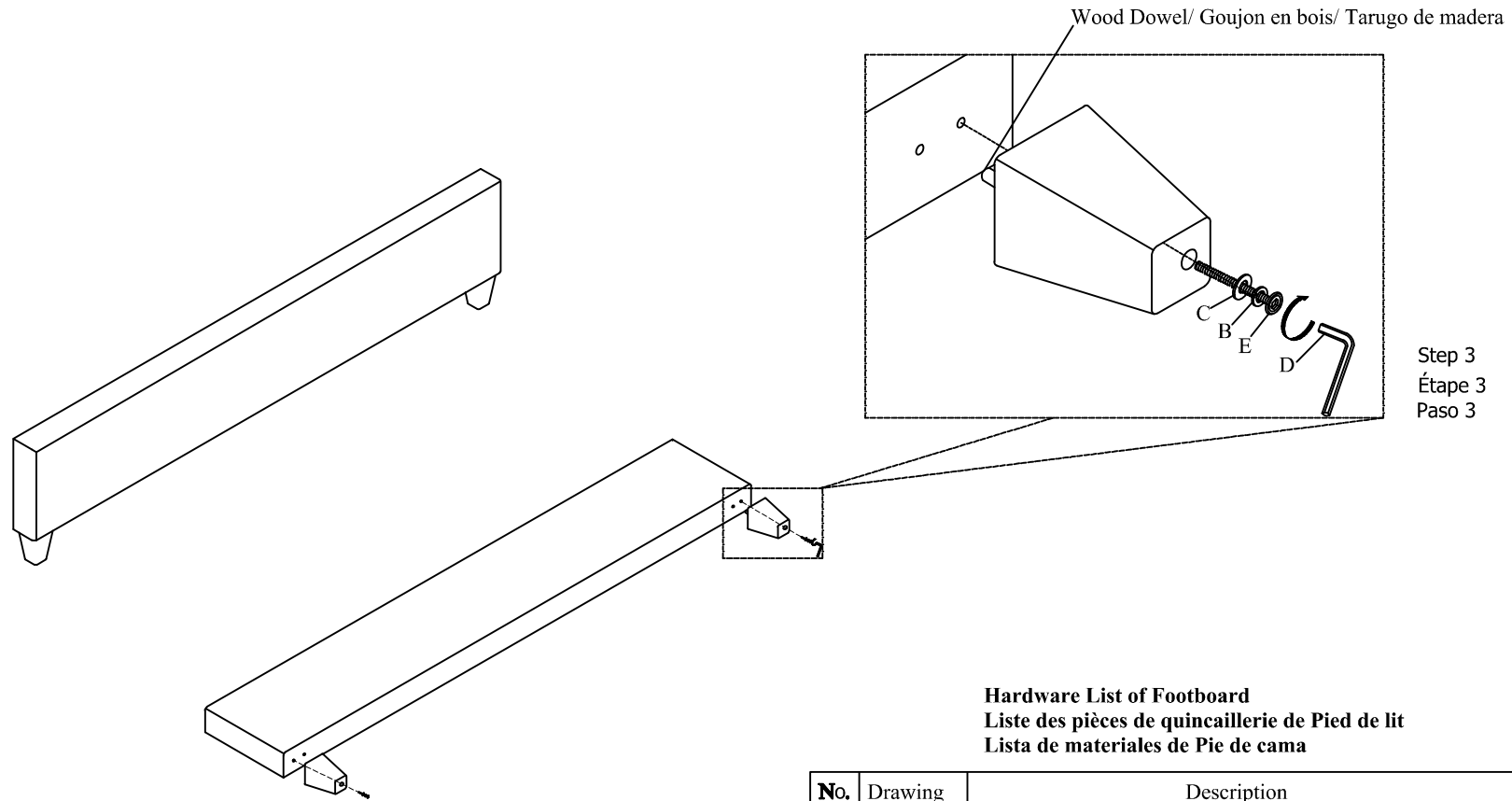

Step 1  
 Étape 1  
 Paso 1

**Hardware list of Headboard**  
**Liste des pièces de quincaillerie de Tête de lit**  
**Lista de materiales de Cabecera**

No.	Drawing No.	Description	Quantity
No.	Illustration	La Description	Quantité
No.	Esquema	Descripción	Cantidad
A		Ø5/16"*1 3/4" Allen Bolt/ Vis à tête creuse hexagonale/Perno Allen	14PCS
B		Ø5/16"*Ø11*1.5 Lock washer/ Rondelle de blocage/ Arandela de seguridad	14PCS
C		Ø5/16"*Ø19*2 Flat washer/ Rondelle plate/ Arandela plana	14PCS
D		4mm Allen Wrench/ Clé hexagonale/ Llave Allen	1PC



**Hardware List of Footboard**  
**Liste des pièces de quincaillerie de Pied de lit**  
**Lista de materiales de Pie de cama**

No.	Drawing No. Illustration No. Esquema	Description La Description Descripción	Quantity Quantité Cantidad
E		Ø5/16"*3 1/2" Allen Bolt/ Vis à tête creuse hexagonale/Perno Allen	2PCS
B		Ø5/16"*Ø11*1.5 Lock washer/ Rondelle de blocage/ Arandela de seguridad	2PCS
C		Ø5/16"*Ø19*2 Flat washer/ Rondelle plate/ Arandela plana	2PCS
D		4mm Allen Wrench/ Clé hexagonale/ Llave Allen	1PC

ASSEMBLY INSTRUCTIONS  
INSTRUCTIONS D'ASSEMBLAGE  
INSTRUCCIONES PARA EL ENSAMBLAJE

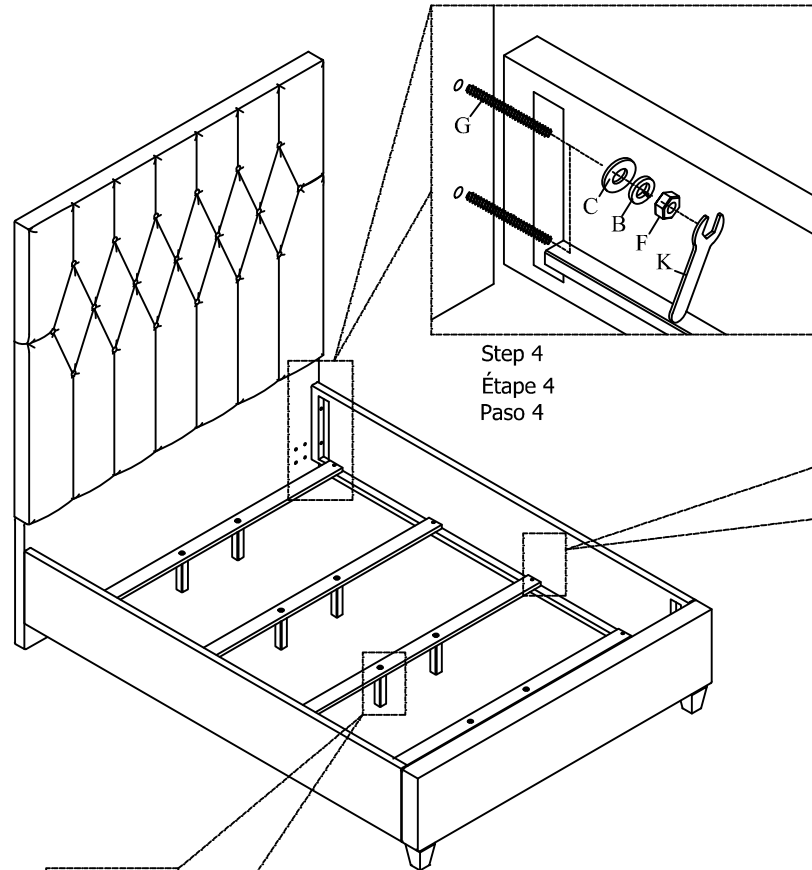







Phillips head screwdriver / Not included  
Tournevis Phillips / Non compris  
Destornillador de estrella / No incluido

Step 4  
Étape 4  
Paso 4

Step 5  
Étape 5  
Paso 5

Step 6  
Étape 6  
Paso 6

**Hardware List of Side Rail/ Slat**  
**Liste des pièces de quincaillerie de Traverse/ Latte**  
**Lista de materiales de Travesaño lateral/ Listone**

No.	Drawing No.	Description	Quantity
No.	Illustration No.	La Description	Quantité
No.	Esquema	Descripción	Cantidad
B		Ø5/16"*Ø11*1.5 Lock washer/ Rondelle de blocage/ Arandela de seguridad	8PCS
C		Ø5/16"*Ø19*2 Flat washer/ Rondelle plate/ Arandela plana	8PCS
F		Ø5/16"Nut/ Écrou/ Tuerca	8PCS
G		Ø5/16"3-1/2" Hanger Bolt/ Boulon-vis/Perno de suspensión	8PCS
H		M4*32mm Screw/ Vis/ Tornillo	8PCS
K		12mm Open Wrench/ Clé à fourche/ Llave de boca	1PC