





# BECKETT NIGHTSTAND

Assembly instructions:

**PARTS LIST**

No.	DESCRIPTION	IMAGE	QTY
P1	TOP CABINET		1
P2	LEG		4
P3	BOTTOM PANEL		1
P4	FEET		4

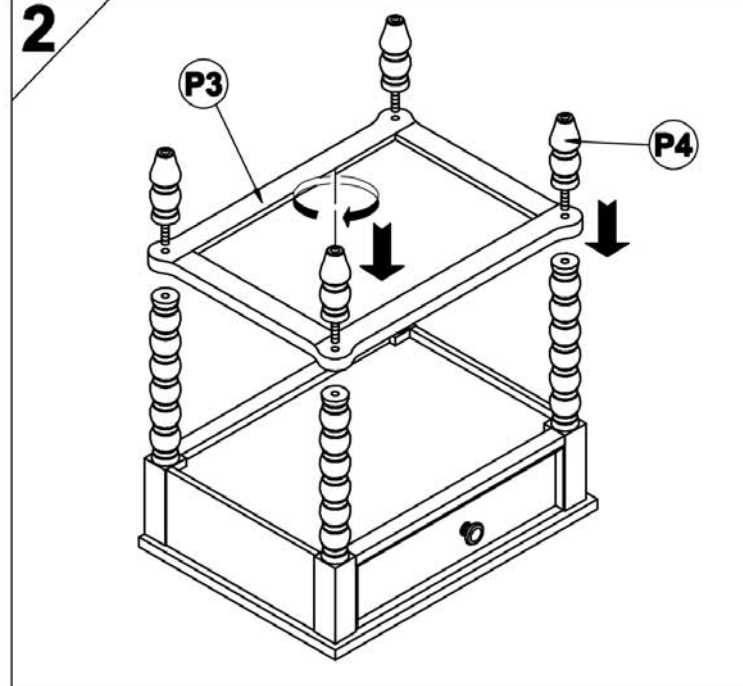
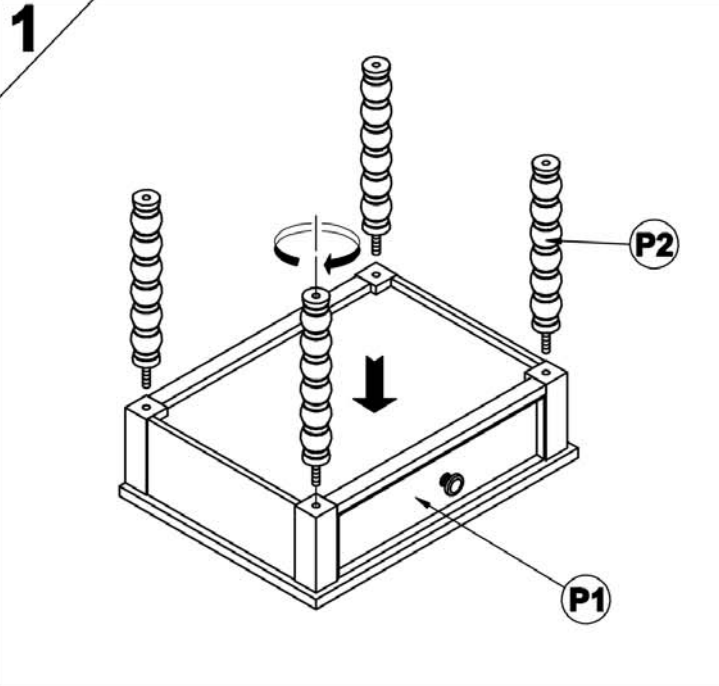

**NOTE:** PO# is located underneath/ at the back side of each item. Please be prepared to provide this # should any claim be necessary.

**CAUTION:** Item is heavy assembly should be performed by two people.

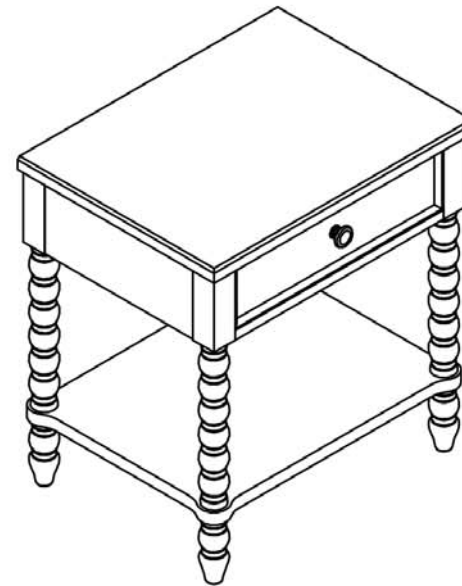

**ASSEMBLED COMPLETE**